

福島県
シェッド・シェルター
長寿命化修繕計画
(個別施設計画)



令和2年3月
福島県 土木部 道路管理課

目次

第1章	福島県シェッド・シェルター長寿命化修繕計画の概要	- 1 -
1-1	計画策定の経緯	- 1 -
1-2	目的	- 1 -
1-3	維持管理の考え方	- 1 -
第2章	県内シェッド・シェルターの現状と課題	- 2 -
2-1	福島県のシェッド・シェルター基本情報	- 2 -
	(1)建設本数と管理延長	- 2 -
	(2)シェッド・シェルター一覧	- 2 -
2-2	シェッド・シェルター点検結果	- 4 -
	(1)シェッド・シェルター点検の概要	- 4 -
	(2)構造種別ごとの点検箇所	- 4 -
	(3)主な変状と概要	- 9 -
	(4)平成26年～平成30年点検の結果概要	- 9 -
	(5)平成26年～平成30年点検結果(判定区分)	- 24 -
	(6)変状分析	- 25 -
2-3	シェッド・シェルター維持管理上の課題	- 26 -
	(1)厳しい自然条件	- 26 -
	(2)シェッド・シェルターの老朽化	- 26 -
第3章	シェッド・シェルター維持管理計画と個別施設計画	- 27 -
3-1	目標の整理と修繕方針	- 27 -
	(1)目標の整理	- 27 -
	(2)修繕方針	- 27 -
	(3)対策工法の整理	- 27 -
3-2	補修優先度と補修サイクル	- 28 -
	(1)補修優先度	- 28 -
	(2)補修・更新サイクル	- 28 -
3-3	シェッド・シェルターの個別施設計画(修繕計画)	- 29 -
	(1)個別施設計画(修繕計画)	- 29 -
第4章	今後の方針	- 35 -
4-1	今後の点検・修繕の実施方針	- 35 -
	(1)今後の点検について	- 35 -
	(2)今後の修繕について	- 35 -

第1章 福島県シェッド・シェルター長寿命化修繕計画の概要

1-1 計画策定の経緯

シェッド・シェルターは、雪崩・落石・吹雪等による道路利用者への被害を防止するために道路に設置する構造物である。福島県は 172 箇所、延長約 35km のシェッド・シェルターを管理している(平成 31 年度 3 月現在)。これらのシェッド・シェルターのうち、全本数の 32%にあたる 56 箇所において建設から 30 年が経過しており、老朽化に伴う維持管理費の増加が想定されることから、表 1-1 に示す計画を策定し、これまで効率的な維持管理の実施に努めてきた。

シェッド・シェルター点検については、平成 26 年 7 月 1 日に施行された道路法施行規則により、5 年に一度の近接目視による定期点検(以下、法点検)が義務付けられたことから、本県でも点検を実施しているところである。

本計画は、平成 26 年～平成 30 年に実施した 1 巡目法点検の結果を踏まえ、今後の修繕事業実施のために、「福島県シェッド・シェルター長寿命化修繕計画(令和2年版)」として策定するものである。

表 1-1 維持管理計画の策定経緯

計画名	策定年度	備考
福島県アセットマネジメント(第 2: 構造物部門)	平成 19 年 3 月	
福島県道路長寿命化計画(第 2: 構造物部門)	平成 23 年 3 月	平成 28 年 3 月改訂

1-2 目的

本計画は、シェッド・シェルターの損傷状況や路線の重要度等を基に、修繕優先度および修繕費用等を明確化することで、維持管理予算に制約がある中においても、利用者に被害を及ぼすことがなく、快適な利用を継続できるよう、シェッド・シェルターを適切に維持管理するために策定するものである。

なお、本計画で取り扱うシェッド・シェルターは、平成 30 年度までに定期点検を完了した 172 箇所である。

1-3 維持管理の考え方

シェッド・シェルターの維持管理においては、道路法施行規則第四条の五の六(平成 26 年 7 月 1 日施行)により、5 年に一度の近接目視の定期点検が義務付けられ、本県でもシェッド・シェルター本体の損傷状況(Ⅰ:健全、Ⅱ:予防保全段階、Ⅲ:早期措置段階、Ⅳ:緊急措置段階)を記録し、修繕対象の目安としている。また、法点検の範囲外となる電気関係の付属物については、「設備定期点検」により動作状況等を確認している。

福島県のシェッド・シェルター維持管理においては、「予防保全」を採用している。シェッド・シェルターは降雨や降雪により常に浸食作用を受けており、損傷状況によって補修工法・費用が異なることから、損傷の小さいうちに予防保全的な措置を行うことで、維持管理に係るトータルコストの最小化を図るものである。

第2章 県内シェッド・シェルターの現状と課題

2-1 福島県のシェッド・シェルター基本情報

(1) 建設本数と管理延長

福島県が管理するシェッド・シェルター建設本数および累積延長の推移を図 2-1 に示す。
 福島県の管理するシェッド・シェルターは、平成 31 年 3 月現在で 172 箇所あり、延長は約 35km である。建設本数は 1995 年から 2004 年の 10 年間で最も多く、全体の約5割がこの間に建設されている。





図 2-1 福島県管理のシェッド・シェルター数と管理延長の推移

(2) シェッド・シェルター一覧

福島県が管理するシェッド・シェルター一覧を図 2-2 に示す。

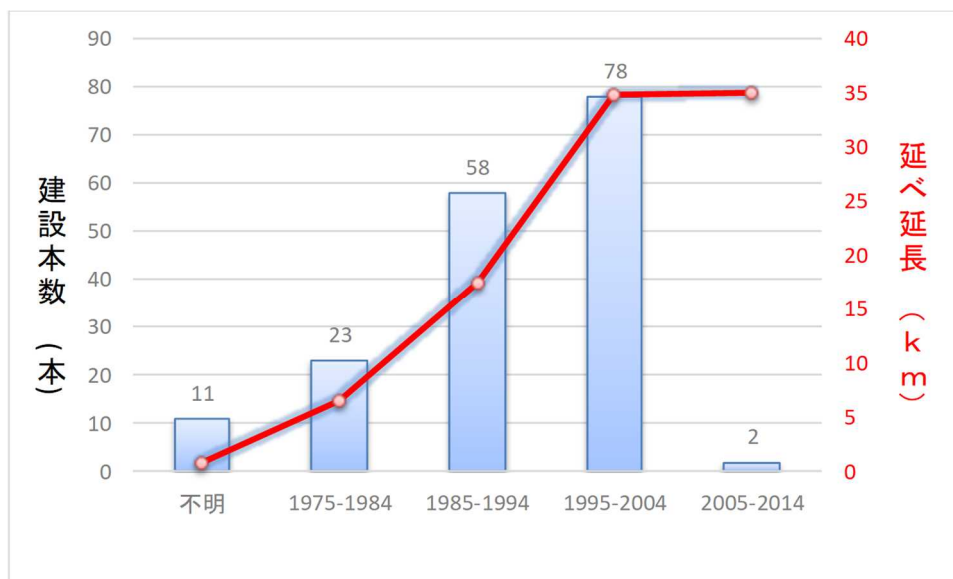
各地方のシェッド・シェルター数は、会津で 166 箇所、中通りで 4 箇所、浜通りで 2 箇所であり、ほとんどのシェッド・シェルターが会津地方に位置する。また、種類ごとに区分すると下表の通りである。

表 2-1 シェッド・シェルターの種類

		
<u>スノーシェッド(120 箇所)</u> 走行車両を雪崩等から守る施設	<u>スノーシェルター(26 箇所)</u> 走行車両を吹雪等から守る施設(視距確保)	<u>ロックシェッド(26 箇所)</u> 走行車両を落石等から守る施設

2-2 シェッド・シェルター点検結果

(1) シェッド・シェルター点検の概要

法点検実施要領に基づき、近接目視を基本として状態の把握を行う。シェッド・シェルター一本体について表 2-2 のⅠ～Ⅳの4区分にて健全性を診断する。

表 2-2 シェッド・シェルター本体の健全性判定区分

区分		内容
Ⅰ	健全	機能に支障が生じていない状態
Ⅱ	予防保全段階	機能に支障が生じていないが、予防保全の観点から措置を講ずることが望ましい状態
Ⅲ	早期措置段階	機能に支障が生じる可能性があり、早期に措置を講ずべき状態
Ⅳ	緊急措置段階	機能に支障が生じている、または生じる可能性が著しく高く、緊急に措置を講ずべき状態

(2) 構造種別ごとの点検箇所

シェッド・シェルターを構造種ごとに区分すると、コンクリート構造(RC)、コンクリート構造(PC)、鋼構造の3種に大別される。

福島県内のシェッド・シェルターは、表 2-3 に示すように、コンクリート構造(RC)8箇所、コンクリート構造(PC)112箇所、鋼構造 52箇所からなる。鋼構造物 52箇所のうちシェッドが 26箇所、シェルターが 26箇所である。

表 2-3 福島県内シェッド・シェルターの構造種別数

種別	構造物名	対策の対象	箇所数
1)コンクリート構造(RC)	シェッド	雪崩、落石	8
2)コンクリート構造(PC)	シェッド	雪崩、落石	112
3)鋼構造	シェッド	雪崩、落石	26
	シェルター	吹雪、吹き溜まり	26

以下1)～4)に構造物ごとの点検箇所と損傷例を示す。

1) コンクリート構造 (RC) の点検箇所と損傷例

図 2-3、表 2-4 に RC 構造の点検箇所と損傷例を示す。



図 2-3 コンクリート構造(RC)一般図

表 2-4 コンクリート構造(RC)の点検箇所と損傷例

点検箇所 (部材・部位)		劣化・損傷の種類			備考
		鋼	コンクリート	その他	
1	壁部 (谷側、山側)	——	ひびわれ、うき・剥離・鉄筋露出、漏水・遊離石灰、滞水、変形・欠損	沈下・移動・傾斜	主部材
2	頂版部 (外側、内空)	——	ひびわれ、うき・剥離・鉄筋露出、漏水・遊離石灰、抜け落ち、滞水、変形・欠損	——	主部材
3	道路舗装	——	——	舗装の異常	
4	排水工	——	——	漏水・滞水、変形・欠損、土砂詰り	
5	雪底防止柵、土留壁	腐食、ゆるみ・脱落、防食機能の劣化、変形・欠損	ひびわれ、うき・剥離・鉄筋露出、漏水・遊離石灰、滞水、変形・欠損	——	

2) コンクリート構造(PC)の点検箇所と損傷例

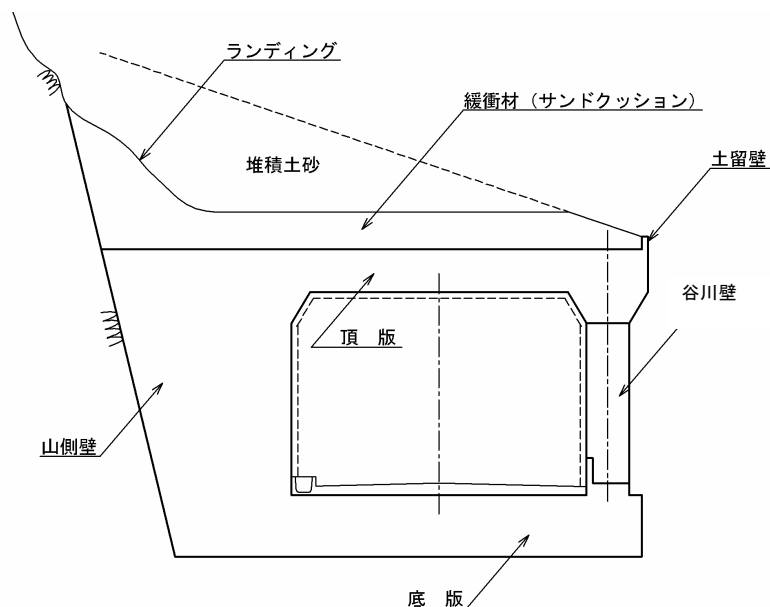
図 2-4、表 2-5 に PC 構造の点検箇所と損傷例を示す。



図 2-4 コンクリート構造(PC)一般図

表 2-5 コンクリート構造(PC)の点検箇所と損傷例

点検箇所 (部材・部位)		劣化・損傷の種類			備考
		鋼	コンクリート	その他	
1	支承接合部	腐食、ゆるみ・脱落、防食機能の劣化、変形・欠損	ひびわれ、うき・剥離・鉄筋露出、漏水・遊離石灰、滞水、変形・欠損	—	主部材
2	柱部、受台部	—	ひびわれ、うき・剥離・鉄筋露出、漏水・遊離石灰、滞水、変形・欠損	沈下・移動・傾斜	主部材
3	主梁部	—	—	—	主部材
4	床版 (内空、屋根)	—	ひびわれ、うき・剥離・鉄筋露出、漏水・遊離石灰、抜け落ち、滞水、変形・欠損	—	主部材
5	PC 鋼材定着部	—	ひびわれ、うき・剥離・鉄筋露出、漏水・遊離石灰、抜け落ち、滞水、変形・欠損	—	主部材
6	道路舗装	—	—	舗装の異常	
7	排水工	—	—	漏水・滞水、変形・欠損、土砂詰り	
8	雪庇防止柵、土留壁	腐食、ゆるみ・脱落、防食機能の劣化、変形・欠損	ひびわれ、うき・剥離・鉄筋露出、漏水・遊離石灰、滞水、変形・欠損	—	

3) 鋼構造(シェッド)の点検箇所と損傷例

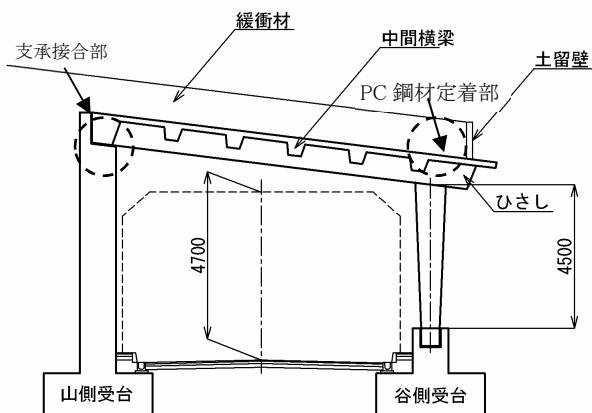
図 2-5、表 2-6 に鋼構造(シェッド)の点検箇所と損傷例を示す。



図 2-5 鋼構造(シェッド)一般図

表 2-6 鋼構造(シェッド)の点検箇所と損傷例

点検箇所 (部材・部位)		劣化・損傷の種類			備考
		鋼	コンクリート	その他	
1	支承接合部 (谷側、山側)	腐食、ゆるみ・脱落、防食機能の劣化、変形・欠損	ひびわれ、うき・剥離・鉄筋露出、漏水・遊離石灰、滞水、変形・欠損	——	主部材
2	柱部	腐食、亀裂、ゆるみ・脱落、破断、防食機能の劣化、変形・欠損	——	沈下・移動・傾斜	主部材
3	主梁部	腐食、ゆるみ・脱落、防食機能の劣化、変形・欠損	——	——	主部材
4	床版 (内空、屋根)	腐食、ゆるみ・脱落、防食機能の劣化、漏水・滞水、変形・欠損	——	——	主部材
5	受台 (谷側、山側)	——	ひびわれ、うき・剥離・鉄筋露出、漏水・遊離石灰、滞水、変形・欠損	——	主部材
6	道路舗装	——	——	舗装の異常	
7	排水工	——	——	漏水・滞水、変形・欠損、土砂詰り	
8	雪庇防止柵、土留壁	腐食、ゆるみ・脱落、防食機能の劣化、変形・欠損	——	——	

4) 鋼構造(シェルター)の点検箇所と損傷例

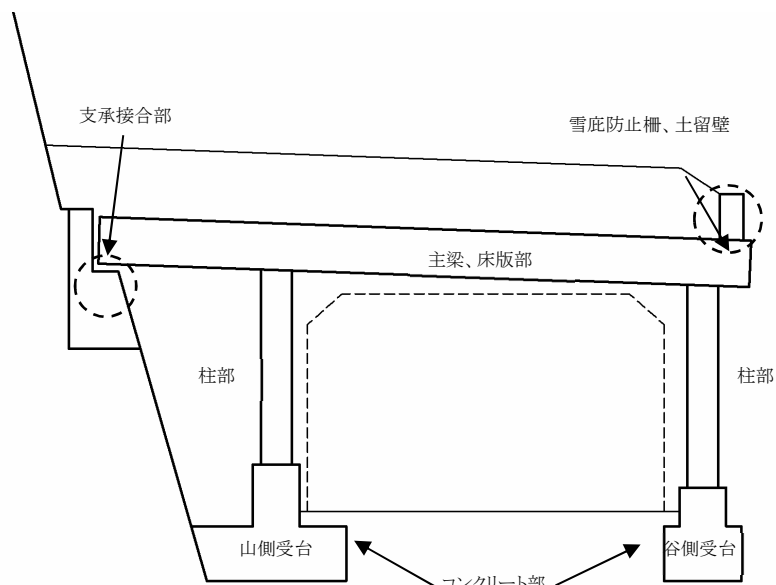
図 2-6、表 2-7 に鋼構造(シェルター)の点検箇所と損傷例を示す。



図 2-6 鋼構造(シェルター)一般図

表 2-7 鋼構造(シェルター)の点検箇所と損傷例

点検箇所 (部材・部位)		劣化・損傷の種類			備考
		鋼	コンクリート	その他	
1	支柱・桁材部	腐食、亀裂、ゆるみ・脱落、破断、防食機能の劣化、変形・欠損	——	沈下・移動・傾斜	主部材
2	覆工板	——	——	——	主部材
3	コンクリート壁部	——	ひびわれ、うき・剥離・鉄筋露出、漏水・遊離石灰、滞水、変形・欠損	沈下・移動・傾斜	主部材
4	道路舗装	——	——	舗装の異常	
5	排水工	——	——	漏水・滞水、変形・欠損、土砂詰り	
6	雪庇防止柵	腐食、ゆるみ・脱落、防食機能の劣化、変形・欠損	——	——	

(3) 主な変状と概要

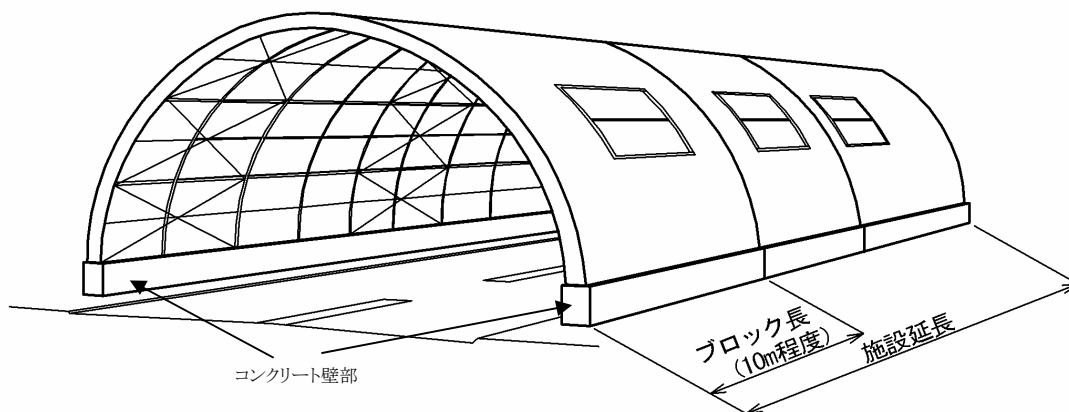
シェッド・シェルターに発生する主な変状とその概要を表 2-8 に示す。変状の種類を大別すると、腐食、ひび割れ、うき・剥離、漏水に分けられる。

表 2-8 主な変状とその概要

変状の種類	関連する要求性能	概要
腐食 ひび割れ うき・剥離	シェッド・シェルターの構造安定性	・腐食、ひび割れ、うき・剥離により主部材に損傷が生じると、シェッド・シェルターの構造耐力に影響し、将来的に崩落へつながる恐れがある。箇所や状況から判断し、必要に応じて詳細調査を行う必要がある。
うき・剥離	利用者の安全性	・ひび割れが閉合してうきになった場合や、補修材が劣化した場合、その塊が落下してシェッド・シェルター利用者に危害が及ぶ可能性がある。
漏水	利用者の安全性	・漏水は主に背後斜面からの流水によるもので、漏水量が多い場合には、シェッド・シェルター利用者に危害が及ぶ可能性がある。 ・凍結してつららや氷盤となった場合には、落下による利用者被害の恐れがある。

(4) 平成 26 年～平成 30 年点検の結果概要

平成 26 年～平成 30 年の 1 巡目点検結果について、点検結果一覧を表 2-9～表 2-22 に示す。

表 2-9 H26～H30 シェッド・シェルター点検結果一覧(1/14)

簡元	施設名										点検計画															点検結果													写真	部材										
	シェッド No	シェッド名	ブガナ	路線名	完成年度(西暦)	2019現在経過年数	延長(m)	管理事務所名	市区町村名	H26	H27	H28	H29	H30	R1	R2	R3	R4	R5	点検実施年度	判定区分		構造ごとの判定区分								要因																			
																					判定区分	上部構造				下部構造				他				上部構造		下部構造					支	他								
																						主梁	横梁	頂版	壁・柱	受台	谷側基礎	支	他	主梁	横梁	頂版	壁・柱	受台	谷側基礎	支	他													
H26年度～	H30年度	・I ・II ・III ・IV	・I ・II ・III ・IV	・I ・II ・III ・IV	・I ・II ・III ・IV	・I ・II ・III ・IV	・I ・II ・III ・IV	・I ・II ・III ・IV	・I ・II ・III ・IV	・I ・II ・III ・IV	・I ・II ・III ・IV	・I ・II ・III ・IV	・I ・II ・III ・IV	・I ・II ・III ・IV	・I ・II ・III ・IV	・I ・II ・III ・IV	・I ・II ・III ・IV	・I ・II ・III ・IV	・I ・II ・III ・IV	・I ・II ・III ・IV	原因	原因	原因	原因	原因	原因	原因	原因	原因																					
0101	角間下ロックシェッド	カマシカウシェッド	国道399号	1983	36	102	県北建設事務所	福島市					○							○	H30年度	II				II	II	II	I	I										うき・剥離	ひび割れ				土砂詰まり	RC				
0201	三王版スノーシェルター	サンウザカスノーシェルター	国道294号	2002	17	148	県中建設事務所	郡山市					○							○	H31年度	II						II														ひび割れ				M				
0301	関岡ロックシェッド	セキカウシェッド	国道118号	不明		39.5	棚倉土木事務所	矢祭町					○							○	H30年度	II	I	I	II	I	I	II	I	II											漏水		漏水		土砂堆積	M				
0302	赤面スノーシェッド	アカサネスノーシェッド	一般県道須甲子線	不明		10.2	県南建設事務所	西郷村					○							○	H30年度	II			II	II	II			II	II										腐食	腐食	腐食	うき・剥離	腐食	ひび割れ、舗装の異常、錆び・腐食	M			
0401	新平スノーシェッド	シラヘラズノーシェッド	国道121号	1993	26	76	喜多方建設事務所	喜多方市					○							○	H29年度	III		I	II	II	III	III	I	I	II											腐食	腐食	うき・剥離	防水工・縁石・畜産防止柵・転落防止柵・ガードレール	PC				
0402	桜峠1号シェルター	サクラウゲ1ゴウシェルター	国道459号	1993	26	171.2	喜多方建設事務所	北塩原村					○							○	H29年度	III	I	II	II	II	III	I	III	II											腐食	腐食	腐食	うき・剥離	その他	交通安全施設	M			
0403	桜峠2号シェルター	サクラウゲ2ゴウシェルター	国道459号	1993	26	81.6	喜多方建設事務所	北塩原村					○							○	H29年度	III	I	II	III	II	II	I	III	III											腐食	漏水	腐食	ひび割れ	その他	舗装・側溝蓋	M			
0404	桜峠3号シェルター	サクラウゲ3ゴウシェルター	国道459号	1993	26	111.6	喜多方建設事務所	北塩原村					○							○	H29年度	III	I	II	III	I	II	I	II	I											腐食	腐食	うき・剥離	その他	M					
0405	不動スノーシェッド	フドウスノーシェッド	国道459号	1987	32	308.1	喜多方建設事務所	喜多方市					○							○	H29年度	III	III	III	II	II	II	I	I	II											うき・剥離	うき・剥離	漏水	ひび割れ	ひび割れ	縁石・畜産防止柵	PC			
0406	槻ノ木平スノーシェッド	ツキノキヘラズノーシェッド	国道459号	1995	24	152.4	喜多方建設事務所	喜多方市					○							○	H29年度	III	II	III	II	II	II	I	III	II												うき・剥離	漏水	ひび割れ	ひび割れ	うき・剥離	うき・剥離	縁石・防水工	PC	
0407	釜の脇スノーシェッド	カマノキスノーシェッド	主要地方道喜多方・西会津線	1990	29	374.2	喜多方建設事務所	西会津町					○							○	H29年度	III	III	III	II	III	II	I	I	III												うき・剥離	うき・剥離	ひび割れ	ひび割れ		防水工・側溝蓋	PC		
0408	五万堂ロックシェッド	ゴマンドウロックシェッド	主要地方道猪苗代・湖南線	2001	18	754.9	猪苗代土木事務所	猪苗代町					○							○	H31年度	II		II				II		I	II												ひび割れ		ひび割れ		腐食・漏水 舗装の異常、ひび割れ、変状	PC		
0409	飯根スノーシェッド	イヘスノーシェッド	一般県道飯根加納・山部・西会津線	1989	30	112	喜多方建設事務所	西会津町					○							○	H29年度	II	II	I	II	II	II	I	I	II														ひび割れ	ひび割れ	ひび割れ	ひび割れ		転落防止柵・舗装	PC

表 2-11 H26～H30 シェッド・シェルター点検結果一覧(3/14)

施設名	施設種別	路線名	完成年度 (西暦)	2019 現在 経過年数	延長(m)	管理事務所名	市区町村名	点検計画															点検結果														写真	部材				
								判定区分															判定区分																			
								判定区分															上部構造							下部構造			支承						他			
								H26	H27	H28	H29	H30	R1	R2	R3	R4	R5	点検実施 年度	判定区分	主梁	横梁	頂版	壁・柱	受台	谷側 基礎	支承	他	主梁	横梁	頂版	壁・柱	受台	谷側 基礎	支承	他							
0512	滝第2スノーシェルター	ササゲスノーシェルター	国道252号	1992	27	199.7	宮下土木事務所	金山町		○										H27年度	Ⅲ	Ⅰ	Ⅰ	Ⅰ	Ⅰ	Ⅰ	Ⅰ	Ⅰ	Ⅲ											変形・欠損		RC PC M
0513	大深沢スノーシェッド	オオカガリスノーシェッド	国道252号	1981	38	541.3	宮下土木事務所	金山町		○										H27年度	Ⅲ	Ⅰ	Ⅰ	Ⅰ	Ⅲ	Ⅰ	Ⅰ	Ⅲ	Ⅱ							腐食		腐食	腐食・変形・ 欠損		M	
0514	下大牧第1スノーシェッド	シモオホキダイスノーシェッド	国道252号	1985	34	242.3	宮下土木事務所	金山町		○										H27年度	Ⅲ	Ⅲ	Ⅲ	Ⅲ	Ⅲ	Ⅰ	Ⅰ	Ⅰ	Ⅲ	腐食	腐食	腐食	腐食					腐食			M	
0515	駒崎瀬スノーシェルター	コマカセスノーシェルター	国道252号	1989	30	333.5	宮下土木事務所	三島町		○										H27年度	Ⅲ	Ⅰ	Ⅰ	Ⅰ	Ⅰ	Ⅰ	Ⅰ	Ⅰ	Ⅱ										変形・欠損		M	
0516	早戸第2兼用スノーシェット	ハセトダイカノヨウスノーシェット	国道252号	1991	28	416.5	宮下土木事務所	三島町		○										H27年度	Ⅲ	Ⅰ	Ⅲ	Ⅰ	Ⅲ	Ⅰ	Ⅰ	Ⅰ	Ⅱ							うき・ 剥離	うき・ 剥離		変形・欠損、 舗装の異常、 路面の凹凸、 腐食		PC	
0517	持寄第1スノーシェッド	モチヨシダイスノーシェット	国道252号	1988	31	561.3	宮下土木事務所	柳津町		○										H27年度	Ⅲ	Ⅲ	Ⅲ	Ⅰ	Ⅲ	Ⅰ	Ⅰ	Ⅲ	Ⅲ	うき・ 剥離	うき・ 剥離		腐食		うき・ 剥離	漏水・遊離 石灰				PC		
0518	持寄スノーシェルター	モチヨシスノーシェルター	国道252号	1991	28	167.7	宮下土木事務所	柳津町		○										H27年度	Ⅰ	Ⅰ	Ⅰ	Ⅰ	Ⅰ	Ⅰ	Ⅰ	Ⅰ	Ⅰ												M	
0519	川井スノーシェルター	カワイスノーシェルター	国道252号	不明		97.6	宮下土木事務所	三島町		○										H27年度	Ⅲ	Ⅰ	Ⅰ	Ⅰ	Ⅰ	Ⅰ	Ⅲ	Ⅱ									腐食	腐食		M		
0520	高清水スノーシェッド	タカシズスノーシェット	国道252号	1995	24	630.9	宮下土木事務所	三島町		○										H27年度	Ⅲ	Ⅲ	Ⅲ	Ⅰ	Ⅲ	Ⅰ	Ⅰ	Ⅲ	Ⅲ	うき・ 剥離	うき・ 剥離								変形・欠損		PC	
0521	高清水第2スノーシェッド	タカシズダイ2スノーシェット	国道252号	2003	16	279.7	宮下土木事務所	三島町		○										H27年度	Ⅲ	Ⅲ	Ⅲ	Ⅰ	Ⅲ	Ⅰ	Ⅰ	Ⅲ	Ⅲ	うき・ 剥離	うき・ 剥離	うき・ 剥離		ひび 割れ					変形・欠損		PC	
0522	高倉スノーシェッド	タカクラスノーシェット	国道252号	1986	33	83.8	宮下土木事務所	金山町		○										H27年度	Ⅲ	Ⅲ	Ⅰ	Ⅰ	Ⅲ	Ⅰ	Ⅰ	Ⅰ	Ⅱ	うき・ 剥離			うき・ 剥離						変形・欠損		PC	
0523	名入スノーシェット	ナイルスノーシェット	国道252号	1999	20	354.6	宮下土木事務所	三島町		○										H27年度	Ⅲ	Ⅲ	Ⅰ	Ⅰ	Ⅰ	Ⅰ	Ⅰ	Ⅱ	うき・ 剥離										変形・欠損		PC	
0524	椋原第1スノーシェット	ヒナハラダイ1スノーシェット	国道252号	1995	24	513.8	宮下土木事務所	三島町		○										H28年度	Ⅲ	Ⅲ	Ⅱ		Ⅱ	Ⅰ	Ⅰ	Ⅰ	Ⅱ	うき・ 剥離	うき・ 剥離		うき・ 剥離						変形・欠損		PC	

表 2-12 H26～H30 シェッド・シェルター点検結果一覧(4/14)

精元	施設名								点検計画														点検結果											写真	部材																																																																																																																																																																																																																																																																																																																																																																																																																																																																																																																																																																																																																																																																																																																																																																																																																																																																																																																																																																																																																																																																																																																																																																																																																																																					
									判定区分														構造ごとの判定区分																																																																																																																																																																																																																																																																																																																																																																																																																																																																																																																																																																																																																																																																																																																																																																																																																																																																																																																																																																																																																																																																																																																																																																																																																																																																	
									判定区分														上部構造				下部構造				支保					他			要因																																																																																																																																																																																																																																																																																																																																																																																																																																																																																																																																																																																																																																																																																																																																																																																																																																																																																																																																																																																																																																																																																																																																																																																																																																																	
									H26	H27	H28	H29	H30	R1	R2	R3	R4	R5	点検実施年度	判定区分	主梁	横梁	頂版	壁・柱	受台	谷側基礎	支保	他	主梁	横梁	頂版	壁・柱	受台			谷側基礎	支保	他	要因	要因	要因	要因	要因	要因	要因																																																																																																																																																																																																																																																																																																																																																																																																																																																																																																																																																																																																																																																																																																																																																																																																																																																																																																																																																																																																																																																																																																																																																																																																																																											
0525	松原スノーシェッド	ヒノハラスノーシェッド	国道252号	1995	24	368.5	宮下土木事務所	三島町																																																																																																																																																																																																																																																																																																																																																																																																																																																																																																																																																																																																																																																																																																																																																																																																																																																																																																																																																																																																																																																																																																																																																																																																																																																																																

表 2-13 H26～H30 シェッド・シェルター点検結果一覧(5/14)

種別	施設名								点検計画																点検結果										写真	部材							
	シェッド No	シェッド名	ブリック	路線名	完成年度(西暦)	2019現在 経過年数	延長(m)	管理事務所名	市区町村名	判定区分		構造ごとの判定区分								要因																							
										H26	H27	H28	H29	H30	R1	R2	R3	R4	R5	点検実施 年度	判定区分	上部構造				下部構造				上部構造							下部構造					支 承	他
																						主梁	横梁	頂版	壁・ 柱	受台	谷側 基礎	支 承	他	主梁	横梁	頂版	壁・ 柱	受台			谷側 基礎	支 承	他				
0538	牧沢スノーシェッド	マキワスノーシェッド	国道400号	1975	44	223.2	宮下土木事務所	金山町	○																											変形・欠損、 防水工剥れ	PC						
0539	舟鼻スノーシェルター	フナバスノーシェルター	国道400号	1992	27	38.5	宮下土木事務所	昭和村	○																										変形・欠損	M							
0540	小見沢スノーシェッド	玉サワスノーシェッド	国道400号	1989	30	80.7	宮下土木事務所	昭和村	○																										変形・欠損	PC							
0541	小見沢第1スノーシェッド	玉サワ第1スノーシェッド	国道400号	1997	22	262.7	宮下土木事務所	昭和村	○																										変形・欠損、 舗装の異常	PC							
0542	小見沢第2スノーシェッド	玉サワ第2スノーシェッド	国道400号	2003	16	110.4	宮下土木事務所	昭和村	○																										変形・欠損	PC							
0543	白森山スノーシェッド	シロヤマスノーシェッド	国道400号	1999	20	110.2	宮下土木事務所	昭和村	○																										舗装の異常	PC							
0544	松坂1号スノーシェルター	マツザカ1号スノーシェルター	国道401号	1990	29	34	会津若松建設事務所	会津美里町																												その他 ひび割れ	M						
0545	松坂2号スノーシェルター	マツザカ2号スノーシェルター	国道401号	1990	29	30.7	会津若松建設事務所	会津美里町																											その他 ひび割れ	M							
0546	松坂3号スノーシェルター	マツザカ3号スノーシェルター	国道401号	1990	29	38.9	会津若松建設事務所	会津美里町																											その他 ひび割れ	M							
0547	喰丸第1スノーシェッド	クイマル第1スノーシェッド	国道401号	1996	23	191.2	宮下土木事務所	昭和村																												その他 ひび割れ	PC						
0548	喰丸第2スノーシェッド	クイマル第2スノーシェッド	国道401号	2002	17	252	宮下土木事務所	昭和村																											うき・ 剥離	ひび割れ	PC						
0549	喰丸スノーシェルター(起 点側)	クイマルスノーシェルター	国道401号	1995	24	150.1	宮下土木事務所	昭和村																											ひび割れ	変形・欠損	M						
0550	喰丸スノーシェルター(終 点側)	クイマルスノーシェルター	国道401号	1995	24	220.7	宮下土木事務所	昭和村																											ひび割れ	変形・欠損	M						

表 2-19 H26～H30 シェッド・シェルター点検結果一覧(11/14)

精元 シェッド No	施設名 シェッド名 フシナ		路線名	完成年度 (西暦)	2019現在 経過年数	延長(m)	管理事務所名	市区町村名	点検計画															点検結果											写真	部材												
									点検計画															判定区分				構造ごとの判定区分									要因											
									H26	H27	H28	H29	H30	R1	R2	R3	R4	R5	点検実施 年度	判定区分	上部構造				下部構造			支承		他	上部構造			下部構造			支承	他										
																					主梁	横梁	頂版	壁・柱	受台	谷側 基礎	支	承	主梁		横梁	頂版	壁・柱	受台					谷側 基礎									
											・H26年度 ・H30年度	・Ⅰ ・Ⅱ ・Ⅲ ・Ⅳ	・Ⅰ ・Ⅱ ・Ⅲ ・Ⅳ	・Ⅰ ・Ⅱ ・Ⅲ ・Ⅳ	・Ⅰ ・Ⅱ ・Ⅲ ・Ⅳ	・Ⅰ ・Ⅱ ・Ⅲ ・Ⅳ	・Ⅰ ・Ⅱ ・Ⅲ ・Ⅳ	・Ⅰ ・Ⅱ ・Ⅲ ・Ⅳ	・Ⅰ ・Ⅱ ・Ⅲ ・Ⅳ	・Ⅰ ・Ⅱ ・Ⅲ ・Ⅳ	・Ⅰ ・Ⅱ ・Ⅲ ・Ⅳ	・Ⅰ ・Ⅱ ・Ⅲ ・Ⅳ	・Ⅰ ・Ⅱ ・Ⅲ ・Ⅳ	・Ⅰ ・Ⅱ ・Ⅲ ・Ⅳ	・Ⅰ ・Ⅱ ・Ⅲ ・Ⅳ	・Ⅰ ・Ⅱ ・Ⅲ ・Ⅳ	・Ⅰ ・Ⅱ ・Ⅲ ・Ⅳ	・Ⅰ ・Ⅱ ・Ⅲ ・Ⅳ	・Ⅰ ・Ⅱ ・Ⅲ ・Ⅳ	・Ⅰ ・Ⅱ ・Ⅲ ・Ⅳ																		
0649	叶津スノーシェッド	カウナスノーシェッド	国道289号	1995	24	370	山口土木事務所	只見町																																								
0650	平石山スノーシェッド	ライヤマスノーシェッド	国道289号	1996	23	104.3	山口土木事務所	只見町																					○	H30年度	Ⅱ	Ⅰ	Ⅰ	Ⅱ	Ⅰ	Ⅱ	Ⅱ	Ⅰ	Ⅱ	ひび割れ	ひび割れ	ひび割れ	ひび割れ		頂部外側 目地部土砂 堆積			PC
0651	乗取ロックシェッド	ヤナリロックシェット	国道289号	1996	23	103.7	山口土木事務所	只見町																					○	H28年度	Ⅲ	Ⅰ	Ⅱ	Ⅰ	Ⅲ	Ⅰ	Ⅰ	Ⅱ	ひび割れ		ひび割れ			舗装の異常、変形等			PC	
0652	界ロックシェッド	サカイロックシェット	国道289号	不明		150	山口土木事務所	南会津町																						H29年度	Ⅲ	Ⅰ	Ⅱ	Ⅱ	Ⅰ	Ⅱ	Ⅱ	Ⅰ	Ⅱ	ひび割れ	ひび割れ	ひび割れ	ひび割れ		腐食防止層 の遊離石灰			PC
0653	山ロスノーシェッド	ヤマゲタスノーシェット	国道289号	1994	25	149.6	山口土木事務所	南会津町																					○	H28年度	Ⅲ	Ⅰ	Ⅲ	Ⅲ	Ⅰ	Ⅲ	Ⅱ	Ⅰ	Ⅲ	ひび割れ	うき・剥離	ひび割れ	その他		うき、変形・ 欠損			PC
0654	鳴滝スノーシェッド①	ナルタスノーシェット①	国道352号	1985	34	211	山口土木事務所	檜枝岐村																					○	H28年度	Ⅲ	Ⅲ	Ⅲ	Ⅲ	Ⅲ	Ⅲ	Ⅲ	Ⅲ	うき・剥離	うき・剥離	ひび割れ	ひび割れ		舗装の異常			PC	
0655	鳴滝スノーシェッド②	ナルタスノーシェット②	国道352号	1985	34	375	山口土木事務所	檜枝岐村																					○	H28年度	Ⅲ	Ⅲ	Ⅲ	Ⅲ	Ⅲ	Ⅲ	Ⅲ	Ⅲ	腐食	その他	その他	ひび割れ	うき・剥離	その他	舗装の異常			M
0656	小立岩スノーシェッド	コタテイワスノーシェット	国道352号	1975	44	122.7	山口土木事務所	南会津町																					○	H28年度	Ⅲ	Ⅲ	Ⅲ	Ⅲ	Ⅲ	Ⅲ	Ⅲ	Ⅲ	うき・剥離	うき・剥離	ひび割れ	うき・剥離	ひび割れ	ひびわれ、 変形・欠損			PC	
0657	小豆温泉第1スノーシェット	アノキオセダイ1スノーシェット	国道352号	1999	20	307.6	山口土木事務所	南会津町																					○	H28年度	Ⅲ	Ⅲ	Ⅲ	Ⅲ	Ⅲ	Ⅲ	Ⅲ	Ⅲ	うき・剥離	うき・剥離	うき・剥離	うき・剥離	ひび割れ	舗装の異常、ひびわれ			PC	
0658	小豆温泉第2スノーシェット	アノキオセダイ2スノーシェット	国道352号	1999	20	279.7	山口土木事務所	南会津町																					○	H28年度	Ⅲ	Ⅰ	Ⅲ	Ⅱ	Ⅲ	Ⅲ	Ⅰ	Ⅱ	Ⅱ	うき・剥離	ひび割れ	ひび割れ	ひび割れ	その他	舗装の異常、 変形・欠損			PC
0659	下大戸沢スノーシェット	シモオホザワスノーシェット	国道352号	1997	22	365	山口土木事務所	檜枝岐村																					○	H28年度	Ⅲ			Ⅲ	Ⅲ			Ⅲ		ひび割れ	うき・剥離			舗装の異常、 路面の凹凸			RC	
0660	高屋敷スノーシェット	タヤシキスノーシェット	国道352号	1996	23	593.2	山口土木事務所	檜枝岐村																					○	H28年度	Ⅲ	Ⅰ	Ⅱ	Ⅲ	Ⅰ	Ⅱ	Ⅲ	Ⅰ	Ⅱ	ひび割れ	ひび割れ	ひび割れ	うき・剥離		舗装の異常、 剥離			RC
0661	高屋敷第一スノーシェルター	タヤシキダイ1スノーシェルター	国道352号	1990	29	121.2	山口土木事務所	檜枝岐村																					○	H28年度	Ⅲ	Ⅱ	Ⅱ	Ⅲ	Ⅱ	Ⅲ	Ⅰ	Ⅲ	Ⅰ	腐食	腐食	その他	腐食	うき・剥離	うき・剥離			M

(5) 平成26年～平成30年点検結果(判定区分)

平成26年～平成30年の1巡目点検結果(判定区分)を図2-7に示す。

全体としては、判定区分Ⅳが0%、判定区分Ⅲが64%、判定区分Ⅱが34%、判定区分Ⅰが2%であり、建設年別では、不明箇所を除き、建設年が古いほど判定区分Ⅲが多い状況であった。

判定Ⅰ～Ⅳの割合



図 2-7 H26～H30 シェッド・シェルター点検結果

(6) 変状分析

平成26年～平成30年の1巡目点検結果より、点検対象172箇所において、判定区分Ⅲとなった箇所の変状原因および変状箇所について、整理した結果を図2-8に示す。

【変状原因】

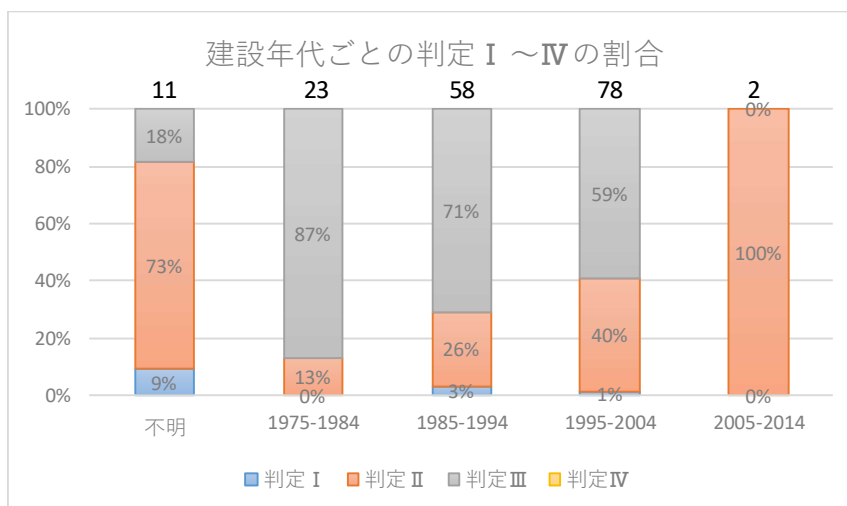
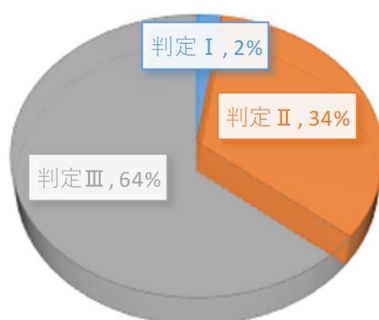
変状原因としては、うき・剥離、腐食、ひび割れ、漏水の順に多く、うき・剥離およびひび割れが全体の3/4を占めていた。要因としては、コンクリートの凍害や塩害の影響の他、乾燥収縮等の初期欠陥が考えられる。

腐食が原因の変状は全体の1/4であったが、鋼構造物のみで見ると、全52箇所のうち約6割の30箇所で腐食により判定区分Ⅲとなっていることから、鋼構造物についても劣化が進んでいる状況がわかる。劣化の要因としては、経年劣化や凍結防止剤による塩害等が考えられ、構造物全体で劣化が進んでいる箇所については早期の対策が必要である。

【変状箇所】

変状箇所としては、横梁、主梁等の上部構造が全体の3/4以上を占めており、とくに屋根部材周辺の劣化が多いことがわかる。同箇所は雪・雨・落石等からの影響を直接受けやすく、維持管理上これらの影響は避けられないことから、定期的な修繕が必要と考えられる。



図 2-8 県内シェッド・シェルターにおける変状要因の内訳

2-3 シェッド・シェルター維持管理上の課題

(1) 厳しい自然条件

福島県は東北地方の南端に位置し、県土面積の85%を積雪寒冷地域が占めている。冬季には、車両通行のために散布された融雪剤による塩害や、コンクリート骨材中水分の氷結膨張に起因する凍害により、鋼材やコンクリートが損傷を受け、劣化が進みやすい。

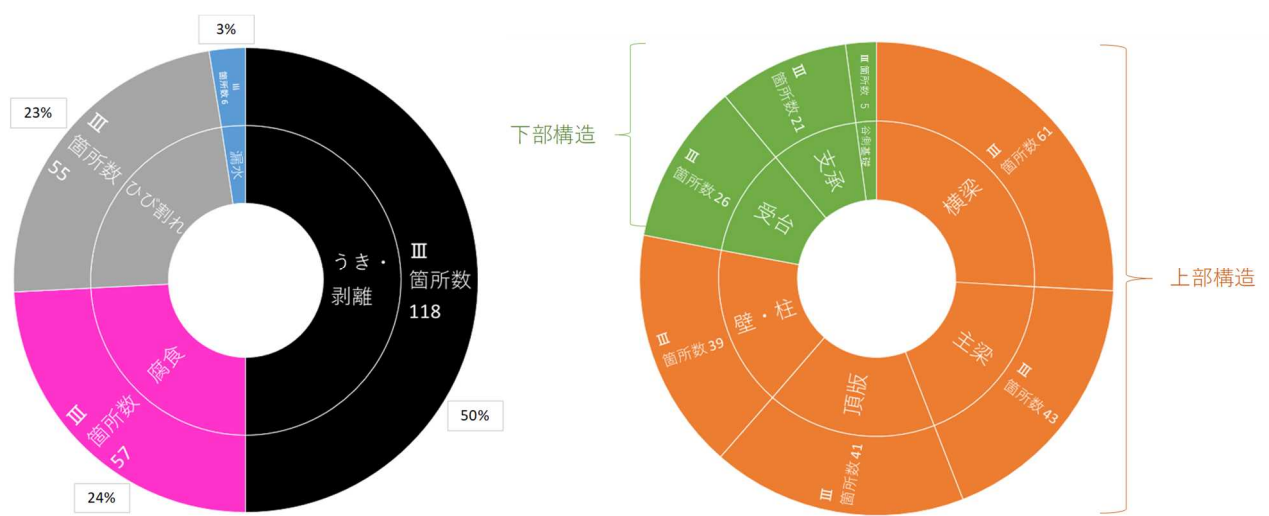

図 2-9 福島県内の積雪寒冷地域

(2) シェッド・シェルターの老朽化

平成 31 年 3 月現在、建設から 30 年を経過したシェッド・シェルターは 56 箇所あり、全体の 32%である。今後 10 年で、建設から 30 年を経過したシェッド・シェルターは 131 箇所(全体の 76%)に達するため、老朽化に伴い、修繕にかかる費用が増加する見込みである。

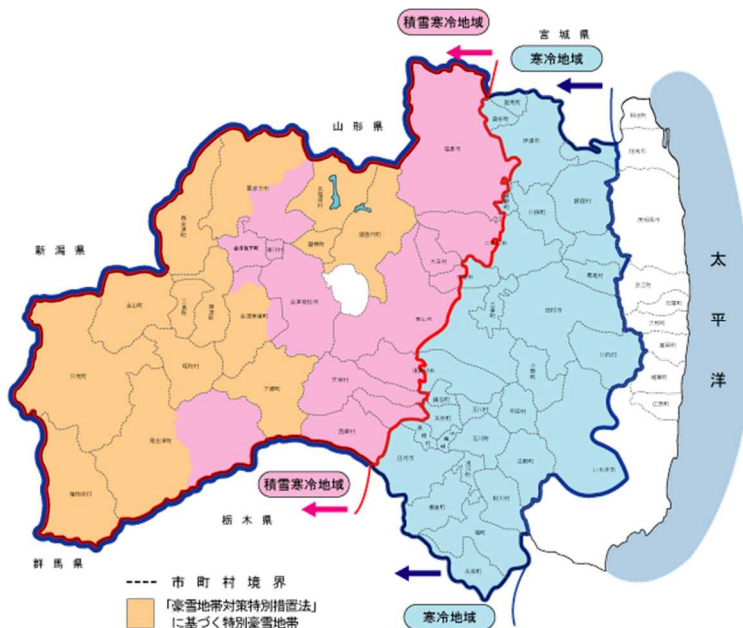

図 2-10 建設後 30 年以上経過したシェッド・シェルター数

第3章 シェッド・シェルター維持管理計画と個別施設計画

3-1 目標の整理と修繕方針

(1) 目標の整理

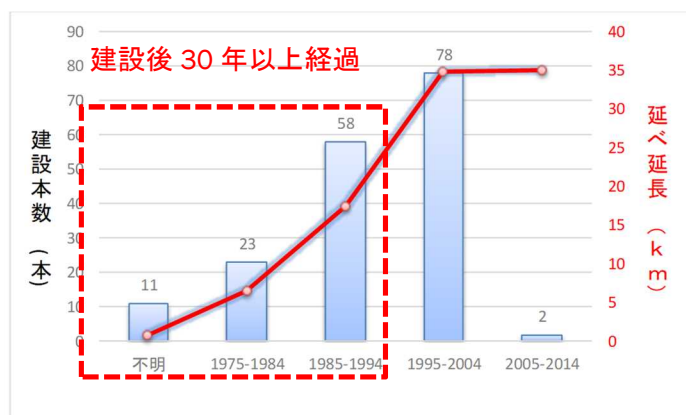
シェッド・シェルターを維持管理する上での目標は、道路利用者への被害を発生させず、快適な利用環境を継続することにある。このため、以下①～③の利用者被害を生じさせないことを目標とする。

- ① シェッド・シェルター本体の損傷の進行に伴う通行閉鎖を発生させない
- ② コンクリート片、つらら、付属物が落下することによる利用者被害を発生させない
- ③ 漏水・路面変状等に起因する利用者被害を発生させない

(2) 修繕方針

福島県のシェッド・シェルター維持管理においては、LCC の観点から「予防保全」を採用している。シェッド・シェルターは降雨や降雪により常に浸食作用を受けており、損傷状況によって補修工法・費用が異なることから、損傷の小さいうちに予防保全的な措置を行うことで、維持管理に係るトータルコストの最小化を図るものである(図 3-1)。



図 3-1 補修・補強・更新費用の累計

(平成 28 年福島県道路長寿命化計画より抜粋)

(3) 対策工法の整理

変状原因ごとの対策工法例を表 3-1 に示す。損傷度等を考慮して、工法を決定する。

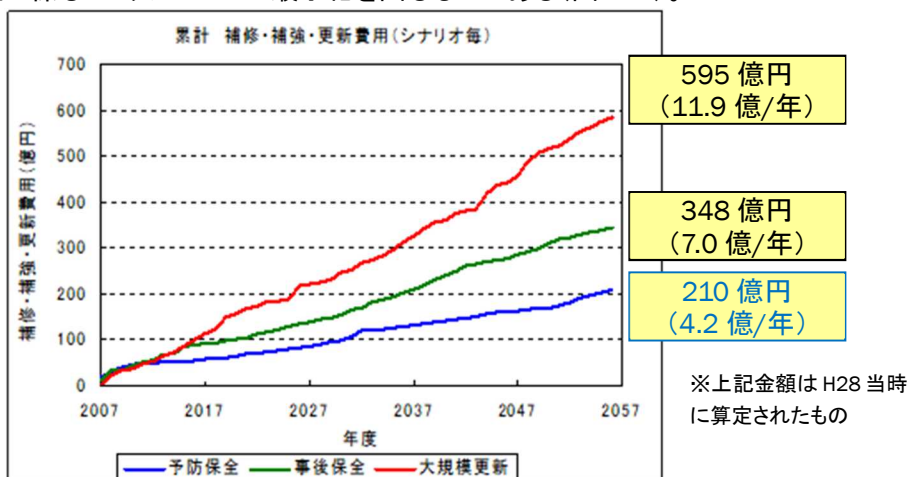
表 3-1 対策工法例

代表的な変状現象	対策工		損傷度
	対策工	損傷度	
ひび割れ	ひび割れ補修	表面被覆工・表面含浸工	小
		ひび割れ注工	中
うき、剥離	はつり落とし工		小
	断面補修工		↓
	剥落防止工(金網ネット工、当て板工等)		中
腐食	防食工	塗装工	小
		補修溶接工	↓
		当て板補強工	中
漏水、つらら	防水工		-
共通	部材交換工		大

3-2 補修優先度と補修サイクル

(1) 補修優先度

表 3-2 にシェッド・シェルター本体の補修優先度を示す。

シェッド・シェルターにおける対策の優先度は、点検の判定区分(Ⅳ～Ⅰ)によって決定し、同一判定区分内については緊急輸送路や重要物流道路などの路線重要度、交通量の大小等に基づき、優先度を決定する。

表 3-2 補修優先度(本体外)

判定区分	状態	対策の優先度		
		重要度：大 【グループA】	重要度：中 【グループB】	重要度：小 【グループC】
Ⅰ	健全	不要 (2箇所)	不要 (1箇所)	不要 (1箇所)
Ⅱ	予防保全段階	⑤予防保全 (23箇所)	⑥予防保全 (21箇所)	⑦予防保全 (14箇所)
Ⅲ	早期措置段階	②早期対策 (75箇所)	③早期対策 (26箇所)	④早期対策 (9箇所)
Ⅳ	緊急措置段階	①緊急対策 (0箇所)	①緊急対策 (0箇所)	①緊急対策 (0箇所)

1. 点検の判定区分
↓
2. 路線重要度
↓
3. 交通量

グループA:緊急輸送路、重要物流道路
グループB:補助国道、主要地方道、一般県道(交通量3,000台/日以上)
グループC:一般県道(交通量3,000台/日以下)
「早期対策」は、5年程度を想定

(2) 補修・更新サイクル

判定区分Ⅲ以上のシェッド・シェルター本体の補修については、次回の法点検(5年後)までに補修を行うことを基本とし、日常点検によって判定区分Ⅲ以上の箇所が新たに発見された場合においても、補修実施の対象とする。県内の判定区分Ⅲ箇所がすべて解消した後に、判定区分Ⅱの補修に着手するものとする。

なお、照明設備のLED化については、水銀灯の生産中止および維持管理費低減化のため、令和元年度から更新事業を進めているところである。

表 3-3 補修・更新サイクル

項目	補修・更新サイクル
シェッド・シェルター本体	法点検の判定区分Ⅲ以上の箇所について、5年後の次回点検までに補修を行う。 (または、日常点検により判定区分Ⅲ以上が発見された場合に補修を行う)

※補修範囲の考え方

判定区分Ⅲへの対策を基本とするが、判定区分Ⅲの近接箇所に判定区分Ⅱがあり、仮設等の関係から、同時施工がライフサイクルコスト面で効果的かつ効率的と考えられる場合においては、ⅢとⅡを合わせて実施することを可能とする。ただし、ⅢとⅡの箇所で工種が全く異なる場合にはこの限りでない。

3-3 シェッド・シェルターの個別施設計画（修繕計画）

（1）個別施設計画（修繕計画）

各シェッド・シェルターの修繕時期・修繕内容等について、個別施設計画（修繕計画）として表 3-4～表 3-8 に示す。

表 3-4 個別施設計画(1/5)

諸元	施設名		路線名	完成年度 (西暦)	2019現在 経過年数	延長(m)	管理事務所名	市区町村名	点検結果 判定区分	部材	修繕計画										優先順位				
	シェッド名	フリガナ									修繕計画(H26～H30点検結果に対する修繕計画)										修繕内容	緊急輸送 道路	重要物流 道路	H27交通 量	優先度 (A,B,C)
											H26	H27	H28	H29	H30	R1	R2	R3	R4	R5					
0101	角間下ロックシェッド	カマシロックシェッド	国道399号	1983	36	102	県北建設事務所	福島市	II	RC											ひび割れ補修	○	○	1,300	B
0201	三王坂スノーシェルター	サンノウサカスノーシェルター	国道294号	2002	17	148	県中建設事務所	郡山市	II	M											ひび割れ補修			3,816	B
0301	関岡ロックシェッド	セキオロックシェッド	国道118号	不明		39.5	棚倉土木事務所	矢祭町	II	M											防水工			4,858	B
0302	赤面スノーシェッド	アカツラスノーシェッド	一般県道那須甲子線	不明		10.2	県南建設事務所	西郷村	II	M											ひび割れ補修			792	C
0401	栃平スノーシェッド	トチダラスノーシェッド	国道121号	1993	26	76	喜多方建設事務所	喜多方市	III	PC						○	○				断面修復	○		2,731	A
0402	桜峠1号シェルター	サクラトウゲ1号シェルター	国道459号	1993	26	171.2	喜多方建設事務所	北塩原村	III	M							○	○			断面修復	○		2,332	A
0403	桜峠2号シェルター	サクラトウゲ2号シェルター	国道459号	1993	26	81.6	喜多方建設事務所	北塩原村	III	M							○	○			断面修復	○		2,332	A
0404	桜峠3号シェルター	サクラトウゲ3号シェルター	国道459号	1993	26	111.6	喜多方建設事務所	北塩原村	III	M								○	○		塗装工	○		2,332	A
0405	不動スノーシェッド	フドウスノーシェッド	国道459号	1987	32	308.1	喜多方建設事務所	喜多方市	III	PC							○	○			断面修復			708	B
0406	槻ノ木平スノーシェッド	ツキノキヒラズノーシェッド	国道459号	1995	24	152.4	喜多方建設事務所	喜多方市	III	PC							○	○			断面修復			708	B
0407	釜の脇スノーシェッド	カマノワキスノーシェッド	主要地方道喜多方・西会津線	1990	29	374.2	喜多方建設事務所	西会津町	III	PC							○	○			断面修復	○		1,575	A
0408	五万堂ロックシェッド	ゴマンドウロックシェッド	主要地方道猪苗代・湖南線	2001	18	754.9	猪苗代土木事務所	猪苗代町	II	PC											ひび割れ補修			1,892	B
0409	飯根スノーシェッド	イネスノーシェッド	一般県道熱塩加納・山都・西会津線	1989	30	112	喜多方建設事務所	西会津町	II	PC											ひび割れ補修			858	C
0410	宝坂スノーシェッド	ホウサカスノーシェッド	一般県道徳沢・宝坂線	1999	20	439.3	喜多方建設事務所	西会津町	III	PC							○	○			断面修復			314	C
0411	揚津スノーシェッド	アゲツスノーシェッド	一般県道新郷萩野(停)線	1992	27	118.6	喜多方建設事務所	喜多方市	III	PC							○	○			断面修復			396	C
0501	本名スノーシェッド①	ホンナスノーシェッド①	国道252号	1980	39	514	宮下土木事務所	金山町	III	M							○				塗装工	○		2,691	A
0502	本名スノーシェッド②	ホンナスノーシェッド②	国道252号	1980	39	92.9	宮下土木事務所	金山町	III	RC							○				塗装工	○		2,691	A
0503	本名スノーシェッド③	ホンナスノーシェッド③	国道252号	1980	39	179.3	宮下土木事務所	金山町	III	M							○				塗装工	○		2,691	A
0504	本名スノーシェッド④	ホンナスノーシェッド④	国道252号	1980	39	55.9	宮下土木事務所	金山町	III	RC							○				断面修復	○		2,691	A
0505	本名スノーシェッド⑤	ホンナスノーシェッド⑤	国道252号	1980	39	452	宮下土木事務所	金山町	III	M							○				塗装工	○		2,691	A
0506	本名第2スノーシェッド	ホンナダイ2スノーシェッド	国道252号	1983	36	131.1	宮下土木事務所	金山町	III	M							○				断面修復、塗装工	○		2,691	A
0507	水沼スノーシェッド	ミズヌマスノーシェッド	国道252号	1986	33	61.1	宮下土木事務所	金山町	III	M							○	○			修繕済み	○		2,691	A
0508	水沼第2スノーシェッド①	ミズヌマダイ2スノーシェッド①	国道252号	1981	38	99.8	宮下土木事務所	金山町	III	M								○			塗装工	○		2,691	A
0509	水沼第2スノーシェッド②	ミズヌマダイ2スノーシェッド②	国道252号	1981	38	194.6	宮下土木事務所	金山町	III	M								○			塗装工	○		2,691	A
0510	滝原スノーシェッド	タキハラスノーシェッド	国道252号	1984	35	141.4	宮下土木事務所	三島町	III	M							○				断面修復	○		2,691	A
0511	滝スノーシェッド	タキスノーシェッド	国道252号	1980	39	766.1	宮下土木事務所	金山町	III	M							○				塗装工	○		2,691	A
0512	滝第2スノーシェッド	タキダイ2スノーシェッド	国道252号	1992	27	199.7	宮下土木事務所	金山町	III	M							○				屋根材補修	○		2,691	A
0513	大深沢スノーシェッド	オオフサワスノーシェッド	国道252号	1981	38	541.3	宮下土木事務所	金山町	III	M							○				断面修復、塗装工	○		2,691	A
0514	下大牧第1スノーシェッド	シモオオマキダイ1スノーシェッド	国道252号	1985	34	242.3	宮下土木事務所	金山町	III	M							○	○			修繕済み	○		2,691	A
0515	駒啼瀬スノーシェルター	コマナカセスノーシェルター	国道252号	1989	30	333.5	宮下土木事務所	三島町	III	M							○				附属物修繕	○		4,426	A
0516	早戸第2兼用スノーシェッド	ハセダダイ2ケンヨウスノーシェッド	国道252号	1991	28	416.5	宮下土木事務所	三島町	III	PC							○				断面修復	○		2,691	A
0517	持寄第1スノーシェッド	モチヨリダイ1スノーシェッド	国道252号	1988	31	561.3	宮下土木事務所	柳津町	III	PC							○				断面修復	○		4,426	A
0518	持寄スノーシェルター	モチヨリスノーシェルター	国道252号	1991	28	167.7	宮下土木事務所	柳津町	I	M											-	○		4,426	A
0519	川井スノーシェルター	カワイスノーシェルター	国道252号	不明		97.6	宮下土木事務所	三島町	III	M							○				ボルト交換	○		4,426	A
0520	高清水スノーシェッド	タカシミズスノーシェッド	国道252号	1995	24	630.9	宮下土木事務所	三島町	III	PC							○				断面修復	○		2,691	A
0521	高清水第2スノーシェッド	タカシミズダイ2スノーシェッド	国道252号	2003	16	279.7	宮下土木事務所	三島町	III	PC							○				断面修復	○		2,691	A
0522	高倉スノーシェッド	タカクラスノーシェッド	国道252号	1986	33	83.8	宮下土木事務所	金山町	III	PC							○				断面修復	○		2,691	A
0523	名入スノーシェッド	ナイルスノーシェッド	国道252号	1999	20	354.6	宮下土木事務所	三島町	III	PC							○				断面修復	○		2,691	A
0524	松原第1スノーシェッド	ヒノハラダイ1スノーシェッド	国道252号	1995	24	513.8	宮下土木事務所	三島町	III	PC								○			断面修復	○		4,426	A
0525	松原スノーシェッド	ヒノハラスノーシェッド	国道252号	1995	24	368.5	宮下土木事務所	三島町	III	PC								○			断面修復	○		4,426	B
0526	松山スノーシェッド①	マツヤマスノーシェッド①	国道400号	1997	22	170.7	宮下土木事務所	昭和村	II	M											ひび割れ補修	○		519	A

表 3-5 個別施設計画(2/5)

Table with columns for facility name, route, completion year, length, management office, location, and repair schedule. Includes a detailed repair plan section with specific tasks and priority levels.

表 3-6 個別施設計画(3/5)

Table with columns for facility name, route, completion year, extension length, management office, and maintenance schedule. It includes a detailed table with 41 rows of facility data and a legend for priority levels (A, B, C).

表 3-7 個別施設計画 (4/5)

諸元	施設名		路線名	完成年度 (西暦)	2019現在 経過年数	延長(m)	管理事務所名	市区町村名	点検結果 判定区分	部材 RC PC M	修繕計画											優先順位							
	シェッド No	シェッド名									アカナ	修繕計画(H26~H30点検結果に対する修繕計画)											修繕内容	緊急輸送 道路	重要物流 道路	H27交通 量	優先度 (A,B,C)		
												H26	H27	H28	H29	H30	R1	R2	R3	R4	R5	A						B	C
												○ (設計着手時点で○とする)																○	
0642	杉沢スノーシェッド	スキヤウスノーシェッド	国道289号	1995	24	180	山口土木事務所	只見町	Ⅲ	PC									○			○			2,390	A			
0643	東スノーシェルター	アツマスノーシェルター	国道289号	2002	17	278	山口土木事務所	南会津町	Ⅲ	M									○			○			3,279	A			
0644	東2スノーシェルター	アツマスノーシェルター	国道289号	2010	9	90	山口土木事務所	南会津町	Ⅱ	M												○			3,279	A			
0645	東スノーシェッド	アツマスノーシェッド	国道289号	1991	28	210	山口土木事務所	南会津町	Ⅲ	PC									○			○			3,279	A			
0646	戸板山スノーシェルター	トイヤマスノーシェルター	国道289号	2000	19	360	山口土木事務所	南会津町	Ⅲ	M									○			○			3,279	A			
0647	下山ロックシェッド	シモヤマロックシェッド	国道289号	2000	19	378.8	山口土木事務所	南会津町	Ⅲ	PC									○			○			3,832	A			
0648	館ノ川スノーシェッド	タナカスノーシェッド	国道289号	1997	22	194.7	山口土木事務所	只見町	Ⅲ	PC												○			2,390	A			
0649	叶津スノーシェッド	カウツスノーシェッド	国道289号	1995	24	370	山口土木事務所	只見町	Ⅱ	RC															310	B			
0650	平石山スノーシェッド	ヒラシヤマスノーシェッド	国道289号	1996	23	104.3	山口土木事務所	只見町	Ⅱ	PC															310	B			
0651	梁取ロックシェッド	ヤマトロックシェッド	国道289号	1996	23	103.7	山口土木事務所	只見町	Ⅲ	PC									○			○			2,390	A			
0652	界ロックシェッド	サカイロックシェッド	国道289号	不明		150	山口土木事務所	南会津町	Ⅲ	PC												○			3,832	A			
0653	山口スノーシェッド	ヤマグチスノーシェッド	国道289号	1994	25	149.6	山口土木事務所	南会津町	Ⅲ	PC									○			○			3,279	A			
0654	鳴瀧スノーシェッド①	ナルタニスノーシェッド①	国道352号	1985	34	211	山口土木事務所	榎枝岐村	Ⅲ	PC									○	○					1,471	A			
0655	鳴瀧スノーシェッド②	ナルタニスノーシェッド②	国道352号	1985	34	375	山口土木事務所	榎枝岐村	Ⅲ	M									○			○			1,471	A			
0656	小立岩スノーシェッド	コダイイワスノーシェッド	国道352号	1975	44	122.7	山口土木事務所	南会津町	Ⅲ	PC									○	○					1,471	A			
0657	小豆温泉第1スノーシェッド	アヅキノセンダイ1スノーシェッド	国道352号	1999	20	307.6	山口土木事務所	南会津町	Ⅲ	PC									○	○					1,471	A			
0658	小豆温泉第2スノーシェッド	アヅキノセンダイ2スノーシェッド	国道352号	1999	20	279.7	山口土木事務所	南会津町	Ⅲ	PC									○	○					1,471	A			
0659	下大戸沢スノーシェッド	シモオトサウズノーシェッド	国道352号	1997	22	365	山口土木事務所	榎枝岐村	Ⅲ	RC									○						1,471	A			
0660	高屋敷スノーシェッド	タカヤシキスノーシェッド	国道352号	1996	23	593.2	山口土木事務所	榎枝岐村	Ⅲ	RC									○						1,471	A			
0661	高屋敷第一スノーシェルター	タカヤシキダイ1スノーシェルダー	国道352号	1990	29	121.2	山口土木事務所	榎枝岐村	Ⅲ	M												○			1,471	A			
0662	高屋敷第二スノーシェルター	タカヤシキダイ2スノーシェルダー	国道352号	1990	29	68.2	山口土木事務所	榎枝岐村	Ⅲ	M												○			1,471	A			
0663	数間沢ロックシェッド	カヌマサワロックシェッド	国道352号	2008	11	21	山口土木事務所	南会津町	Ⅱ	PC															2,059	A			
0664	数間沢第1スノーシェッド	カヌマサワダイ1スノーシェッド	国道352号	1991	28	450.2	山口土木事務所	南会津町	Ⅲ	PC									○						2,059	A			
0665	数間沢第2スノーシェッド	カヌマサウスノーシェッド	国道352号	1997	22	187.6	山口土木事務所	南会津町	Ⅲ	PC									○						1,471	A			
0666	耻風スノーシェッド	ハジカゼスノーシェッド	国道352号	1990	29	468	山口土木事務所	南会津町	Ⅲ	PC									○						2,059	A			
0667	上ノ山スノーシェッド	カミヤマスノーシェッド	国道352号	1979	40	180	山口土木事務所	南会津町	Ⅲ	PC									○						1,471	A			
0668	滝ノ原ロックシェッド	タキノハラロックシェッド	国道352号	1995	24	114	南会津建設事務所	南会津町	Ⅲ	PC												○			2,059	A			
0669	滝ノ原第2ロックシェッド	タキノハラダイニロックシェッド	国道352号	1999	20	111	南会津建設事務所	南会津町	Ⅲ	PC												○			2,059	A			
0670	新坂第1スノーシェッド	ニザカダイ1スノーシェッド	国道352号	1991	28	58.4	山口土木事務所	南会津町	Ⅱ	PC															2,059	A			
0671	新坂第2スノーシェッド	ニザカダイ2スノーシェッド	国道352号	1991	28	74.7	山口土木事務所	南会津町	Ⅱ	PC															2,059	A			
0672	深瀬スノーシェッド	フカセスノーシェッド	国道352号	1989	30	241.2	山口土木事務所	南会津町	Ⅲ	PC									○	○					1,471	A			
0673	駒ヶ岳スノーシェッド	コマカケスノーシェッド	国道352号	1992	27	468	山口土木事務所	南会津町	Ⅲ	PC									○	○					1,471	A			
0674	追分スノーシェッド	オイワクスノーシェッド	国道352号	1989	30	145.7	山口土木事務所	榎枝岐村	Ⅲ	PC												○			1,471	A			
0675	藤ヶ平スノーシェルター	フジガハイラスノーシェルダー	国道352号	2002	17	100	山口土木事務所	榎枝岐村	Ⅲ	M												○			1,471	A			
0676	八総スノーシェルター	ヤソウスノーシェルダー	国道352号	2003	16	130	山口土木事務所	南会津町	Ⅱ	M															2,059	A			
0677	鬼丸山スノーシェッド	キムヤマスノーシェッド	国道352号	1992	27	64.5	山口土木事務所	南会津町	Ⅲ	PC												○			2,059	A			
0678	平沢スノーシェッド	ヒラサウスノーシェッド	国道352号	1999	20	260.6	山口土木事務所	南会津町	Ⅲ	PC												○			1,471	A			
0679	浜野ロックシェッド	ハマノロックシェッド	国道401号	1994	25	180	山口土木事務所	南会津町	Ⅲ	PC												○			3,501	A			
0680	内川ロックシェッド	ウチカリロックシェッド	国道401号	2002	17	361	山口土木事務所	南会津町	Ⅲ	PC															3,501	A			
0681	六石山ロックシェッド	ロウシヨウヤマロックシェッド	一般県道下郷会津本郷線	不明		32	南会津建設事務所	下郷町	Ⅱ	RC															568	C			
0682	布沢スノーシェッド	フサウスノーシェッド	一般県道小林会津宮下(俣)線	1988	31	62.7	山口土木事務所	只見町	Ⅲ	PC												○			308	C			

表 3-8 個別施設計画(5/5)

諸元									点検結果	修繕計画										優先順位										
	施設名		路線名	完成年度 (西暦)	2019現在 経過年数	延長(m)	管理事務所名	市区町村名		判定区分	部材	修繕計画(H26~H30点検結果に対する修繕計画)										緊急輸送 道路	重要物流 道路	H27交通 量	優先度 (A,B,C)					
	シェッド名	フリガナ										H26	H27	H28	H29	H30	R1	R2	R3	R4	R5					修繕内容				
シェッド No								・I ・II ・III ・IV	RC PC M	○ (設計着手時点で○とする)										-	○	○	台/日	A(重要度:大)重要物流道 路または緊急輸送路 B(重要度:中)補助国道主 要地方道一般県道(交通 量3,000台/日以上) C(重要度:小)一般県道 (交通量3,000台/日以下)						
0683	篠輪スノーシェッド	シノラスノーシェット	一般県道小林会津宮下 (保)線	1998	21	186	山口土木事務所	只見町	III	PC												○				断面修復			308	C
0684	荒島ロックシェッド	アヲシマロックシェット	一般県道小林館川線	2003	16	90	山口土木事務所	只見町	III	PC																断面修復			701	C
0685	九々生ロックシェッド	ククジュウロックシェット	一般県道大倉大橋浜野 線	不明		91.7	山口土木事務所	只見町	II	M																ひび割れ補修			852	C
0686	和泉田スノーシェッド	イズミタスノーシェット	一般県道大倉大橋浜野 線	2001	18	95.8	山口土木事務所	南会津町	II	PC																ひび割れ補修			852	C
0687	蛇岩スノーロックシェッド	シヤイワスノーロックシェット	一般県道大倉大橋浜野 線	2003	16	81.9	山口土木事務所	南会津町	II	PC																ひび割れ補修			852	C
0688	小野岳ロックシェッド	オノダケロックシェット	一般県道湯野上会津高 田線	1983	36	60	南会津建設事務所	下郷町	III	PC																断面修復			2,337	C
0701	石淵ロックシェッド	イシフチスノーシェット	一般県道草野・大倉・鹿 島線	1983	36	36	相双建設事務所	南相馬市	III	PC																断面修復			1,573	C
0801	大沢ロックシェッド	オオサワロックシェット	主要地方道小野四倉線	1978	41	75.2	いわき建設事務所	いわき市	II	PC																ひび割れ補修			900	B

第4章 今後の方針

4-1 今後の点検・修繕の実施方針

(1) 今後の点検について

5年に一度の法点検のスケジュールに基づき、遅延無く点検を実施するとともに、予算の平準化のために点検スケジュールを見直していく。

(2) 今後の修繕について

判定区分Ⅳに診断された箇所については即時修繕対応とし、判定区分Ⅲの箇所については次回法点検までに修繕を実施、判定区分Ⅱについては判定区分Ⅲの修繕が完了した後の対応とする。

今後10年～20年については、建設から30年を経過するシェッド・シェルター数がピークに達すること、県内数カ所でも現在もシェッド・シェルターを建設中であり今後シェッド・シェルター数が増加することを踏まえ、今回試算した「今後5年間の必要事業費」以上の事業費が必要になることから、予算の確保および修繕・更新費用の抑制が引き続き重要である。

今後も図4-1に示すように点検・修繕を繰り返し、安全で快適なシェッド・シェルター利用環境の維持を図る必要がある。このため、令和元年～令和5年の2巡目法点検完了後には、本計画を見直し、修繕マネジメントを最適化していくものとする。



図 4-1 福島県長寿命化修繕計画の流れ

●お問い合わせ

福島県 土木部 道路管理課

〒960-8670 福島県福島市杉妻町 2-16

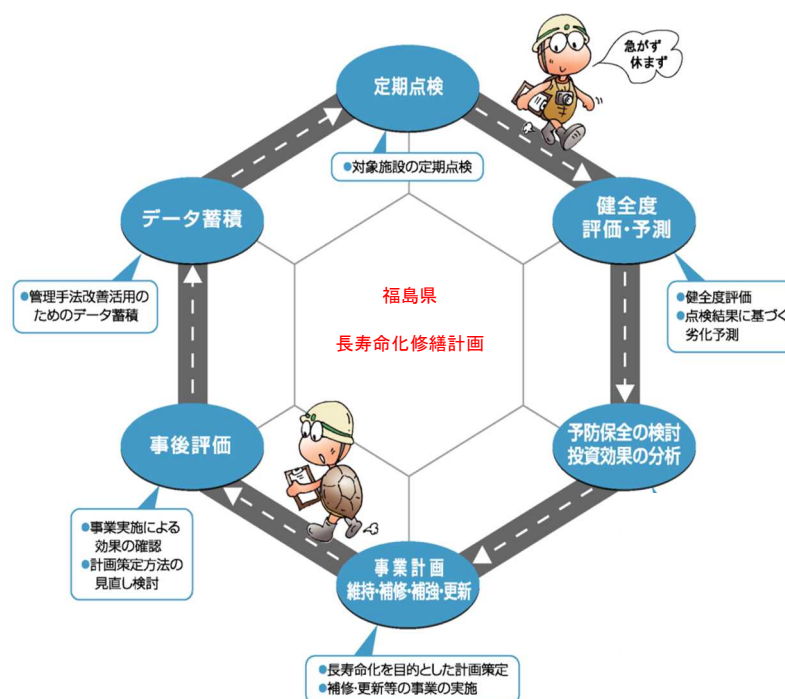
TEL. 024-521-7474 FAX. 024-521-7951

<http://www.pref.fukushima.lg.jp/sec/41035c/>
