

令和3年度

健康ふくしま21調査報告書

令和3年11月

令和3年度健康ふくしま21調査事務局
公立大学法人 福島県立医科大学 健康増進センター

目 次

第1章 調査の概要

1	調査の目的	1
2	調査規模（前回平成30年度と同規模）	1
3	主な調査方法	1
4	調査区選定方法	1
5	調査内容	2
	(1) 質問項目	2
	(2) 質問形式	2
6	調査実施時期	2
7	調査票等に関する秘密の保持	2
8	調査客体	3
	(1) 調査世帯数	3
	(2) 調査者数	3
	(3) 回答者年齢階級別状況	3
9	集計及び作表方法	4
10	留意点	4
	(1) 数 値	4
	(2) 集計表	4
11	調査票様式	5

第2章 令和3年度健康ふくしま21調査の結果（満15歳以上対象）

1	健康についての意識（調査票 問1）	13
2	健康づくりのために気をつけていること（調査票 問2）	17
3	「県民健康の日」の認知度（調査票 問3）	20
4	食生活（朝食）の状況（調査票 問4）	23
5	食生活（朝食・夕食）の状況（調査票 問5）	26
6	「食育推進月間」「食育の日」の認知度（調査票 問6）	34
7	食生活（栄養バランス）の状況（調査票 問7）	38
8	「フレイル」の認知度（調査票 問8）	41
9	「ロコモティブシンドローム」の認知度（調査票 問9）	44
10	最近1年間の運動状況（調査票 問10）	
	(1) 運動の状況	47
	(2) 運動時間（調査票 問10付問）	51
	(3) 運動習慣の状況（満20歳以上対象）	55
11	喫煙の状況	
	(1) 喫煙の有無（満20歳以上対象）（調査票 問11）	56
	(2) 禁煙の意思（満20歳以上対象）（調査票 問11付問）	60
	(3) 家族（世帯）の喫煙状況（調査票 問12）	64
13	受動喫煙の状況（調査票 問13）	65
14	「COPD（慢性閉塞性肺疾患）」の認知度（調査票 問14）	72
15	飲酒の状況（満20歳以上対象）（調査票 問15）	
	(1) 飲酒の頻度	75

(2) 飲酒の量（調査票 問15付問）	79
(3) 飲酒の状況	82
16 定期的な歯科健診の状況（調査票 問16）	84
17 歯みがきの状況（調査票 問17）	87
18 外出の状況（調査票 問18）	90
19 地域活動の実施状況（調査票 問19）	93
20 睡眠時間の状況（調査票 問20）	96
21 疲労の状況（調査票 問21）	100
22 健康づくりのために必要と考えること（調査票 問22）	104
23 自由回答（調査票 問23）	105

第3章 前回調査結果との比較（満15歳以上対象）	106
---------------------------------------	------------

第1章 調査の概要

1 調査の目的

本調査は、第二次健康ふくしま21計画の最終評価等を実施するに当たって、数値目標項目の現状の数値を把握するために行う。

2 調査規模（前回平成30年度と同規模）

- 対象者 約10,000人（15歳以上）住民基本台帳から世帯及び世帯員を抽出
約4,000世帯 世帯単位で調査を実施、県内の1世帯あたりの人数は、約2.39人（10,000人／2.39人＝約4,184世帯）

3 主な調査方法

平成27年国勢調査を基に、県内7地域で無作為抽出した調査区で、15歳以上の県民（男女）を対象に、郵送による自記式質問紙調査を行う。

※令和2年国勢調査の調査区は集計が終わっていないため使用不可。

4 調査区選定方法

住民基本台帳（令和2年1月1日現在）における7地域別の15歳以上の人口割合及び地域ごとの市（都市部）と町村（郡部）の人口比率を踏まえ、調査区を無作為抽出する。

【参考】 県内7方部の人口（令和2年1月1日現在） (人)

地域	A 人口	地域人口割合	B 市人口	市割合 (B/A)	C 町村人口	町村割合(C/A)
県北	411,951	24.8%	373,835	90.7%	38,116	9.3%
県中	421,964	25.4%	381,897	90.5%	40,067	9.5%
県南	158,776	9.6%	53,186	33.5%	105,590	66.5%
会津	210,879	12.7%	144,958	68.7%	65,921	31.3%
南会津	23,318	1.4%	0	0.0%	23,318	100.0%
相双	151,637	9.1%	84,608	55.8%	67,029	44.2%
いわき	283,840	17.1%	283,840	100.0%	0	0.0%
計	1,662,365	100.0%	1,322,324	79.5%	340,041	20.5%

※人口は住民基本台帳（令和2年1月1日現在）における15歳以上の人口

1万人換算した人口（令和2年1月1日現在）

（人）

地域	A 人口	地域別人口割合	B 市人口	市割合 (B/A)	C 町村人口	町村割合(C/A)
県北	2,478	24.8%	2,249	90.7%	229	9.2%
県中	2,539	25.4%	2,298	90.5%	241	9.5%
県南	955	9.6%	320	33.5%	635	66.5%
会津	1,269	12.7%	872	68.7%	397	31.3%
南会津	140	1.4%	0	0.0%	140	100.0%
相双	912	9.1%	509	55.8%	403	44.2%
いわき	1,707	17.1%	1,707	100.0%	0	0.0%
計	10,000	100.0%	7,955	79.6%	2,045	20.5%

※人口は住民基本台帳（令和2年1月1日現在）における15歳以上の人口

＜条件詳細＞

- ① 調査対象者数は、15歳以上の県民（男女）約1万人とし、7地域別の人口割合に応じて各地域別に調査区を無作為で抽出する。
- ② 抽出された調査区の15歳以上の県民を全て対象とする。
- ③ 平成27年国勢調査の調査区を基にした抽出ができない相双地域の町村は、調査地区を選定せず、町村ごとの年代別人口の割合を考慮した上で、調査対象者を無作為に抽出する。なお、その場合において、当該町村内外の居住の有無は問わず、当該町村に住民票を有し、県内に居住している者を対象とする

5 調査内容

- (1) 質問項目 比較を可能とするため、平成30年度に実施した健康ふくしま21調査の質問項目をベースとし、その他、現状を踏まえ質問を加除修正する。
- (2) 質問形式 該当番号を選択することを基本とするが、自由記述も数項目含む。

6 調査実施時期

令和3年6月から令和3年11月まで（名簿作成、督促、集計等の実施時期も含む）

7 調査票等に関する秘密の保持

本調査は、健康や生活習慣等について、具体的な情報を取り扱うことから、対象者に係る情報を適切に取り扱い、その個人情報保護するものとする。

特に、調査を委託して実施することから、受託者へ対し、個人情報の取り扱いに関しては適正な管理と厳重な秘密の保持を求めるものとする。

8 調査客体

県内約14,000の平成27年国勢調査の調査区から選定した107調査区に在住する県民

(1) 調査世帯数

	対象世帯数	回答世帯数	回答率	備 考
県 北	1,270	748	58.9%	26調査区（福島市、本宮市、国見町、大玉村）
県 中	1,158	658	56.8%	27調査区（郡山市、須賀川市、天栄村、平田村、三春町、小野町）
県 南	367	247	67.3%	11調査区（白河市、西郷村、泉崎村、矢祭町、鮫川村）
会 津	598	353	59.0%	14調査区（会津若松市、喜多方市、北塩原村、西会津町、会津坂下町、柳津町）
南会津	70	47	67.1%	3調査区（南会津町、下郷町）
相 双	412	174	42.2%	9調査区（相馬市、南相馬市、川内村、浪江町、大熊町）
いわき	849	453	53.4%	15調査区（いわき市）
総 数	4,724	2,680	56.7%	(105調査区)

(2) 調査者数

	対象者数	回答者数	回答率	回答者男女別		備 考
				男	女	
県 北	2,869	1,524	53.1%	732	792	
県 中	2,632	1,343	51.0%	657	686	
県 南	947	559	59.0%	273	286	
会 津	1,341	730	54.4%	351	379	
南会津	146	99	67.8%	52	47	
相 双	959	319	33.3%	160	159	
いわき	1,834	893	48.7%	431	462	
総 数	10,728	5,467	51.0%	2,656	2,811	

(3) 回答者年齢階級別状況

年齢階級	総 数	男	女	備 考
15～19歳	243	119	124	
20～29歳	345	166	179	
30～39歳	497	251	246	
40～49歳	714	374	340	
50～59歳	833	392	441	
60～64歳	523	263	260	
65～69歳	591	285	306	
70～79歳	1,006	497	509	
80～89歳	594	271	323	
90歳～	121	38	83	
合 計	5,467	2,656	2,811	

9 集計及び作表方法

集計にあたっては、被調査世帯から記入後の調査票の返送を受けた後、計算ソフト「エクセル」を利用してデータを入力、集計し、作表を行った。

10 留意点

(1) 数 値

- %値：基数を100%とし、グラフや表では小数第2位を四捨五入して小数第1位までを表示している。
(注意) 四捨五入の関係で、個々を合計した%値と合わないことがある。
- 0.0：%値が0または、0.05に満たなかったもの。

(2) 集 計 表

集計表については、県全体の集計結果及び各地域別の集計結果を、調査票の設問順に掲載している（一部を除く）。

- 集計表においては、各年代ごとに、その人数及び割合（%）を記載

市町村名
地区番号

令和3年度健康ふくしま21調査

1 この調査票は、満15歳以上(令和3年4月1日現在)の方が記入してください。

2 性別と年齢を必ず記入願います。(氏名の記入は必要ありません。)

性 別 (あてはまる番号に○)

年 齢 歳 (令和3年4月1日現在の年齢)

3 回答の仕方は、あてはまる番号に○をつけるものと、必要なことがらを書き込むものがあります。

4 都合によりご自分で記入できない方は、代理の方に記入していただくようお願いいたします。

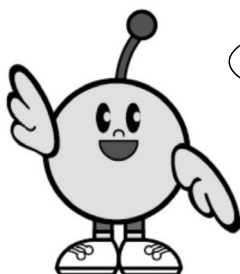

ご協力よろしくお願いします。

福島県

令和3年度健康ふくしま21調査 事務局
公立大学法人福島県立医科大学 健康増進センター
お問い合わせ先：024-547-1788
(月～金 9時～17時まで) ※祝日は除く

問6 あなたは、食育推進月間（6月）と食育の日（毎月19日）を知っていますか。
（あてはまる番号1つに○）

- 1 知っている
- 2 名称は知っているが、月日までは知らない
- 3 知らない

問7 あなたは、日頃から栄養バランスのとれた食生活を実践していますか。

- 1 はい
- 2 いいえ

【身体活動・運動について】

問8 あなたは、フレイルを知っていますか。

- 1 知っている
- 2 知らない

フレイル

健康な状態から、加齢によって、体や心のはたらき、社会とのつながりが弱くなった状態を言います。適切な治療や予防を行うことで要介護状態に進まないよう改善できる可能性があります。

問9 あなたは、ロコモティブシンドローム（運動器症候群）を知っていますか。

- 1 知っている
- 2 知らない

ロコモティブシンドローム（運動器症候群）

骨や関節、筋肉などの運動器のおとろえや障がいで介護を必要とする状態、または必要となる可能性の高い状態を言います。

問10 最近1年間の運動について、あてはまるものを1つ選んで○をつけてください。

- 1 何らかの運動をほとんど毎日している。（付問へ）
- 2 何らかの運動を週2～4回程度している。（付問へ）
- 3 何らかの運動を週1回程度している。（付問へ）
- 4 ほとんど（まったく）していない。

付問 問10で1～3を選んだ方におたずねします。1回の運動時間はどれくらいですか。複数の運動をしている方は、もっとも運動時間の長いものについてお答えください。

- 1 15分未満
- 2 15～30分未満
- 3 30分以上

問14 あなたは、「COPD（慢性閉塞性肺疾患）」という病気を知っていますか。

- 1 知っている 2 知らない

COPD（慢性閉塞性肺疾患）
空気の通り道である肺の気管支や酸素を取り込む肺胞で炎症が続き、気管支が狭くなったり、肺胞の壁が壊れる病気です。この病気にかかると、肺の機能が低下して十分な酸素を取り込めなくなり、息切れや、せき・たんが多く出たりします。原因の90%はたばこによるもので、喫煙者の20%が発症するとされています。

【飲酒について】

問15 あなたは、どのくらいお酒を飲んでいますか。（あてはまる番号1つに○）

- 1 毎日飲んでいる（付問へ） 2 週に5～6回飲んでいる（付問へ）
3 週に3～4回飲んでいる（付問へ） 4 たまに飲む程度（付問へ）
5 以前は飲んでいたが、今は飲んでいない 6 もともと飲まない

付問 問15で1～4を選んだ方におたずねします。あなたが1回に飲む量はどれくらいですか。日本酒にあてはめて計算し、あてはまる番号を1つ選んで○をつけてください。（計算の仕方は、下記のとおりです。）

- 1 極少量 2 1合程度
3 2合程度 4 3合以上

焼酎（25度、100ml）は・・・・・・・・・・日本酒約1合に当たる。
ビール中瓶1本（500ml）は・・・・・・・・・・日本酒約1合に当たる。
ウィスキーダブル1杯（60ml）は・・・・・・・・・・日本酒約1合に当たる。
ワイングラス2杯（200ml）は・・・・・・・・・・日本酒約1合に当たる。
うすめて飲むときは、もとの量で計算してください。

【歯・口腔の健康について】

問16 あなたは、定期的に歯科健診（歯石の除去、歯面清掃を含む）を受けていますか。

- 1 はい 2 いいえ

問17 あなたは、毎食後（1日3回以上）歯をみがいていますか。

- 1 はい 2 いいえ

問23 全体をとおして気付かれた点について、御自由にお書きください。

[]

記入して下さったのはどなたですか。

1 本人 2 代理人（続柄を教えてください。 ）

以上で終了です。お忙しいところ、御協力ありがとうございました。
この調査票は、同封の返信用封筒（切手不要）に入れて、9月10日（金）
までにポストに投かんしてください。



アンケートへのご協力
ありがとうございました。

第2章 令和3年度健康ふくしま21調査の結果 (満15歳以上対象)

【表の見方】(参考例)

「1と回答」した男性の数(人)を示す。【48人】

40:40~49歳を示す。詳しくは下記(1)を参照。

70代の男性の総数497人のうち、「1と回答」した70代の男性25人の総数に占める割合を示す。【25人/497人=5.0%】

	10	割合	20	割合	30	割合	40	割合	50	割合	64	割合	69	割合	70	割合	80	割合	90	割合	全体数	割合		
1と回答																								
男性	48	40.3%	36	21.7%	31	12.4%	29	7.8%	18	4.6%	14	5.3%	17	6.0%	25	5.0%	13	4.8%	7	18.4%			238	9.0%
女性	40	32.3%	27	15.1%	23	9.3%	30	8.8%	30	6.8%	16	6.2%	22	7.2%	29	5.7%	14	4.3%	7	8.4%			238	8.5%
男女合計	88	36.2%	63	18.3%	54	10.9%	59	8.3%	48	5.8%	30	5.7%	39	6.6%	54	5.4%	27	4.5%	14	11.6%			476	8.7%
2と回答																								
男性	61	51.3%	98	59.0%	168	66.9%	247	66.0%	283	72.2%	177	67.3%	198	69.5%	332	66.8%	170	62.7%	16	42.1%			1750	65.9%
女性	76	61.3%	117	65.4%	180	73.2%	245	72.1%	326	73.9%	194	74.6%	227	74.2%	346	68.0%	184	57.0%	41	49.4%			1936	68.9%
男女合計	137	56.4%	215	62.3%	348	70.0%	492	68.9%	609	73.1%	371	70.9%	425	71.9%	678	67.4%	354	59.6%	57	47.1%			3686	67.4%
3と回答																								
男性	7	5.9%	23	13.9%	42	16.7%	82	21.9%	68	17.3%	47	17.9%	53	18.6%	99	19.9%	53	19.6%	10	26.3%			484	18.2%
女性	6	4.8%	30	16.8%	33	13.4%	55	16.2%	69	15.6%	39	15.0%	44	14.4%	91	17.9%	71	22.0%	15	18.1%			453	16.1%
男女合計	13	5.3%	53	15.4%	75	15.1%	137	19.2%	137	16.4%	86	16.4%	97	16.4%	190	18.9%	124	20.9%	25	20.7%			937	17.1%
4と回答																								
男性	0	0.0%	7	4.2%	10	4.0%	15	4.0%	23	5.9%	20	7.6%	17	6.0%	34	6.8%	33	12.2%	4	10.5%			163	6.1%
女性	1	0.8%	5	2.8%	9	3.7%	8	2.4%	15	3.4%	10	3.8%	11	3.6%	39	7.7%	46	14.2%	18	21.7%			162	5.8%
男女合計	1	0.4%	12	3.5%	19	3.8%	23	3.2%	38	4.6%	30	5.7%	28	4.7%	73	7.3%	79	13.3%	22	18.2%			325	5.9%
無回答																								
男性	3	2.5%	2	1.2%	0	0.0%	1	0.3%	0	0.0%	5	1.9%	0	0.0%	7	1.4%	2	0.7%	1	2.6%			21	0.8%
女性	1	0.8%	0	0.0%	1	0.4%	2	0.6%	1	0.2%	1	0.4%	2	0.7%	4	0.8%	8	2.5%	2	2.4%			22	0.8%
男女合計	4	1.6%	2	0.6%	1	0.2%	3	0.4%	1	0.1%	6	1.1%	2	0.3%	11	1.1%	10	1.7%	3	2.5%			43	0.8%
全体(人)																								
男性	119		166		251		374		392		263		285		497		271		38				2656	
女性	124		179		246		340		441		260		306		509		323		83				2811	
男女合計	243		345		497		714		833		523		591		1006		594		121				5467	

- (1) 年齢の表示 10：15～19歳 (10代) 20：20～29歳 (20代)
 30：30～39歳 (30代) 40：40～49歳 (40代)
 50：50～59歳 (50代) 64：60～64歳 (60代前半)
 69：65～69歳 (60代後半) 70：70～79歳 (70代)
 80：80～89歳 (80代) 90：90～99歳 (90代)
- (2) 割合 それぞれの年代においてその回答に占める男性、女性又は男女合計数の割合 (%) を表示
- (3) 数値 ●%値：基数を100%とし、グラフや数表では少数第2位を四捨五入して少数第1位までを表示している。
 (注意) 四捨五入の関係で個々を合計した%値と合わないことがある。
 ●0.0：%値が0または0.05に満たなかったもの

*各地域別の集計表においては、各年代の欄に直接、割合(%)を記載している。

1 健康についての意識（調査票 問1）

問1 あなたは、ふだん自分で健康だと思えますか。（あてはまる番号1つに○）

- 1 非常に健康だと思ふ 2 まあ健康な方だと思ふ
- 3 あまり健康ではない 4 健康ではない

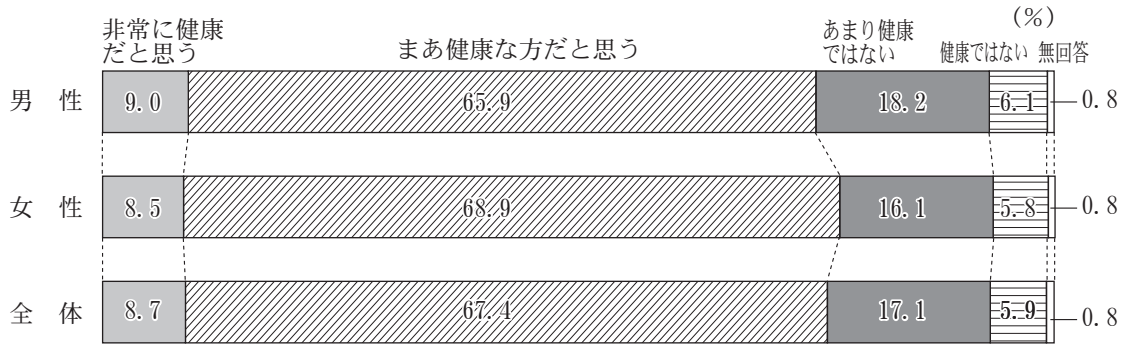

	10	割合	20	割合	30	割合	40	割合	50	割合	64	割合	69	割合	70	割合	80	割合	90	割合	全体数	割合
1と回答																						
男性	48	40.3%	36	21.7%	31	12.4%	29	7.8%	18	4.6%	14	5.3%	17	6.0%	25	5.0%	13	4.8%	7	18.4%	238	9.0%
女性	40	32.3%	27	15.1%	23	9.3%	30	8.8%	30	6.8%	16	6.2%	22	7.2%	29	5.7%	14	4.3%	7	8.4%	238	8.5%
男女合計	88	36.2%	63	18.3%	54	10.9%	59	8.3%	48	5.8%	30	5.7%	39	6.6%	54	5.4%	27	4.5%	14	11.6%	476	8.7%
2と回答																						
男性	61	51.3%	98	59.0%	168	66.9%	247	66.0%	283	72.2%	177	67.3%	198	69.5%	332	66.8%	170	62.7%	16	42.1%	1750	65.9%
女性	76	61.3%	117	65.4%	180	73.2%	245	72.1%	326	73.9%	194	74.6%	227	74.2%	346	68.0%	184	57.0%	41	49.4%	1936	68.9%
男女合計	137	56.4%	215	62.3%	348	70.0%	492	68.9%	609	73.1%	371	70.9%	425	71.9%	678	67.4%	354	59.6%	57	47.1%	3686	67.4%
3と回答																						
男性	7	5.9%	23	13.9%	42	16.7%	82	21.9%	68	17.3%	47	17.9%	53	18.6%	99	19.9%	53	19.6%	10	26.3%	484	18.2%
女性	6	4.8%	30	16.8%	33	13.4%	55	16.2%	69	15.6%	39	15.0%	44	14.4%	91	17.9%	71	22.0%	15	18.1%	453	16.1%
男女合計	13	5.3%	53	15.4%	75	15.1%	137	19.2%	137	16.4%	86	16.4%	97	16.4%	190	18.9%	124	20.9%	25	20.7%	937	17.1%
4と回答																						
男性	0	0.0%	7	4.2%	10	4.0%	15	4.0%	23	5.9%	20	7.6%	17	6.0%	34	6.8%	33	12.2%	4	10.5%	163	6.1%
女性	1	0.8%	5	2.8%	9	3.7%	8	2.4%	15	3.4%	10	3.8%	11	3.6%	39	7.7%	46	14.2%	18	21.7%	162	5.8%
男女合計	1	0.4%	12	3.5%	19	3.8%	23	3.2%	38	4.6%	30	5.7%	28	4.7%	73	7.3%	79	13.3%	22	18.2%	325	5.9%
無回答																						
男性	3	2.5%	2	1.2%	0	0.0%	1	0.3%	0	0.0%	5	1.9%	0	0.0%	7	1.4%	2	0.7%	1	2.6%	21	0.8%
女性	1	0.8%	0	0.0%	1	0.4%	2	0.6%	1	0.2%	1	0.4%	2	0.7%	4	0.8%	8	2.5%	2	2.4%	22	0.8%
男女合計	4	1.6%	2	0.6%	1	0.2%	3	0.4%	1	0.1%	6	1.1%	2	0.3%	11	1.1%	10	1.7%	3	2.5%	43	0.8%
全体(人)																						
男性	119		166		251		374		392		263		285		497		271		38		2656	
女性	124		179		246		340		441		260		306		509		323		83		2811	
男女合計	243		345		497		714		833		523		591		1006		594		121		5467	

県 北

	10	割合	20	割合	30	割合	40	割合	50	割合	64	割合	69	割合	70～	割合	全体数	割合
1と回答																		
男性	13	37.1%	9	18.8%	13	14.1%	11	8.6%	4	3.4%	3	4.8%	4	6.8%	10	5.3%	67	9.2%
女性	13	35.1%	4	7.8%	6	6.8%	10	9.7%	10	7.4%	3	4.8%	9	11.0%	11	4.7%	66	8.3%
男女合計	26	36.1%	13	13.1%	19	10.6%	21	9.1%	14	5.5%	6	4.8%	13	9.2%	21	5.0%	133	8.7%
2と回答																		
男性	19	54.3%	34	70.8%	58	63.0%	83	64.8%	84	71.2%	48	77.4%	44	74.6%	111	58.4%	481	65.7%
女性	23	62.2%	34	66.7%	68	77.3%	71	68.9%	98	72.6%	50	79.4%	61	74.4%	144	61.8%	549	69.3%
男女合計	42	58.3%	68	68.7%	126	70.0%	154	66.7%	182	71.9%	98	78.4%	105	74.5%	255	60.3%	1030	67.6%
3と回答																		
男性	3	8.6%	4	8.3%	16	17.4%	28	21.9%	25	21.2%	7	11.3%	8	13.6%	45	23.7%	136	18.6%
女性	1	2.7%	11	21.6%	11	12.5%	20	19.4%	23	17.0%	6	9.5%	8	9.8%	37	15.9%	117	14.8%
男女合計	4	5.6%	15	15.2%	27	15.0%	48	20.8%	48	19.0%	13	10.4%	16	11.3%	82	19.4%	253	16.6%
4と回答																		
男性	0	0.0%	0	0.0%	5	5.4%	5	3.9%	5	4.2%	3	4.8%	3	5.1%	22	11.6%	43	5.9%
女性	0	0.0%	2	3.9%	3	3.4%	1	1.0%	4	3.0%	3	4.8%	3	3.7%	38	16.3%	54	6.8%
男女合計	0	0.0%	2	2.0%	8	4.4%	6	2.6%	9	3.6%	6	4.8%	6	4.3%	60	14.2%	97	6.4%
無回答																		
男性	0	0.0%	1	2.1%	0	0.0%	1	0.8%	0	0.0%	1	1.6%	0	0.0%	2	1.1%	5	0.7%
女性	0	0.0%	0	0.0%	0	0.0%	1	1.0%	0	0.0%	1	1.6%	1	1.2%	3	1.3%	6	0.8%
男女合計	0	0.0%	1	1.0%	0	0.0%	2	0.9%	0	0.0%	2	1.6%	1	0.7%	5	1.2%	11	0.7%
全体(人)																		
男性	35		48		92		128		118		62		59		190		732	
女性	37		51		88		103		135		63		82		233		792	
男女合計	72		99		180		231		253		125		141		423		1524	

県 中

	10	割合	20	割合	30	割合	40	割合	50	割合	64	割合	69	割合	70～	割合	全体数	割合
1と回答																		
男性	15	45.5%	9	23.1%	5	10.4%	8	8.8%	6	5.5%	3	4.8%	7	9.1%	13	6.6%	66	10.0%
女性	7	24.1%	11	21.6%	8	14.3%	5	5.6%	3	2.9%	4	6.9%	4	5.9%	17	7.4%	59	8.6%
男女合計	22	35.5%	20	22.2%	13	12.5%	13	7.2%	9	4.2%	7	5.8%	11	7.6%	30	7.0%	125	9.3%
2と回答																		
男性	14	42.4%	22	56.4%	36	75.0%	56	61.5%	79	72.5%	38	60.3%	51	66.2%	121	61.4%	417	63.5%
女性	19	65.5%	35	68.6%	41	73.2%	72	80.0%	84	80.8%	38	65.5%	54	79.4%	140	60.9%	483	70.4%
男女合計	33	53.2%	57	63.3%	77	74.0%	128	70.7%	163	76.5%	76	62.8%	105	72.4%	261	61.1%	900	67.0%
3と回答																		
男性	2	6.1%	7	17.9%	5	10.4%	21	23.1%	19	17.4%	11	17.5%	13	16.9%	45	22.8%	123	18.7%
女性	1	3.4%	5	9.8%	3	5.4%	11	12.2%	14	13.5%	13	22.4%	7	10.3%	45	19.6%	99	14.4%
男女合計	3	4.8%	12	13.3%	8	7.7%	32	17.7%	33	15.5%	24	19.8%	20	13.8%	90	21.1%	222	16.5%
4と回答																		
男性	0	0.0%	1	2.6%	2	4.2%	6	6.6%	5	4.6%	9	14.3%	6	7.8%	15	7.6%	44	6.7%
女性	1	3.4%	0	0.0%	3	5.4%	2	2.2%	3	2.9%	3	5.2%	3	4.4%	23	10.0%	38	5.5%
男女合計	1	1.6%	1	1.1%	5	4.8%	8	4.4%	8	3.8%	12	9.9%	9	6.2%	38	8.9%	82	6.1%
無回答																		
男性	2	6.1%	0	0.0%	0	0.0%	0	0.0%	0	0.0%	2	3.2%	0	0.0%	3	1.5%	7	1.1%
女性	1	3.4%	0	0.0%	1	1.8%	0	0.0%	0	0.0%	0	0.0%	0	0.0%	5	2.2%	7	1.0%
男女合計	3	4.8%	0	0.0%	1	1.0%	0	0.0%	0	0.0%	2	1.7%	0	0.0%	8	1.9%	14	1.0%
全体(人)																		
男性	33		39		48		91		109		63		77		197		657	
女性	29		51		56		90		104		58		68		230		686	
男女合計	62		90		104		181		213		121		145		427		1343	

県 南

	10	割合	20	割合	30	割合	40	割合	50	割合	64	割合	69	割合	70～	割合	全体数	割合
1と回答																		
男性	3	42.9%	7	30.4%	2	9.1%	3	8.1%	2	5.9%	2	6.3%	0	0.0%	11	12.9%	30	11.0%
女性	7	36.8%	2	11.8%	2	11.1%	2	7.1%	2	4.3%	2	6.3%	0	0.0%	6	6.2%	23	8.0%
男女合計	10	38.5%	9	22.5%	4	10.0%	5	7.7%	4	5.0%	4	6.3%	0	0.0%	17	9.3%	53	9.5%
2と回答																		
男性	4	57.1%	13	56.5%	14	63.6%	21	56.8%	24	70.6%	20	62.5%	24	72.7%	55	64.7%	175	64.1%
女性	11	57.9%	11	64.7%	12	66.7%	19	67.9%	36	78.3%	24	75.0%	21	72.4%	59	60.8%	193	67.5%
男女合計	15	57.7%	24	60.0%	26	65.0%	40	61.5%	60	75.0%	44	68.8%	45	72.6%	114	62.6%	368	65.8%
3と回答																		
男性	0	0.0%	1	4.3%	6	27.3%	11	29.7%	5	14.7%	8	25.0%	6	18.2%	16	18.8%	53	19.4%
女性	1	5.3%	4	23.5%	4	22.2%	6	21.4%	5	10.9%	6	18.8%	5	17.2%	20	20.6%	51	17.8%
男女合計	1	3.8%	5	12.5%	10	25.0%	17	26.2%	10	12.5%	14	21.9%	11	17.7%	36	19.8%	104	18.6%
4と回答																		
男性	0	0.0%	1	4.3%	0	0.0%	2	5.4%	3	8.8%	1	3.1%	3	9.1%	3	3.5%	13	4.8%
女性	0	0.0%	0	0.0%	0	0.0%	1	3.6%	3	6.5%	0	0.0%	3	10.3%	12	12.4%	19	6.6%
男女合計	0	0.0%	1	2.5%	0	0.0%	3	4.6%	6	7.5%	1	1.6%	6	9.7%	15	8.2%	32	5.7%
無回答																		
男性	0	0.0%	1	4.3%	0	0.0%	0	0.0%	0	0.0%	1	3.1%	0	0.0%	0	0.0%	2	0.7%
女性	0	0.0%	0	0.0%	0	0.0%	0	0.0%	0	0.0%	0	0.0%	0	0.0%	0	0.0%	0	0.0%
男女合計	0	0.0%	1	2.5%	0	0.0%	0	0.0%	0	0.0%	1	1.6%	0	0.0%	0	0.0%	2	0.4%
全体(人)																		
男性	7		23		22		37		34		32		33		85		273	
女性	19		17		18		28		46		32		29		97		286	
男女合計	26		40		40		65		80		64		62		182		559	

会 津

	10	割合	20	割合	30	割合	40	割合	50	割合	64	割合	69	割合	70～	割合	全体数	割合
1と回答																		
男性	6	30.0%	6	21.4%	2	6.9%	3	8.8%	2	4.3%	2	4.0%	2	4.4%	3	3.1%	26	7.4%
女性	3	21.4%	5	23.8%	3	9.4%	3	8.8%	10	13.9%	3	7.0%	4	8.3%	7	6.1%	38	10.0%
男女合計	9	26.5%	11	22.4%	5	8.2%	6	8.8%	12	10.1%	5	5.4%	6	6.5%	10	4.7%	64	8.8%
2と回答																		
男性	13	65.0%	13	46.4%	20	69.0%	25	73.5%	38	80.9%	35	70.0%	31	68.9%	63	64.3%	238	67.8%
女性	9	64.3%	13	61.9%	21	65.6%	26	76.5%	52	72.2%	33	76.7%	37	77.1%	67	58.3%	258	68.1%
男女合計	22	64.7%	26	53.1%	41	67.2%	51	75.0%	90	75.6%	68	73.1%	68	73.1%	130	61.0%	496	67.9%
3と回答																		
男性	1	5.0%	5	17.9%	6	20.7%	6	17.6%	7	14.9%	9	18.0%	11	24.4%	17	17.3%	62	17.7%
女性	2	14.3%	2	9.5%	7	21.9%	3	8.8%	8	11.1%	7	16.3%	6	12.5%	25	21.7%	60	15.8%
男女合計	3	8.8%	7	14.3%	13	21.3%	9	13.2%	15	12.6%	16	17.2%	17	18.3%	42	19.7%	122	16.7%
4と回答																		
男性	0	0.0%	4	14.3%	1	3.4%	0	0.0%	0	0.0%	3	6.0%	1	2.2%	13	13.3%	22	6.3%
女性	0	0.0%	1	4.8%	1	3.1%	1	2.9%	2	2.8%	0	0.0%	0	0.0%	12	10.4%	17	4.5%
男女合計	0	0.0%	5	10.2%	2	3.3%	1	1.5%	2	1.7%	3	3.2%	1	1.1%	25	11.7%	39	5.3%
無回答																		
男性	0	0.0%	0	0.0%	0	0.0%	0	0.0%	0	0.0%	1	2.0%	0	0.0%	2	2.0%	3	0.9%
女性	0	0.0%	0	0.0%	0	0.0%	0	0.0%	0	0.0%	0	0.0%	1	2.1%	4	3.5%	6	1.6%
男女合計	0	0.0%	0	0.0%	0	0.0%	1	1.5%	0	0.0%	1	1.1%	1	1.1%	6	2.8%	9	1.2%
全体(人)																		
男性	20		28		29		34		47		50		45		98		351	
女性	14		21		32		34		72		43		48		115		379	
男女合計	34		49		61		68		119		93		93		213		730	

南 会 津

	10	割合	20	割合	30	割合	40	割合	50	割合	64	割合	69	割合	70～	割合	全体数	割合
1と回答																		
男性	0	0.0%	0	0.0%	0	0.0%	1	11.1%	1	14.3%	0	0.0%	0	0.0%	2	9.1%	4	7.7%
女性	2	100.0%	0	0.0%	0	0.0%	1	16.7%	0	0.0%	0	0.0%	0	0.0%	0	0.0%	3	6.4%
男女合計	2	100.0%	0	0.0%	0	0.0%	2	13.3%	1	9.1%	0	0.0%	0	0.0%	2	4.8%	7	7.1%
2と回答																		
男性	0	0.0%	2	66.7%	2	66.7%	6	66.7%	4	57.1%	1	50.0%	5	83.3%	16	72.7%	36	69.2%
女性	0	0.0%	2	100.0%	0	0.0%	5	83.3%	3	75.0%	4	80.0%	6	85.7%	17	85.0%	37	78.7%
男女合計	0	0.0%	4	80.0%	2	50.0%	11	73.3%	7	63.6%	5	71.4%	11	84.6%	33	78.6%	73	73.7%
3と回答																		
男性	0	0.0%	1	33.3%	1	33.3%	1	11.1%	1	14.3%	0	0.0%	1	16.7%	2	9.1%	7	13.5%
女性	0	0.0%	0	0.0%	1	100.0%	0	0.0%	1	25.0%	1	20.0%	1	14.3%	2	10.0%	6	12.8%
男女合計	0	0.0%	1	20.0%	2	50.0%	1	6.7%	2	18.2%	1	14.3%	2	15.4%	4	9.5%	13	13.1%
4と回答																		
男性	0	0.0%	0	0.0%	0	0.0%	1	11.1%	1	14.3%	1	50.0%	0	0.0%	2	9.1%	5	9.6%
女性	0	0.0%	0	0.0%	0	0.0%	0	0.0%	0	0.0%	0	0.0%	0	0.0%	1	5.0%	1	2.1%
男女合計	0	0.0%	0	0.0%	0	0.0%	1	6.7%	1	9.1%	1	14.3%	0	0.0%	3	7.1%	6	6.1%
無回答																		
男性	0	0.0%	0	0.0%	0	0.0%	0	0.0%	0	0.0%	0	0.0%	0	0.0%	0	0.0%	0	0.0%
女性	0	0.0%	0	0.0%	0	0.0%	0	0.0%	0	0.0%	0	0.0%	0	0.0%	0	0.0%	0	0.0%
男女合計	0	0.0%	0	0.0%	0	0.0%	0	0.0%	0	0.0%	0	0.0%	0	0.0%	0	0.0%	0	0.0%
全体(人)																		
男性	0		3		3		9		7		2		6		22		52	
女性	2		2		1		6		4		5		7		20		47	
男女合計	2		5		4		15		11		7		13		42		99	

相 双

	10	割合	20	割合	30	割合	40	割合	50	割合	64	割合	69	割合	70～	割合	全体数	割合
1と回答																		
男性	1	20.0%	0	0.0%	1	16.7%	1	6.7%	0	0.0%	2	10.5%	1	3.7%	1	1.3%	7	4.4%
女性	4	50.0%	1	16.7%	1	16.7%	2	11.1%	0	0.0%	1	5.6%	3	13.0%	1	1.6%	13	8.2%
男女合計	5	38.5%	1	12.5%	2	16.7%	3	9.1%	0	0.0%	3	8.1%	4	8.0%	2	1.4%	20	6.3%
2と回答																		
男性	4	80.0%	1	50.0%	4	66.7%	13	86.7%	5	55.6%	11	57.9%	21	77.8%	50	64.9%	109	68.1%
女性	4	50.0%	1	16.7%	4	66.7%	14	77.8%	11	64.7%	14	77.8%	12	52.2%	39	61.9%	99	62.3%
男女合計	8	61.5%	2	25.0%	8	66.7%	27	81.8%	16	61.5%	25	67.6%	33	66.0%	89	63.6%	208	65.2%
3と回答																		
男性	0	0.0%	1	50.0%	1	16.7%	1	6.7%	3	33.3%	5	26.3%	3	11.1%	18	23.4%	32	20.0%
女性	0	0.0%	2	33.3%	1	16.7%	2	11.1%	5	29.4%	2	11.1%	7	30.4%	18	28.6%	37	23.3%
男女合計	0	0.0%	3	37.5%	2	16.7%	3	9.1%	8	30.8%	7	18.9%	10	20.0%	36	25.7%	69	21.6%
4と回答																		
男性	0	0.0%	0	0.0%	0	0.0%	0	0.0%	1	11.1%	1	5.3%	2	7.4%	7	9.1%	11	6.9%
女性	0	0.0%	2	33.3%	0	0.0%	0	0.0%	1	5.9%	1	5.6%	1	4.3%	5	7.9%	10	6.3%
男女合計	0	0.0%	2	25.0%	0	0.0%	0	0.0%	2	7.7%	2	5.4%	3	6.0%	12	8.6%	21	6.6%
無回答																		
男性	0	0.0%	0	0.0%	0	0.0%	0	0.0%	0	0.0%	0	0.0%	0	0.0%	1	1.3%	1	0.6%
女性	0	0.0%	0	0.0%	0	0.0%	0	0.0%	0	0.0%	0	0.0%	0	0.0%	0	0.0%	0	0.0%
男女合計	0	0.0%	0	0.0%	0	0.0%	0	0.0%	0	0.0%	0	0.0%	0	0.0%	1	0.7%	1	0.3%
全体(人)																		
男性	5		2		6		15		9		19		27		77		160	
女性	8		6		6		18		17		18		23		63		159	
男女合計	13		8		12		33		26		37		50		140		319	

いわき

	10	割合	20	割合	30	割合	40	割合	50	割合	64	割合	69	割合	70～	割合	全体数	割合
1と回答																		
男性	10	52.6%	5	21.7%	8	15.7%	2	3.3%	3	4.4%	2	5.7%	3	7.9%	5	3.6%	38	8.8%
女性	4	26.7%	4	12.9%	3	6.7%	7	11.5%	5	7.9%	3	7.3%	2	4.1%	8	5.1%	36	7.8%
男女合計	14	41.2%	9	16.7%	11	11.5%	9	7.4%	8	6.1%	5	6.6%	5	5.7%	13	4.4%	74	8.3%
2と回答																		
男性	7	36.8%	13	56.5%	34	66.7%	43	71.7%	49	72.1%	24	68.6%	22	57.9%	102	74.5%	294	68.2%
女性	10	66.7%	21	67.7%	34	75.6%	38	62.3%	42	66.7%	31	75.6%	36	73.5%	105	66.9%	317	68.6%
男女合計	17	50.0%	34	63.0%	68	70.8%	81	66.9%	91	69.5%	55	72.4%	58	66.7%	207	70.4%	611	68.4%
3と回答																		
男性	1	5.3%	4	17.4%	7	13.7%	14	23.3%	8	11.8%	7	20.0%	11	28.9%	19	13.9%	71	16.5%
女性	1	6.7%	6	19.4%	6	13.3%	13	21.3%	13	20.6%	4	9.8%	10	20.4%	30	19.1%	83	18.0%
男女合計	2	5.9%	10	18.5%	13	13.5%	27	22.3%	21	16.0%	11	14.5%	21	24.1%	49	16.7%	154	17.2%
4と回答																		
男性	0	0.0%	1	4.3%	2	3.9%	1	1.7%	8	11.8%	2	5.7%	2	5.3%	9	6.6%	25	5.8%
女性	0	0.0%	0	0.0%	2	4.4%	3	4.9%	2	3.2%	3	7.3%	1	2.0%	12	7.6%	23	5.0%
男女合計	0	0.0%	1	1.9%	4	4.2%	4	3.3%	10	7.6%	5	6.6%	3	3.4%	21	7.1%	48	5.4%
無回答																		
男性	1	5.3%	0	0.0%	0	0.0%	0	0.0%	0	0.0%	0	0.0%	0	0.0%	2	1.5%	3	0.7%
女性	0	0.0%	0	0.0%	0	0.0%	0	0.0%	1	1.6%	0	0.0%	0	0.0%	2	1.3%	3	0.6%
男女合計	1	2.9%	0	0.0%	0	0.0%	0	0.0%	1	0.8%	0	0.0%	0	0.0%	4	1.4%	6	0.7%
全体(人)																		
男性	19		23		51		60		68		35		38		137		431	
女性	15		31		45		61		63		41		49		157		462	
男女合計	34		54		96		121		131		76		87		294		893	

全県(60歳以上・再掲)

	64	割合	69	割合	70	割合	80	割合	90	割合	全体数	割合
1と回答												
男性	14	5.3%	17	6.0%	25	5.0%	13	4.8%	7	18.4%	76	5.6%
女性	16	6.2%	22	7.2%	29	5.7%	14	4.3%	7	8.4%	88	5.9%
男女合計	30	5.7%	39	6.6%	54	5.4%	27	4.5%	14	11.6%	164	5.8%
2と回答												
男性	177	67.3%	198	69.5%	332	66.8%	170	62.7%	16	42.1%	893	66.0%
女性	194	74.6%	227	74.2%	346	68.0%	184	57.0%	41	49.4%	992	67.0%
男女合計	371	70.9%	425	71.9%	678	67.4%	354	59.6%	57	47.1%	1885	66.5%
3と回答												
男性	47	17.9%	53	18.6%	99	19.9%	53	19.6%	10	26.3%	262	19.4%
女性	39	15.0%	44	14.4%	91	17.9%	71	22.0%	15	18.1%	260	17.6%
男女合計	86	16.4%	97	16.4%	190	18.9%	124	20.9%	25	20.7%	522	18.4%
4と回答												
男性	20	7.6%	17	6.0%	34	6.8%	33	12.2%	4	10.5%	108	8.0%
女性	10	3.8%	11	3.6%	39	7.7%	46	14.2%	18	21.7%	124	8.4%
男女合計	30	5.7%	28	4.7%	73	7.3%	79	13.3%	22	18.2%	232	8.2%
無回答												
男性	5	1.9%	0	0.0%	7	1.4%	2	0.7%	1	2.6%	15	1.1%
女性	1	0.4%	2	0.7%	4	0.8%	8	2.5%	2	2.4%	17	1.1%
男女合計	6	1.1%	2	0.3%	11	1.1%	10	1.7%	3	2.5%	32	1.1%
全体(人)												
男性	263		285		497		271		38		1354	
女性	260		306		509		323		83		1481	
男女合計	523		591		1006		594		121		2835	

2 健康づくりのために気をつけていること（調査票 問2）

問2 あなたは、健康づくりのためにどのようなことに気をつけていますか。（あてはまる番号すべてに○）

- 1 食生活に気をつけている
- 2 歩いたり軽い体操をしている
- 3 スポーツやランニングをしている
- 4 休養や睡眠を十分とるようにしている
- 5 酒を控えるようにしている
- 6 たばこを吸わないようにしている
- 7 定期的に健康診断を受けるようにしている
- 8 趣味や生きがいをもち、生活にメリハリを持たせるようにしている
- 9 健康補助食品などを利用している
- 10 その他
- 11 特に何もしていない

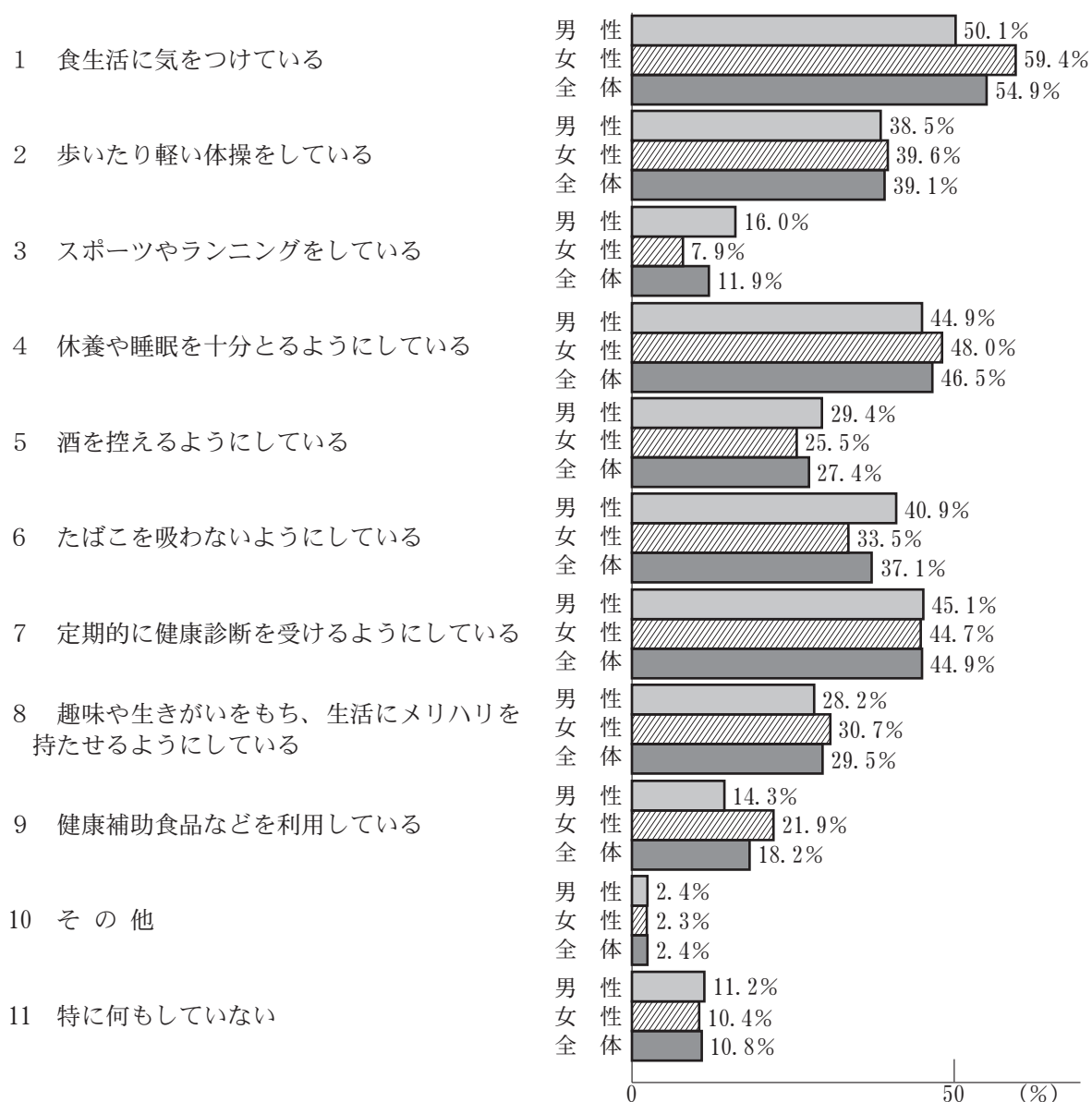

1. 食生活に気をつけていると回答した人

	10	割合	20	割合	30	割合	40	割合	50	割合	64	割合	69	割合	70	割合	80	割合	90	割合	全体数	割合
1に○																						
男性	38	31.9%	48	28.9%	76	30.3%	137	36.6%	182	46.4%	147	55.9%	167	58.6%	322	64.8%	188	69.4%	25	65.8%	1330	50.1%
女性	36	29.0%	68	38.0%	114	46.3%	166	48.8%	258	58.5%	166	63.8%	232	75.8%	378	74.3%	212	65.6%	41	49.4%	1671	59.4%
男女合計	74	30.5%	116	33.6%	190	38.2%	303	42.4%	440	52.8%	313	59.8%	399	67.5%	700	69.6%	400	67.3%	66	54.5%	3001	54.9%
全体(人)																						
男性	119		166		251		374		392		263		285		497		271		38		2656	
女性	124		179		246		340		441		260		306		509		323		83		2811	
男女合計	243		345		497		714		833		523		591		1006		594		121		5467	

2. 歩いたり軽い体操をしていると回答した人

	10	割合	20	割合	30	割合	40	割合	50	割合	64	割合	69	割合	70	割合	80	割合	90	割合	全体数	割合
2に○																						
男性	33	27.7%	42	25.3%	68	27.1%	100	26.7%	121	30.9%	94	35.7%	143	50.2%	262	52.7%	144	53.1%	16	42.1%	1023	38.5%
女性	34	27.4%	48	26.8%	65	26.4%	95	27.9%	153	34.7%	113	43.5%	149	48.7%	287	56.4%	149	46.1%	21	25.3%	1114	39.6%
男女合計	67	27.6%	90	26.1%	133	26.8%	195	27.3%	274	32.9%	207	39.6%	292	49.4%	549	54.6%	293	49.3%	37	30.6%	2137	39.1%
全体(人)																						
男性	119		166		251		374		392		263		285		497		271		38		2656	
女性	124		179		246		340		441		260		306		509		323		83		2811	
男女合計	243		345		497		714		833		523		591		1006		594		121		5467	

3. スポーツやランニングをしていると回答した人

	10	割合	20	割合	30	割合	40	割合	50	割合	64	割合	69	割合	70	割合	80	割合	90	割合	全体数	割合
3に○																						
男性	53	44.5%	43	25.9%	37	14.7%	72	19.3%	48	12.2%	31	11.8%	47	16.5%	65	13.1%	28	10.3%	1	2.6%	425	16.0%
女性	23	18.5%	14	7.8%	12	4.9%	20	5.9%	27	6.1%	17	6.5%	33	10.8%	49	9.6%	26	8.0%	2	2.4%	223	7.9%
男女合計	76	31.3%	57	16.5%	49	9.9%	92	12.9%	75	9.0%	48	9.2%	80	13.5%	114	11.3%	54	9.1%	3	2.5%	648	11.9%
全体(人)																						
男性	119		166		251		374		392		263		285		497		271		38		2656	
女性	124		179		246		340		441		260		306		509		323		83		2811	
男女合計	243		345		497		714		833		523		591		1006		594		121		5467	

4. 休養や睡眠を十分とるようにしていると回答した人

	10	割合	20	割合	30	割合	40	割合	50	割合	64	割合	69	割合	70	割合	80	割合	90	割合	全体数	割合
4に○																						
男性	38	31.9%	56	33.7%	95	37.8%	116	31.0%	148	37.8%	120	45.6%	145	50.9%	284	57.1%	164	60.5%	26	68.4%	1192	44.9%
女性	51	41.1%	80	44.7%	110	44.7%	171	50.3%	178	40.4%	115	44.2%	151	49.3%	275	54.0%	183	56.7%	35	42.2%	1349	48.0%
男女合計	89	36.6%	136	39.4%	205	41.2%	287	40.2%	326	39.1%	235	44.9%	296	50.1%	559	55.6%	347	58.4%	61	50.4%	2541	46.5%
全体(人)																						
男性	119		166		251		374		392		263		285		497		271		38		2656	
女性	124		179		246		340		441		260		306		509		323		83		2811	
男女合計	243		345		497		714		833		523		591		1006		594		121		5467	

5. 酒を控えるようにしていると回答した人

	10	割合	20	割合	30	割合	40	割合	50	割合	64	割合	69	割合	70	割合	80	割合	90	割合	全体数	割合
5に○																						
男性	11	9.2%	55	33.1%	66	26.3%	93	24.9%	83	21.2%	67	25.5%	84	29.5%	188	37.8%	116	42.8%	17	44.7%	780	29.4%
女性	12	9.7%	61	34.1%	84	34.1%	88	25.9%	118	26.8%	70	26.9%	80	26.1%	146	28.7%	52	16.1%	6	7.2%	717	25.5%
男女合計	23	9.5%	116	33.6%	150	30.2%	181	25.4%	201	24.1%	137	26.2%	164	27.7%	334	33.2%	168	28.3%	23	19.0%	1497	27.4%
全体(人)																						
男性	119		166		251		374		392		263		285		497		271		38		2656	
女性	124		179		246		340		441		260		306		509		323		83		2811	
男女合計	243		345		497		714		833		523		591		1006		594		121		5467	

6. たばこを吸わないようにしていると回答した人

	10	割合	20	割合	30	割合	40	割合	50	割合	64	割合	69	割合	70	割合	80	割合	90	割合	全体数	割合
6に○																						
男性	18	15.1%	72	43.4%	88	35.1%	149	39.8%	136	34.7%	115	43.7%	134	47.0%	236	47.5%	123	45.4%	14	36.8%	1085	40.9%
女性	15	12.1%	89	49.7%	119	48.4%	149	43.8%	167	37.9%	87	33.5%	94	30.7%	158	31.0%	57	17.6%	6	7.2%	941	33.5%
男女合計	33	13.6%	161	46.7%	207	41.6%	298	41.7%	303	36.4%	202	38.6%	228	38.6%	394	39.2%	180	30.3%	20	16.5%	2026	37.1%
全体(人)																						
男性	119		166		251		374		392		263		285		497		271		38		2656	
女性	124		179		246		340		441		260		306		509		323		83		2811	
男女合計	243		345		497		714		833		523		591		1006		594		121		5467	

7. 定期的に健康診断を受けるようにしていると回答した人

	10	割合	20	割合	30	割合	40	割合	50	割合	64	割合	69	割合	70	割合	80	割合	90	割合	全体数	割合
7に○																						
男性	7	5.9%	27	16.3%	67	26.7%	142	38.0%	192	49.0%	142	54.0%	164	57.5%	279	56.1%	163	60.1%	16	42.1%	1199	45.1%
女性	6	4.8%	44	24.6%	84	34.1%	160	47.1%	218	49.4%	127	48.8%	166	54.2%	281	55.2%	145	44.9%	25	30.1%	1256	44.7%
男女合計	13	5.3%	71	20.6%	151	30.4%	302	42.3%	410	49.2%	269	51.4%	330	55.8%	560	55.7%	308	51.9%	41	33.9%	2455	44.9%
全体(人)																						
男性	119		166		251		374		392		263		285		497		271		38		2656	
女性	124		179		246		340		441		260		306		509		323		83		2811	
男女合計	243		345		497		714		833		523		591		1006		594		121		5467	

8. 趣味や生きがいをもち、生活にメリハリを持たせようしていると回答した人

	10	割合	20	割合	30	割合	40	割合	50	割合	64	割合	69	割合	70	割合	80	割合	90	割合	全体数	割合
8に○																						
男性	28	23.5%	47	28.3%	71	28.3%	76	20.3%	86	21.9%	74	28.1%	97	34.0%	180	36.2%	76	28.0%	14	36.8%	749	28.2%
女性	34	27.4%	46	25.7%	59	24.0%	75	22.1%	117	26.5%	85	32.7%	115	37.6%	215	42.2%	104	32.2%	12	14.5%	862	30.7%
男女合計	62	25.5%	93	27.0%	130	26.2%	151	21.1%	203	24.4%	159	30.4%	212	35.9%	395	39.3%	180	30.3%	26	21.5%	1611	29.5%
全体(人)																						
男性	119		166		251		374		392		263		285		497		271		38		2656	
女性	124		179		246		340		441		260		306		509		323		83		2811	
男女合計	243		345		497		714		833		523		591		1006		594		121		5467	

9. 健康補助食品などを利用していると回答した人

	10	割合	20	割合	30	割合	40	割合	50	割合	64	割合	69	割合	70	割合	80	割合	90	割合	全体数	割合
9に○																						
男性	7	5.9%	12	7.2%	31	12.4%	52	13.9%	62	15.8%	43	16.3%	48	16.8%	69	13.9%	53	19.6%	3	7.9%	380	14.3%
女性	9	7.3%	21	11.7%	59	24.0%	67	19.7%	105	23.8%	66	25.4%	79	25.8%	133	26.1%	71	22.0%	6	7.2%	616	21.9%
男女合計	16	6.6%	33	9.6%	90	18.1%	119	16.7%	167	20.0%	109	20.8%	127	21.5%	202	20.1%	124	20.9%	9	7.4%	996	18.2%
全体(人)																						
男性	119		166		251		374		392		263		285		497		271		38		2656	
女性	124		179		246		340		441		260		306		509		323		83		2811	
男女合計	243		345		497		714		833		523		591		1006		594		121		5467	

10. その他と回答した人

	10	割合	20	割合	30	割合	40	割合	50	割合	64	割合	69	割合	70	割合	80	割合	90	割合	全体数	割合
10に○																						
男性	1	0.8%	0	0.0%	1	0.4%	3	0.8%	10	2.6%	5	1.9%	8	2.8%	16	3.2%	17	6.3%	3	7.9%	64	2.4%
女性	0	0.0%	4	2.2%	1	0.4%	2	0.6%	4	0.9%	4	1.5%	13	4.2%	19	3.7%	15	4.6%	3	3.6%	65	2.3%
男女合計	1	0.4%	4	1.2%	2	0.4%	5	0.7%	14	1.7%	9	1.7%	21	3.6%	35	3.5%	32	5.4%	6	5.0%	129	2.4%
全体(人)																						
男性	119		166		251		374		392		263		285		497		271		38		2656	
女性	124		179		246		340		441		260		306		509		323		83		2811	
男女合計	243		345		497		714		833		523		591		1006		594		121		5467	

11. 特に何もしていないと回答した人

	10	割合	20	割合	30	割合	40	割合	50	割合	64	割合	69	割合	70	割合	80	割合	90	割合	全体数	割合
11に○																						
男性	21	17.6%	31	18.7%	45	17.9%	57	15.2%	51	13.0%	23	8.7%	22	7.7%	27	5.4%	18	6.6%	2	5.3%	297	11.2%
女性	25	20.2%	29	16.2%	34	13.8%	33	9.7%	42	9.5%	29	11.2%	23	7.5%	25	4.9%	29	9.0%	22	26.5%	291	10.4%
男女合計	46	18.9%	60	17.4%	79	15.9%	90	12.6%	93	11.2%	52	9.9%	45	7.6%	52	5.2%	47	7.9%	24	19.8%	588	10.8%
全体(人)																						
男性	119		166		251		374		392		263		285		497		271		38		2656	
女性	124		179		246		340		441		260		306		509		323		83		2811	
男女合計	243		345		497		714		833		523		591		1006		594		121		5467	

3 「県民健康の日」の認知度（調査票 問3）

問3 あなたは、福島県において、10月10日が「県民健康の日」であることを知っていますか。

1 知っている 2 知らない

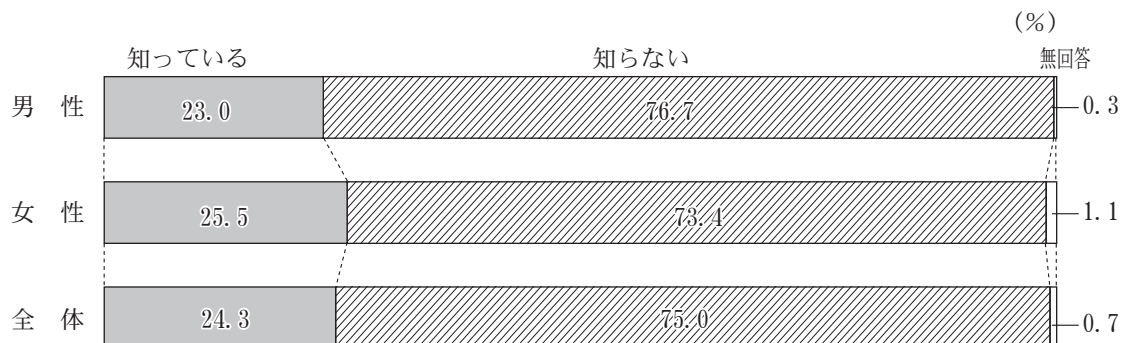

	10	割合	20	割合	30	割合	40	割合	50	割合	64	割合	69	割合	70	割合	80	割合	90	割合	全体数	割合		
1と回答																								
男性	9	7.6%	17	10.2%	25	10.0%	57	15.2%	77	19.6%	54	20.5%	81	28.4%	166	33.4%	115	42.4%	10	26.3%	611	23.0%		
女性	9	7.3%	22	12.3%	31	12.6%	62	18.2%	99	22.4%	61	23.5%	104	34.0%	194	38.1%	120	37.2%	15	18.1%	717	25.5%		
男女合計	18	7.4%	39	11.3%	56	11.3%	119	16.7%	176	21.1%	115	22.0%	185	31.3%	360	35.8%	235	39.6%	25	20.7%	1328	24.3%		
2と回答																								
男性	110	92.4%	149	89.8%	226	90.0%	316	84.5%	315	80.4%	209	79.5%	203	71.2%	328	66.0%	153	56.5%	28	73.7%	2037	76.7%		
女性	113	91.1%	156	87.2%	215	87.4%	277	81.5%	342	77.6%	199	76.5%	197	64.4%	308	60.5%	189	58.5%	66	79.5%	2062	73.4%		
男女合計	223	91.8%	305	88.4%	441	88.7%	593	83.1%	657	78.9%	408	78.0%	400	67.7%	636	63.2%	342	57.6%	94	77.7%	4099	75.0%		
無回答																								
男性	0	0.0%	0	0.0%	0	0.0%	1	0.3%	0	0.0%	0	0.0%	0	0.0%	1	0.4%	3	0.6%	3	1.1%	0	0.0%	8	0.3%
女性	2	1.6%	1	0.6%	0	0.0%	1	0.3%	0	0.0%	0	0.0%	0	0.0%	5	1.6%	7	1.4%	14	4.3%	2	2.4%	32	1.1%
男女合計	2	0.8%	1	0.3%	0	0.0%	2	0.3%	0	0.0%	0	0.0%	0	0.0%	6	1.0%	10	1.0%	17	2.9%	2	1.7%	40	0.7%
全体(人)																								
男性	119	166	251	374	392	263	285	497	271	38											2656			
女性	124	179	246	340	441	260	306	509	323	83											2811			
男女合計	243	345	497	714	833	523	591	1006	594	121											5467			

県 北

	10	割合	20	割合	30	割合	40	割合	50	割合	64	割合	69	割合	70～	割合	全体数	割合
1と回答																		
男性	1	2.9%	6	12.5%	15	16.3%	23	18.0%	26	22.0%	14	22.6%	16	27.1%	66	34.7%	167	22.8%
女性	3	8.1%	6	11.8%	13	14.8%	18	17.5%	27	20.0%	18	28.6%	25	30.5%	85	36.5%	195	24.6%
男女合計	4	5.6%	12	12.1%	28	15.6%	41	17.7%	53	20.9%	32	25.6%	41	29.1%	151	35.7%	362	23.8%
2と回答																		
男性	34	97.1%	42	87.5%	77	83.7%	104	81.3%	92	78.0%	48	77.4%	42	71.2%	122	64.2%	561	76.6%
女性	34	91.9%	45	88.2%	75	85.2%	85	82.5%	108	80.0%	45	71.4%	55	67.1%	141	60.5%	588	74.2%
男女合計	68	94.4%	87	87.9%	152	84.4%	189	81.8%	200	79.1%	93	74.4%	97	68.8%	263	62.2%	1149	75.4%
無回答																		
男性	0	0.0%	0	0.0%	0	0.0%	1	0.8%	0	0.0%	0	0.0%	1	1.7%	2	1.1%	4	0.5%
女性	0	0.0%	0	0.0%	0	0.0%	0	0.0%	0	0.0%	0	0.0%	2	2.4%	7	3.0%	9	1.1%
男女合計	0	0.0%	0	0.0%	0	0.0%	1	0.4%	0	0.0%	0	0.0%	3	2.1%	9	2.1%	13	0.9%
全体(人)																		
男性	35		48		92		128		118		62		59		190		732	
女性	37		51		88		103		135		63		82		233		792	
男女合計	72		99		180		231		253		125		141		423		1524	

県 中

	10	割合	20	割合	30	割合	40	割合	50	割合	64	割合	69	割合	70～	割合	全体数	割合
1と回答																		
男性	2	6.1%	3	7.7%	2	4.2%	12	13.2%	19	17.4%	7	11.1%	22	28.6%	68	34.5%	135	20.5%
女性	1	3.4%	7	13.7%	8	14.3%	20	22.2%	28	26.9%	10	17.2%	24	35.3%	76	33.0%	174	25.4%
男女合計	3	4.8%	10	11.1%	10	9.6%	32	17.7%	47	22.1%	17	14.0%	46	31.7%	144	33.7%	309	23.0%
2と回答																		
男性	31	93.9%	36	92.3%	46	95.8%	79	86.8%	90	82.6%	56	88.9%	55	71.4%	128	65.0%	521	79.3%
女性	28	96.6%	44	86.3%	48	85.7%	69	76.7%	76	73.1%	48	82.8%	44	64.7%	150	65.2%	507	73.9%
男女合計	59	95.2%	80	88.9%	94	90.4%	148	81.8%	166	77.9%	104	86.0%	99	68.3%	278	65.1%	1028	76.5%
無回答																		
男性	0	0.0%	0	0.0%	0	0.0%	0	0.0%	0	0.0%	0	0.0%	0	0.0%	1	0.5%	1	0.2%
女性	0	0.0%	0	0.0%	0	0.0%	1	1.1%	0	0.0%	0	0.0%	0	0.0%	4	1.7%	5	0.7%
男女合計	0	0.0%	0	0.0%	0	0.0%	1	0.6%	0	0.0%	0	0.0%	0	0.0%	5	1.2%	6	0.4%
全体(人)																		
男性	33		39		48		91		109		63		77		197		657	
女性	29		51		56		90		104		58		68		230		686	
男女合計	62		90		104		181		213		121		145		427		1343	

県 南

	10	割合	20	割合	30	割合	40	割合	50	割合	64	割合	69	割合	70～	割合	全体数	割合
1と回答																		
男性	2	28.6%	2	8.7%	2	9.1%	8	21.6%	7	20.6%	11	34.4%	12	36.4%	36	42.4%	80	29.3%
女性	3	15.8%	2	11.8%	4	22.2%	6	21.4%	12	26.1%	10	31.3%	13	44.8%	33	34.0%	83	29.0%
男女合計	5	19.2%	4	10.0%	6	15.0%	14	21.5%	19	23.8%	21	32.8%	25	40.3%	69	37.9%	163	29.2%
2と回答																		
男性	5	71.4%	21	91.3%	20	90.9%	29	78.4%	27	79.4%	21	65.6%	21	63.6%	48	56.5%	192	70.3%
女性	15	78.9%	15	88.2%	14	77.8%	22	78.6%	34	73.9%	22	68.8%	16	55.2%	60	61.9%	198	69.2%
男女合計	20	76.9%	36	90.0%	34	85.0%	51	78.5%	61	76.3%	43	67.2%	37	59.7%	108	59.3%	390	69.8%
無回答																		
男性	0	0.0%	0	0.0%	0	0.0%	0	0.0%	0	0.0%	0	0.0%	0	0.0%	1	1.2%	1	0.4%
女性	1	5.3%	0	0.0%	0	0.0%	0	0.0%	0	0.0%	0	0.0%	0	0.0%	4	4.1%	5	1.7%
男女合計	1	3.8%	0	0.0%	0	0.0%	0	0.0%	0	0.0%	0	0.0%	0	0.0%	5	2.7%	6	1.1%
全体(人)																		
男性	7		23		22		37		34		32		33		85		273	
女性	19		17		18		28		46		32		29		97		286	
男女合計	26		40		40		65		80		64		62		182		559	

会 津

	10	割合	20	割合	30	割合	40	割合	50	割合	64	割合	69	割合	70～	割合	全体数	割合
1と回答																		
男性	3	15.0%	2	7.1%	2	6.9%	4	11.8%	7	14.9%	6	12.0%	10	22.2%	34	34.7%	68	19.4%
女性	1	7.1%	3	14.3%	1	3.1%	3	8.8%	13	18.1%	9	20.9%	12	25.0%	46	40.0%	88	23.2%
男女合計	4	11.8%	5	10.2%	3	4.9%	7	10.3%	20	16.8%	15	16.1%	22	23.7%	80	37.6%	156	21.4%
2と回答																		
男性	17	85.0%	26	92.9%	27	93.1%	30	88.2%	40	85.1%	44	88.0%	35	77.8%	64	65.3%	283	80.6%
女性	12	85.7%	17	81.0%	31	96.9%	31	91.2%	59	81.9%	34	79.1%	34	70.8%	69	60.0%	287	75.7%
男女合計	29	85.3%	43	87.8%	58	95.1%	61	89.7%	99	83.2%	78	83.9%	69	74.2%	133	62.4%	570	78.1%
無回答																		
男性	0	0.0%	0	0.0%	0	0.0%	0	0.0%	0	0.0%	0	0.0%	0	0.0%	0	0.0%	0	0.0%
女性	1	7.1%	1	4.8%	0	0.0%	0	0.0%	0	0.0%	0	0.0%	2	4.2%	0	0.0%	4	1.1%
男女合計	1	2.9%	1	2.0%	0	0.0%	0	0.0%	0	0.0%	0	0.0%	2	2.2%	0	0.0%	4	0.5%
全体(人)																		
男性	20		28		29		34		47		50		45		98		351	
女性	14		21		32		34		72		43		48		115		379	
男女合計	34		49		61		68		119		93		93		213		730	

南会津

	10	割合	20	割合	30	割合	40	割合	50	割合	64	割合	69	割合	70～	割合	全体数	割合
1と回答																		
男性	0	0.0%	1	33.3%	1	33.3%	2	22.2%	3	42.9%	0	0.0%	0	0.0%	7	31.8%	14	26.9%
女性	0	0.0%	1	50.0%	0	0.0%	1	16.7%	2	50.0%	1	20.0%	2	28.6%	11	55.0%	18	38.3%
男女合計	0	0.0%	2	40.0%	1	25.0%	3	20.0%	5	45.5%	1	14.3%	2	15.4%	18	42.9%	32	32.3%
2と回答																		
男性	0	0.0%	2	66.7%	2	66.7%	7	77.8%	4	57.1%	2	100.0%	6	100.0%	15	68.2%	38	73.1%
女性	2	100.0%	1	50.0%	1	100.0%	5	83.3%	2	50.0%	4	80.0%	4	57.1%	9	45.0%	28	59.6%
男女合計	2	100.0%	3	60.0%	3	75.0%	12	80.0%	6	54.5%	6	85.7%	10	76.9%	24	57.1%	66	66.7%
無回答																		
男性	0	0.0%	0	0.0%	0	0.0%	0	0.0%	0	0.0%	0	0.0%	0	0.0%	0	0.0%	0	0.0%
女性	0	0.0%	0	0.0%	0	0.0%	0	0.0%	0	0.0%	0	0.0%	1	14.3%	0	0.0%	1	2.1%
男女合計	0	0.0%	0	0.0%	0	0.0%	0	0.0%	0	0.0%	0	0.0%	1	7.7%	0	0.0%	1	1.0%
全体(人)																		
男性	0		3		3		9		7		2		6		22		52	
女性	2		2		1		6		4		5		7		20		47	
男女合計	2		5		4		15		11		7		13		42		99	

相 双

	10	割合	20	割合	30	割合	40	割合	50	割合	64	割合	69	割合	70～	割合	全体数	割合
1と回答																		
男性	0	0.0%	0	0.0%	0	0.0%	3	20.0%	2	22.2%	6	31.6%	9	33.3%	25	32.5%	45	28.1%
女性	0	0.0%	0	0.0%	0	0.0%	3	16.7%	5	29.4%	4	22.2%	10	43.5%	17	27.0%	39	24.5%
男女合計	0	0.0%	0	0.0%	0	0.0%	6	18.2%	7	26.9%	10	27.0%	19	38.0%	42	30.0%	84	26.3%
2と回答																		
男性	5	100.0%	2	100.0%	6	100.0%	12	80.0%	7	77.8%	13	68.4%	18	66.7%	52	67.5%	115	71.9%
女性	8	100.0%	6	100.0%	6	100.0%	15	83.3%	12	70.6%	14	77.8%	13	56.5%	42	66.7%	116	73.0%
男女合計	13	100.0%	8	100.0%	12	100.0%	27	81.8%	19	73.1%	27	73.0%	31	62.0%	94	67.1%	231	72.4%
無回答																		
男性	0	0.0%	0	0.0%	0	0.0%	0	0.0%	0	0.0%	0	0.0%	0	0.0%	0	0.0%	0	0.0%
女性	0	0.0%	0	0.0%	0	0.0%	0	0.0%	0	0.0%	0	0.0%	0	0.0%	4	6.3%	4	2.5%
男女合計	0	0.0%	0	0.0%	0	0.0%	0	0.0%	0	0.0%	0	0.0%	0	0.0%	4	2.9%	4	1.3%
全体(人)																		
男性	5		2		6		15		9		19		27		77		160	
女性	8		6		6		18		17		18		23		63		159	
男女合計	13		8		12		33		26		37		50		140		319	

いわき

	10	割合	20	割合	30	割合	40	割合	50	割合	64	割合	69	割合	70～	割合	全体数	割合
1と回答																		
男性	1	5.3%	3	13.0%	3	5.9%	5	8.3%	13	19.1%	10	28.6%	12	31.6%	55	40.1%	102	23.7%
女性	1	6.7%	3	9.7%	5	11.1%	11	18.0%	12	19.0%	9	22.0%	18	36.7%	61	38.9%	120	26.0%
男女合計	2	5.9%	6	11.1%	8	8.3%	16	13.2%	25	19.1%	19	25.0%	30	34.5%	116	39.5%	222	24.9%
2と回答																		
男性	18	94.7%	20	87.0%	48	94.1%	55	91.7%	55	80.9%	25	71.4%	26	68.4%	80	58.4%	327	75.9%
女性	14	93.3%	28	90.3%	40	88.9%	50	82.0%	51	81.0%	32	78.0%	31	63.3%	92	58.6%	338	73.2%
男女合計	32	94.1%	48	88.9%	88	91.7%	105	86.8%	106	80.9%	57	75.0%	57	65.5%	172	58.5%	665	74.5%
無回答																		
男性	0	0.0%	0	0.0%	0	0.0%	0	0.0%	0	0.0%	0	0.0%	0	0.0%	2	1.4%	2	0.5%
女性	0	0.0%	0	0.0%	0	0.0%	0	0.0%	0	0.0%	0	0.0%	0	0.0%	4	2.5%	4	0.9%
男女合計	0	0.0%	0	0.0%	0	0.0%	0	0.0%	0	0.0%	0	0.0%	0	0.0%	6	2.0%	6	0.7%
全体(人)																		
男性	19		23		51		60		68		35		38		137		431	
女性	15		31		45		61		63		41		49		157		462	
男女合計	34		54		96		121		131		76		87		294		893	

全県(60歳以上・再掲)

	64	割合	69	割合	70	割合	80	割合	90	割合	全体数	割合
1と回答												
男性	54	20.5%	81	28.4%	166	33.4%	115	42.4%	10	26.3%	426	31.5%
女性	61	23.5%	104	34.0%	194	38.1%	120	37.2%	15	18.1%	494	33.4%
男女合計	115	22.0%	185	31.3%	360	35.8%	235	39.6%	25	20.7%	920	32.5%
2と回答												
男性	209	79.5%	203	71.2%	328	66.0%	153	56.5%	28	73.7%	921	68.0%
女性	199	76.5%	197	64.4%	308	60.5%	189	58.5%	66	79.5%	959	64.8%
男女合計	408	78.0%	400	67.7%	636	63.2%	342	57.6%	94	77.7%	1880	66.3%
無回答												
男性	0	0.0%	1	0.4%	3	0.6%	3	1.1%	0	0.0%	7	0.5%
女性	0	0.0%	5	1.6%	7	1.4%	14	4.3%	2	2.4%	28	1.9%
男女合計	0	0.0%	6	1.0%	10	1.0%	17	2.9%	2	1.7%	35	1.2%
全体(人)												
男性	263		285		497		271		38		1354	
女性	260		306		509		323		83		1481	
男女合計	523		591		1006		594		121		2835	

4 食生活（朝食）の状況（調査票 問4）

問4 あなたは、朝食をだいたい毎日とっていますか。

1 はい 2 いいえ

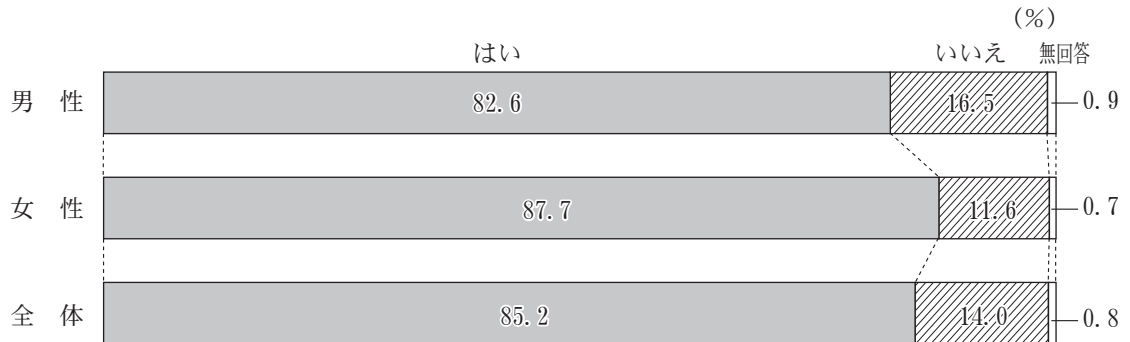

	10	割合	20	割合	30	割合	40	割合	50	割合	64	割合	69	割合	70	割合	80	割合	90	割合	全体数	割合
1と回答																						
男性	95	79.8%	97	58.4%	170	67.7%	270	72.2%	308	78.6%	223	84.8%	263	92.3%	475	95.6%	257	94.8%	36	94.7%	2194	82.6%
女性	101	81.5%	127	70.9%	195	79.3%	278	81.8%	375	85.0%	230	88.5%	287	93.8%	494	97.1%	300	92.9%	78	94.0%	2465	87.7%
男女合計	196	80.7%	224	64.9%	365	73.4%	548	76.8%	683	82.0%	453	86.6%	550	93.1%	969	96.3%	557	93.8%	114	94.2%	4659	85.2%
2と回答																						
男性	24	20.2%	68	41.0%	80	31.9%	100	26.7%	81	20.7%	40	15.2%	18	6.3%	17	3.4%	8	3.0%	2	5.3%	438	16.5%
女性	21	16.9%	51	28.5%	50	20.3%	61	17.9%	64	14.5%	29	11.2%	17	5.6%	13	2.6%	18	5.6%	2	2.4%	326	11.6%
男女合計	45	18.5%	119	34.5%	130	26.2%	161	22.5%	145	17.4%	69	13.2%	35	5.9%	30	3.0%	26	4.4%	4	3.3%	764	14.0%
無回答																						
男性	0	0.0%	1	0.6%	1	0.4%	4	1.1%	3	0.8%	0	0.0%	4	1.4%	5	1.0%	6	2.2%	0	0.0%	24	0.9%
女性	2	1.6%	1	0.6%	1	0.4%	1	0.3%	2	0.5%	1	0.4%	2	0.7%	2	0.4%	5	1.5%	3	3.6%	20	0.7%
男女合計	2	0.8%	2	0.6%	2	0.4%	5	0.7%	5	0.6%	1	0.2%	6	1.0%	7	0.7%	11	1.9%	3	2.5%	44	0.8%
全体(人)																						
男性	119		166		251		374		392		263		285		497		271		38		2656	
女性	124		179		246		340		441		260		306		509		323		83		2811	
男女合計	243		345		497		714		833		523		591		1006		594		121		5467	

県 北

	10	割合	20	割合	30	割合	40	割合	50	割合	64	割合	69	割合	70～	割合	全体数	割合
1と回答																		
男性	23	65.7%	27	56.3%	62	67.4%	94	73.4%	92	78.0%	53	85.5%	57	96.6%	176	92.6%	584	79.8%
女性	30	81.1%	39	76.5%	71	80.7%	84	81.6%	113	83.7%	58	92.1%	78	95.1%	219	94.0%	692	87.4%
男女合計	53	73.6%	66	66.7%	133	73.9%	178	77.1%	205	81.0%	111	88.8%	135	95.7%	395	93.4%	1276	83.7%
2と回答																		
男性	12	34.3%	20	41.7%	30	32.6%	32	25.0%	26	22.0%	9	14.5%	1	1.7%	11	5.8%	141	19.3%
女性	7	18.9%	12	23.5%	17	19.3%	19	18.4%	20	14.8%	5	7.9%	3	3.7%	13	5.6%	96	12.1%
男女合計	19	26.4%	32	32.3%	47	26.1%	51	22.1%	46	18.2%	14	11.2%	4	2.8%	24	5.7%	237	15.6%
無回答																		
男性	0	0.0%	1	2.1%	0	0.0%	2	1.6%	0	0.0%	0	0.0%	1	1.7%	3	1.6%	7	1.0%
女性	0	0.0%	0	0.0%	0	0.0%	0	0.0%	2	1.5%	0	0.0%	1	1.2%	1	0.4%	4	0.5%
男女合計	0	0.0%	1	1.0%	0	0.0%	2	0.9%	2	0.8%	0	0.0%	2	1.4%	4	0.9%	11	0.7%
全体(人)																		
男性	35		48		92		128		118		62		59		190		732	
女性	37		51		88		103		135		63		82		233		792	
男女合計	72		99		180		231		253		125		141		423		1524	

県 中

	10	割合	20	割合	30	割合	40	割合	50	割合	64	割合	69	割合	70～	割合	全体数	割合
1と回答																		
男性	30	90.9%	25	64.1%	35	72.9%	60	65.9%	81	74.3%	53	84.1%	71	92.2%	188	95.4%	543	82.6%
女性	22	75.9%	38	74.5%	51	91.1%	72	80.0%	86	82.7%	51	87.9%	64	94.1%	218	94.8%	602	87.8%
男女合計	52	83.9%	63	70.0%	86	82.7%	132	72.9%	167	78.4%	104	86.0%	135	93.1%	406	95.1%	1145	85.3%
2と回答																		
男性	3	9.1%	14	35.9%	13	27.1%	31	34.1%	27	24.8%	10	15.9%	6	7.8%	7	3.6%	111	16.9%
女性	7	24.1%	13	25.5%	5	8.9%	18	20.0%	18	17.3%	7	12.1%	4	5.9%	8	3.5%	80	11.7%
男女合計	10	16.1%	27	30.0%	18	17.3%	49	27.1%	45	21.1%	17	14.0%	10	6.9%	15	3.5%	191	14.2%
無回答																		
男性	0	0.0%	0	0.0%	0	0.0%	0	0.0%	1	0.9%	0	0.0%	0	0.0%	2	1.0%	3	0.5%
女性	0	0.0%	0	0.0%	0	0.0%	0	0.0%	0	0.0%	0	0.0%	0	0.0%	4	1.7%	4	0.6%
男女合計	0	0.0%	0	0.0%	0	0.0%	0	0.0%	1	0.5%	0	0.0%	0	0.0%	6	1.4%	7	0.5%
全体(人)																		
男性	33		39		48		91		109		63		77		197		657	
女性	29		51		56		90		104		58		68		230		686	
男女合計	62		90		104		181		213		121		145		427		1343	

県 南

	10	割合	20	割合	30	割合	40	割合	50	割合	64	割合	69	割合	70～	割合	全体数	割合
1と回答																		
男性	4	57.1%	12	52.2%	12	54.5%	28	75.7%	24	70.6%	28	87.5%	32	97.0%	82	96.5%	222	81.3%
女性	15	78.9%	12	70.6%	11	61.1%	25	89.3%	39	84.8%	29	90.6%	28	96.6%	96	99.0%	255	89.2%
男女合計	19	73.1%	24	60.0%	23	57.5%	53	81.5%	63	78.8%	57	89.1%	60	96.8%	178	97.8%	477	85.3%
2と回答																		
男性	3	42.9%	11	47.8%	10	45.5%	8	21.6%	9	26.5%	4	12.5%	0	0.0%	3	3.5%	48	17.6%
女性	3	15.8%	5	29.4%	6	33.3%	2	7.1%	7	15.2%	3	9.4%	1	3.4%	0	0.0%	27	9.4%
男女合計	6	23.1%	16	40.0%	16	40.0%	10	15.4%	16	20.0%	7	10.9%	1	1.6%	3	1.6%	75	13.4%
無回答																		
男性	0	0.0%	0	0.0%	0	0.0%	1	2.7%	1	2.9%	0	0.0%	1	3.0%	0	0.0%	3	1.1%
女性	1	5.3%	0	0.0%	1	5.6%	1	3.6%	0	0.0%	0	0.0%	0	0.0%	1	1.0%	4	1.4%
男女合計	1	3.8%	0	0.0%	1	2.5%	2	3.1%	1	1.3%	0	0.0%	1	1.6%	1	0.5%	7	1.3%
全体(人)																		
男性	7		23		22		37		34		32		33		85		273	
女性	19		17		18		28		46		32		29		97		286	
男女合計	26		40		40		65		80		64		62		182		559	

会 津

	10	割合	20	割合	30	割合	40	割合	50	割合	64	割合	69	割合	70～	割合	全体数	割合
1と回答																		
男性	17	85.0%	16	57.1%	23	79.3%	20	58.8%	39	83.0%	42	84.0%	37	82.2%	95	96.9%	289	82.3%
女性	13	92.9%	13	61.9%	24	75.0%	27	79.4%	61	84.7%	35	81.4%	44	91.7%	110	95.7%	327	86.3%
男女合計	30	88.2%	29	59.2%	47	77.0%	47	69.1%	100	84.0%	77	82.8%	81	87.1%	205	96.2%	616	84.4%
2と回答																		
男性	3	15.0%	12	42.9%	6	20.7%	13	38.2%	8	17.0%	8	16.0%	6	13.3%	3	3.1%	59	16.8%
女性	1	7.1%	7	33.3%	8	25.0%	7	20.6%	11	15.3%	7	16.3%	3	6.3%	4	3.5%	48	12.7%
男女合計	4	11.8%	19	38.8%	14	23.0%	20	29.4%	19	16.0%	15	16.1%	9	9.7%	7	3.3%	107	14.7%
無回答																		
男性	0	0.0%	0	0.0%	0	0.0%	1	2.9%	0	0.0%	0	0.0%	2	4.4%	0	0.0%	3	0.9%
女性	0	0.0%	1	4.8%	0	0.0%	0	0.0%	0	0.0%	1	2.3%	1	2.1%	1	0.9%	4	1.1%
男女合計	0	0.0%	1	2.0%	0	0.0%	1	1.5%	0	0.0%	1	1.1%	3	3.2%	1	0.5%	7	1.0%
全体(人)																		
男性	20		28		29		34		47		50		45		98		351	
女性	14		21		32		34		72		43		48		115		379	
男女合計	34		49		61		68		119		93		93		213		730	

南会津

	10	割合	20	割合	30	割合	40	割合	50	割合	64	割合	69	割合	70～	割合	全体数	割合
1と回答																		
男性	0	0.0%	1	33.3%	2	66.7%	7	77.8%	7	100.0%	2	100.0%	5	83.3%	20	90.9%	44	84.6%
女性	1	50.0%	1	50.0%	0	0.0%	4	66.7%	2	50.0%	5	100.0%	7	100.0%	18	90.0%	38	80.9%
男女合計	1	50.0%	2	40.0%	2	50.0%	11	73.3%	9	81.8%	7	100.0%	12	92.3%	38	90.5%	82	82.8%
2と回答																		
男性	0	0.0%	2	66.7%	0	0.0%	2	22.2%	0	0.0%	0	0.0%	1	16.7%	2	9.1%	7	13.5%
女性	1	50.0%	1	50.0%	1	100.0%	2	33.3%	2	50.0%	0	0.0%	0	0.0%	1	5.0%	8	17.0%
男女合計	1	50.0%	3	60.0%	1	25.0%	4	26.7%	2	18.2%	0	0.0%	1	7.7%	3	7.1%	15	15.2%
無回答																		
男性	0	0.0%	0	0.0%	1	33.3%	0	0.0%	0	0.0%	0	0.0%	0	0.0%	0	0.0%	1	1.9%
女性	0	0.0%	0	0.0%	0	0.0%	0	0.0%	0	0.0%	0	0.0%	0	0.0%	1	5.0%	1	2.1%
男女合計	0	0.0%	0	0.0%	1	25.0%	0	0.0%	0	0.0%	0	0.0%	0	0.0%	1	2.4%	2	2.0%
全体(人)																		
男性	0		3		3		9		7		2		6		22		52	
女性	2		2		1		6		4		5		7		20		47	
男女合計	2		5		4		15		11		7		13		42		99	

相 双

	10	割合	20	割合	30	割合	40	割合	50	割合	64	割合	69	割合	70～	割合	全体数	割合
1と回答																		
男性	5	100.0%	2	100.0%	5	83.3%	12	80.0%	9	100.0%	15	78.9%	26	96.3%	75	97.4%	149	93.1%
女性	7	87.5%	2	33.3%	4	66.7%	12	66.7%	16	94.1%	17	94.4%	22	95.7%	60	95.2%	140	88.1%
男女合計	12	92.3%	4	50.0%	9	75.0%	24	72.7%	25	96.2%	32	86.5%	48	96.0%	135	96.4%	289	90.6%
2と回答																		
男性	0	0.0%	0	0.0%	1	16.7%	3	20.0%	0	0.0%	4	21.1%	1	3.7%	1	1.3%	10	6.3%
女性	1	12.5%	4	66.7%	2	33.3%	6	33.3%	1	5.9%	1	5.6%	1	4.3%	2	3.2%	18	11.3%
男女合計	1	7.7%	4	50.0%	3	25.0%	9	27.3%	1	3.8%	5	13.5%	2	4.0%	3	2.1%	28	8.8%
無回答																		
男性	0	0.0%	0	0.0%	0	0.0%	0	0.0%	0	0.0%	0	0.0%	0	0.0%	1	1.3%	1	0.6%
女性	0	0.0%	0	0.0%	0	0.0%	0	0.0%	0	0.0%	0	0.0%	0	0.0%	1	1.6%	1	0.6%
男女合計	0	0.0%	0	0.0%	0	0.0%	0	0.0%	0	0.0%	0	0.0%	0	0.0%	2	1.4%	2	0.6%
全体(人)																		
男性	5		2		6		15		9		19		27		77		160	
女性	8		6		6		18		17		18		23		63		159	
男女合計	13		8		12		33		26		37		50		140		319	

いわき

	10	割合	20	割合	30	割合	40	割合	50	割合	64	割合	69	割合	70～	割合	全体数	割合
1と回答																		
男性	16	84.2%	14	60.9%	31	60.8%	49	81.7%	56	82.4%	30	85.7%	35	92.1%	132	96.4%	363	84.2%
女性	13	86.7%	22	71.0%	34	75.6%	54	88.5%	58	92.1%	35	85.4%	44	89.8%	151	96.2%	411	89.0%
男女合計	29	85.3%	36	66.7%	65	67.7%	103	85.1%	114	87.0%	65	85.5%	79	90.8%	283	96.3%	774	86.7%
2と回答																		
男性	3	15.8%	9	39.1%	20	39.2%	11	18.3%	11	16.2%	5	14.3%	3	7.9%	0	0.0%	62	14.4%
女性	1	6.7%	9	29.0%	11	24.4%	7	11.5%	5	7.9%	6	14.6%	5	10.2%	5	3.2%	49	10.6%
男女合計	4	11.8%	18	33.3%	31	32.3%	18	14.9%	16	12.2%	11	14.5%	8	9.2%	5	1.7%	111	12.4%
無回答																		
男性	0	0.0%	0	0.0%	0	0.0%	0	0.0%	1	1.5%	0	0.0%	0	0.0%	5	3.6%	6	1.4%
女性	1	6.7%	0	0.0%	0	0.0%	0	0.0%	0	0.0%	0	0.0%	0	0.0%	1	0.6%	2	0.4%
男女合計	1	2.9%	0	0.0%	0	0.0%	0	0.0%	1	0.8%	0	0.0%	0	0.0%	6	2.0%	8	0.9%
全体(人)																		
男性	19		23		51		60		68		35		38		137		431	
女性	15		31		45		61		63		41		49		157		462	
男女合計	34		54		96		121		131		76		87		294		893	

全県(60歳以上・再掲)

	64	割合	69	割合	70	割合	80	割合	90	割合	全体数	割合
1と回答												
男性	223	84.8%	263	92.3%	475	95.6%	257	94.8%	36	94.7%	1254	92.6%
女性	230	88.5%	287	93.8%	494	97.1%	300	92.9%	78	94.0%	1389	93.8%
男女合計	453	86.6%	550	93.1%	969	96.3%	557	93.8%	114	94.2%	2643	93.2%
2と回答												
男性	40	15.2%	18	6.3%	17	3.4%	8	3.0%	2	5.3%	85	6.3%
女性	29	11.2%	17	5.6%	13	2.6%	18	5.6%	2	2.4%	79	5.3%
男女合計	69	13.2%	35	5.9%	30	3.0%	26	4.4%	4	3.3%	164	5.8%
無回答												
男性	0	0.0%	4	1.4%	5	1.0%	6	2.2%	0	0.0%	15	1.1%
女性	1	0.4%	2	0.7%	2	0.4%	5	1.5%	3	3.6%	13	0.9%
男女合計	1	0.2%	6	1.0%	7	0.7%	11	1.9%	3	2.5%	28	1.0%
全体(人)												
男性	263		285		497		271		38		1354	
女性	260		306		509		323		83		1481	
男女合計	523		591		1006		594		121		2835	

5 食生活（朝食・夕食）の状況（調査票 問5）

問5 あなたは、朝食を家族とどのくらい一緒に食べていますか。（あてはまる番号1つに○）

- 1 ほとんど毎日 2 週に4～5日 3 週に2～3日
4 週に1日程度 5 ほとんどない

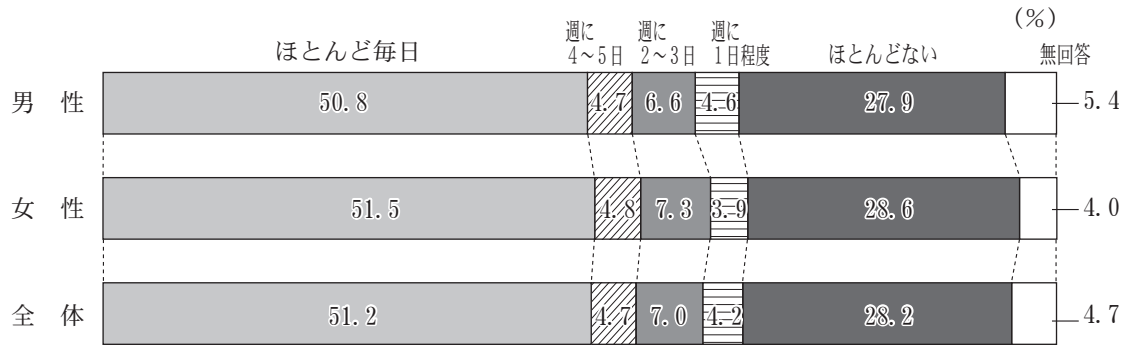

	10	割合	20	割合	30	割合	40	割合	50	割合	64	割合	69	割合	70	割合	80	割合	90	割合	全体数	割合
1と回答																						
男性	51	42.9%	36	21.7%	92	36.7%	134	35.8%	154	39.3%	131	49.8%	177	62.1%	352	70.8%	195	72.0%	28	73.7%	1350	50.8%
女性	52	41.9%	59	33.0%	116	47.2%	167	49.1%	196	44.4%	142	54.6%	190	62.1%	321	63.1%	164	50.8%	40	48.2%	1447	51.5%
男女合計	103	42.4%	95	27.5%	208	41.9%	301	42.2%	350	42.0%	273	52.2%	367	62.1%	673	66.9%	359	60.4%	68	56.2%	2797	51.2%
2と回答																						
男性	8	6.7%	13	7.8%	19	7.6%	20	5.3%	15	3.8%	10	3.8%	14	4.9%	18	3.6%	6	2.2%	1	2.6%	124	4.7%
女性	11	8.9%	14	7.8%	16	6.5%	27	7.9%	22	5.0%	9	3.5%	14	4.6%	14	2.8%	6	1.9%	2	2.4%	135	4.8%
男女合計	19	7.8%	27	7.8%	35	7.0%	47	6.6%	37	4.4%	19	3.6%	28	4.7%	32	3.2%	12	2.0%	3	2.5%	259	4.7%
3と回答																						
男性	6	5.0%	14	8.4%	26	10.4%	40	10.7%	34	8.7%	17	6.5%	14	4.9%	19	3.8%	5	1.8%	1	2.6%	176	6.6%
女性	11	8.9%	15	8.4%	24	9.8%	44	12.9%	41	9.3%	24	9.2%	9	2.9%	21	4.1%	12	3.7%	3	3.6%	204	7.3%
男女合計	17	7.0%	29	8.4%	50	10.1%	84	11.8%	75	9.0%	41	7.8%	23	3.9%	40	4.0%	17	2.9%	4	3.3%	380	7.0%
4と回答																						
男性	6	5.0%	8	4.8%	15	6.0%	36	9.6%	25	6.4%	11	4.2%	8	2.8%	8	1.6%	5	1.8%	0	0.0%	122	4.6%
女性	8	6.5%	9	5.0%	15	6.1%	19	5.6%	27	6.1%	9	3.5%	6	2.0%	7	1.4%	7	2.2%	2	2.4%	109	3.9%
男女合計	14	5.8%	17	4.9%	30	6.0%	55	7.7%	52	6.2%	20	3.8%	14	2.4%	15	1.5%	12	2.0%	2	1.7%	231	4.2%
5と回答																						
男性	41	34.5%	83	50.0%	79	31.5%	111	29.7%	135	34.4%	82	31.2%	67	23.5%	88	17.7%	48	17.7%	7	18.4%	741	27.9%
女性	39	31.5%	78	43.6%	64	26.0%	69	20.3%	139	31.5%	70	26.9%	72	23.5%	129	25.3%	114	35.3%	29	34.9%	803	28.6%
男女合計	80	32.9%	161	46.7%	143	28.8%	180	25.2%	274	32.9%	152	29.1%	139	23.5%	217	21.6%	162	27.3%	36	29.8%	1544	28.2%
無回答																						
男性	7	5.9%	12	7.2%	20	8.0%	33	8.8%	29	7.4%	12	4.6%	5	1.8%	12	2.4%	12	4.4%	1	2.6%	143	5.4%
女性	3	2.4%	4	2.2%	11	4.5%	14	4.1%	16	3.6%	6	2.3%	15	4.9%	17	3.3%	20	6.2%	7	8.4%	113	4.0%
男女合計	10	4.1%	16	4.6%	31	6.2%	47	6.6%	45	5.4%	18	3.4%	20	3.4%	29	2.9%	32	5.4%	8	6.6%	256	4.7%
全体(人)																						
男性	119		166		251		374		392		263		285		497		271		38	2656		
女性	124		179		246		340		441		260		306		509		323		83	2811		
男女合計	243		345		497		714		833		523		591		1006		594		121	5467		

県 北

	10	割合	20	割合	30	割合	40	割合	50	割合	64	割合	69	割合	70～	割合	全体数	割合
1と回答																		
男性	14	40.0%	10	20.8%	32	34.8%	50	39.1%	44	37.3%	28	45.2%	33	55.9%	131	68.9%	342	46.7%
女性	16	43.2%	12	23.5%	38	43.2%	55	53.4%	53	39.3%	35	55.6%	59	72.0%	127	54.5%	395	49.9%
男女合計	30	41.7%	22	22.2%	70	38.9%	105	45.5%	97	38.3%	63	50.4%	92	65.2%	258	61.0%	737	48.4%
2と回答																		
男性	2	5.7%	4	8.3%	8	8.7%	9	7.0%	5	4.2%	4	6.5%	3	5.1%	7	3.7%	42	5.7%
女性	4	10.8%	7	13.7%	5	5.7%	6	5.8%	7	5.2%	3	4.8%	1	1.2%	11	4.7%	44	5.6%
男女合計	6	8.3%	11	11.1%	13	7.2%	15	6.5%	12	4.7%	7	5.6%	4	2.8%	18	4.3%	86	5.6%
3と回答																		
男性	3	8.6%	3	6.3%	10	10.9%	12	9.4%	6	5.1%	4	6.5%	3	5.1%	6	3.2%	47	6.4%
女性	2	5.4%	4	7.8%	7	8.0%	10	9.7%	14	10.4%	4	6.3%	1	1.2%	7	3.0%	49	6.2%
男女合計	5	6.9%	7	7.1%	17	9.4%	22	9.5%	20	7.9%	8	6.4%	4	2.8%	13	3.1%	96	6.3%
4と回答																		
男性	4	11.4%	3	6.3%	6	6.5%	7	5.5%	8	6.8%	3	4.8%	3	5.1%	4	2.1%	38	5.2%
女性	1	2.7%	5	9.8%	4	4.5%	1	1.0%	10	7.4%	2	3.2%	2	2.4%	5	2.1%	30	3.8%
男女合計	5	6.9%	8	8.1%	10	5.6%	8	3.5%	18	7.1%	5	4.0%	5	3.5%	9	2.1%	68	4.5%
5と回答																		
男性	10	28.6%	25	52.1%	29	31.5%	36	28.1%	45	38.1%	21	33.9%	16	27.1%	35	18.4%	217	29.6%
女性	12	32.4%	22	43.1%	28	31.8%	24	23.3%	46	34.1%	18	28.6%	13	15.9%	75	32.2%	238	30.1%
男女合計	22	30.6%	47	47.5%	57	31.7%	60	26.0%	91	36.0%	39	31.2%	29	20.6%	110	26.0%	455	29.9%
無回答																		
男性	2	5.7%	3	6.3%	7	7.6%	14	10.9%	10	8.5%	2	3.2%	1	1.7%	7	3.7%	46	6.3%
女性	2	5.4%	1	2.0%	6	6.8%	7	6.8%	5	3.7%	1	1.6%	6	7.3%	8	3.4%	36	4.5%
男女合計	4	5.6%	4	4.0%	13	7.2%	21	9.1%	15	5.9%	3	2.4%	7	5.0%	15	3.5%	82	5.4%
全体(人)																		
男性	35		48		92		128		118		62		59		190		732	
女性	37		51		88		103		135		63		82		233		792	
男女合計	72		99		180		231		253		125		141		423		1524	

県 中

	10	割合	20	割合	30	割合	40	割合	50	割合	64	割合	69	割合	70～	割合	全体数	割合
1と回答																		
男性	14	42.4%	10	25.6%	22	45.8%	25	27.5%	39	35.8%	30	47.6%	47	61.0%	143	72.6%	330	50.2%
女性	12	41.4%	13	25.5%	31	55.4%	37	41.1%	51	49.0%	30	51.7%	40	58.8%	138	60.0%	352	51.3%
男女合計	26	41.9%	23	25.6%	53	51.0%	62	34.3%	90	42.3%	60	49.6%	87	60.0%	281	65.8%	682	50.8%
2と回答																		
男性	4	12.1%	3	7.7%	4	8.3%	8	8.8%	2	1.8%	4	6.3%	4	5.2%	5	2.5%	34	5.2%
女性	3	10.3%	2	3.9%	4	7.1%	13	14.4%	7	6.7%	1	1.7%	3	4.4%	3	1.3%	36	5.2%
男女合計	7	11.3%	5	5.6%	8	7.7%	21	11.6%	9	4.2%	5	4.1%	7	4.8%	8	1.9%	70	5.2%
3と回答																		
男性	3	9.1%	4	10.3%	3	6.3%	12	13.2%	11	10.1%	3	4.8%	2	2.6%	4	2.0%	42	6.4%
女性	2	6.9%	5	9.8%	4	7.1%	16	17.8%	7	6.7%	4	6.9%	3	4.4%	11	4.8%	52	7.6%
男女合計	5	8.1%	9	10.0%	7	6.7%	28	15.5%	18	8.5%	7	5.8%	5	3.4%	15	3.5%	94	7.0%
4と回答																		
男性	2	6.1%	2	5.1%	2	4.2%	11	12.1%	7	6.4%	2	3.2%	2	2.6%	3	1.5%	31	4.7%
女性	3	10.3%	3	5.9%	4	7.1%	6	6.7%	3	2.9%	4	6.9%	0	0.0%	5	2.2%	28	4.1%
男女合計	5	8.1%	5	5.6%	6	5.8%	17	9.4%	10	4.7%	6	5.0%	2	1.4%	8	1.9%	59	4.4%
5と回答																		
男性	9	27.3%	15	38.5%	15	31.3%	24	26.4%	38	34.9%	19	30.2%	20	26.0%	36	18.3%	176	26.8%
女性	9	31.0%	28	54.9%	8	14.3%	15	16.7%	30	28.8%	17	29.3%	21	30.9%	59	25.7%	187	27.3%
男女合計	18	29.0%	43	47.8%	23	22.1%	39	21.5%	68	31.9%	36	29.8%	41	28.3%	95	22.2%	363	27.0%
無回答																		
男性	1	3.0%	5	12.8%	2	4.2%	11	12.1%	12	11.0%	5	7.9%	2	2.6%	6	3.0%	44	6.7%
女性	0	0.0%	0	0.0%	5	8.9%	3	3.3%	6	5.8%	2	3.4%	1	1.5%	14	6.1%	31	4.5%
男女合計	1	1.6%	5	5.6%	7	6.7%	14	7.7%	18	8.5%	7	5.8%	3	2.1%	20	4.7%	75	5.6%
全体(人)																		
男性	33		39		48		91		109		63		77		197		657	
女性	29		51		56		90		104		58		68		230		686	
男女合計	62		90		104		181		213		121		145		427		1343	

県 南

	10	割合	20	割合	30	割合	40	割合	50	割合	64	割合	69	割合	70～	割合	全体数	割合
1と回答																		
男性	3	42.9%	6	26.1%	3	13.6%	14	37.8%	14	41.2%	22	68.8%	25	75.8%	59	69.4%	146	53.5%
女性	8	42.1%	7	41.2%	9	50.0%	14	50.0%	20	43.5%	22	68.8%	19	65.5%	58	59.8%	157	54.9%
男女合計	11	42.3%	13	32.5%	12	30.0%	28	43.1%	34	42.5%	44	68.8%	44	71.0%	117	64.3%	303	54.2%
2と回答																		
男性	0	0.0%	5	21.7%	3	13.6%	1	2.7%	1	2.9%	1	3.1%	1	3.0%	3	3.5%	15	5.5%
女性	0	0.0%	0	0.0%	1	5.6%	2	7.1%	2	4.3%	0	0.0%	1	3.4%	1	1.0%	7	2.4%
男女合計	0	0.0%	5	12.5%	4	10.0%	3	4.6%	3	3.8%	1	1.6%	2	3.2%	4	2.2%	22	3.9%
3と回答																		
男性	0	0.0%	2	8.7%	3	13.6%	3	8.1%	2	5.9%	1	3.1%	2	6.1%	5	5.9%	18	6.6%
女性	4	21.1%	1	5.9%	2	11.1%	2	7.1%	6	13.0%	3	9.4%	2	6.9%	5	5.2%	25	8.7%
男女合計	4	15.4%	3	7.5%	5	12.5%	5	7.7%	8	10.0%	4	6.3%	4	6.5%	10	5.5%	43	7.7%
4と回答																		
男性	0	0.0%	1	4.3%	3	13.6%	5	13.5%	4	11.8%	3	9.4%	0	0.0%	0	0.0%	16	5.9%
女性	1	5.3%	0	0.0%	0	0.0%	4	14.3%	4	8.7%	1	3.1%	0	0.0%	0	0.0%	10	3.5%
男女合計	1	3.8%	1	2.5%	3	7.5%	9	13.8%	8	10.0%	4	6.3%	0	0.0%	0	0.0%	26	4.7%
5と回答																		
男性	3	42.9%	7	30.4%	7	31.8%	13	35.1%	11	32.4%	4	12.5%	5	15.2%	14	16.5%	64	23.4%
女性	6	31.6%	8	47.1%	6	33.3%	6	21.4%	13	28.3%	5	15.6%	7	24.1%	26	26.8%	77	26.9%
男女合計	9	34.6%	15	37.5%	13	32.5%	19	29.2%	24	30.0%	9	14.1%	12	19.4%	40	22.0%	141	25.2%
無回答																		
男性	1	14.3%	2	8.7%	3	13.6%	1	2.7%	2	5.9%	1	3.1%	0	0.0%	4	4.7%	14	5.1%
女性	0	0.0%	1	5.9%	0													

会 津

	10	割合	20	割合	30	割合	40	割合	50	割合	64	割合	69	割合	70～	割合	全体数	割合
1と回答																		
男性	11	55.0%	6	21.4%	13	44.8%	8	23.5%	18	38.3%	30	60.0%	26	57.8%	75	76.5%	187	53.3%
女性	6	42.9%	11	52.4%	13	40.6%	20	58.8%	35	48.6%	25	58.1%	28	58.3%	67	58.3%	205	54.1%
男女合計	17	50.0%	17	34.7%	26	42.6%	28	41.2%	53	44.5%	55	59.1%	54	58.1%	142	66.7%	392	53.7%
2と回答																		
男性	0	0.0%	1	3.6%	1	3.4%	1	2.9%	4	8.5%	1	2.0%	4	8.9%	1	1.0%	13	3.7%
女性	1	7.1%	1	4.8%	3	9.4%	1	2.9%	3	4.2%	3	7.0%	3	6.3%	1	0.9%	16	4.2%
男女合計	1	2.9%	2	4.1%	4	6.6%	2	2.9%	7	5.9%	4	4.3%	7	7.5%	2	0.9%	29	4.0%
3と回答																		
男性	0	0.0%	2	7.1%	2	6.9%	7	20.6%	5	10.6%	4	8.0%	3	6.7%	2	2.0%	25	7.1%
女性	2	14.3%	1	4.8%	4	12.5%	5	14.7%	6	8.3%	3	7.0%	1	2.1%	3	2.6%	25	6.6%
男女合計	2	5.9%	3	6.1%	6	9.8%	12	17.6%	11	9.2%	7	7.5%	4	4.3%	5	2.3%	50	6.8%
4と回答																		
男性	0	0.0%	1	3.6%	1	3.4%	4	11.8%	3	6.4%	2	4.0%	2	4.4%	1	1.0%	14	4.0%
女性	2	14.3%	1	4.8%	2	6.3%	1	2.9%	3	4.2%	1	2.3%	1	2.1%	0	0.0%	11	2.9%
男女合計	2	5.9%	2	4.1%	3	4.9%	5	7.4%	6	5.0%	3	3.2%	3	3.2%	1	0.5%	25	3.4%
5と回答																		
男性	9	45.0%	17	60.7%	10	34.5%	11	32.4%	16	34.0%	12	24.0%	9	20.0%	17	17.3%	101	28.8%
女性	3	21.4%	6	28.6%	10	31.3%	6	17.6%	24	33.3%	9	20.9%	13	27.1%	36	31.3%	107	28.2%
男女合計	12	35.3%	23	46.9%	20	32.8%	17	25.0%	40	33.6%	21	22.6%	22	23.7%	53	24.9%	208	28.5%
無回答																		
男性	0	0.0%	1	3.6%	2	6.9%	3	8.8%	1	2.1%	1	2.0%	1	2.2%	2	2.0%	11	3.1%
女性	0	0.0%	1	4.8%	0	0.0%	1	2.9%	1	1.4%	2	4.7%	2	4.2%	8	7.0%	15	4.0%
男女合計	0	0.0%	2	4.1%	2	3.3%	4	5.9%	2	1.7%	3	3.2%	3	3.2%	10	4.7%	26	3.6%
全体(人)																		
男性	20		28		29		34		47		50		45		98		351	
女性	14		21		32		34		72		43		48		115		379	
男女合計	34		49		61		68		119		93		93		213		730	

南 会 津

	10	割合	20	割合	30	割合	40	割合	50	割合	64	割合	69	割合	70～	割合	全体数	割合
1と回答																		
男性	0	0.0%	0	0.0%	1	33.3%	5	55.6%	6	85.7%	0	0.0%	3	50.0%	15	68.2%	30	57.7%
女性	0	0.0%	1	50.0%	0	0.0%	4	66.7%	0	0.0%	3	60.0%	3	42.9%	12	60.0%	23	48.9%
男女合計	0	0.0%	1	20.0%	1	25.0%	9	60.0%	6	54.5%	3	42.9%	6	46.2%	27	64.3%	53	53.5%
2と回答																		
男性	0	0.0%	0	0.0%	0	0.0%	0	0.0%	0	0.0%	0	0.0%	1	16.7%	2	9.1%	3	5.8%
女性	0	0.0%	0	0.0%	0	0.0%	0	0.0%	0	0.0%	0	0.0%	1	14.3%	1	5.0%	2	4.3%
男女合計	0	0.0%	0	0.0%	0	0.0%	0	0.0%	0	0.0%	0	0.0%	2	15.4%	3	7.1%	5	5.1%
3と回答																		
男性	0	0.0%	0	0.0%	0	0.0%	0	0.0%	1	14.3%	0	0.0%	0	0.0%	0	0.0%	1	1.9%
女性	0	0.0%	0	0.0%	0	0.0%	0	0.0%	0	0.0%	1	20.0%	0	0.0%	0	0.0%	1	2.1%
男女合計	0	0.0%	0	0.0%	0	0.0%	0	0.0%	1	9.1%	1	14.3%	0	0.0%	0	0.0%	2	2.0%
4と回答																		
男性	0	0.0%	0	0.0%	0	0.0%	1	11.1%	0	0.0%	0	0.0%	0	0.0%	0	0.0%	1	1.9%
女性	0	0.0%	0	0.0%	0	0.0%	1	16.7%	2	50.0%	0	0.0%	1	14.3%	1	5.0%	5	10.6%
男女合計	0	0.0%	0	0.0%	0	0.0%	2	13.3%	2	18.2%	0	0.0%	1	7.7%	1	2.4%	6	6.1%
5と回答																		
男性	0	0.0%	3	100.0%	1	33.3%	3	33.3%	0	0.0%	2	100.0%	2	33.3%	5	22.7%	16	30.8%
女性	1	50.0%	1	50.0%	1	100.0%	0	0.0%	2	50.0%	1	20.0%	2	28.6%	6	30.0%	14	29.8%
男女合計	1	50.0%	4	80.0%	2	50.0%	3	20.0%	2	18.2%	3	42.9%	4	30.8%	11	26.2%	30	30.3%
無回答																		
男性	0	0.0%	0	0.0%	1	33.3%	0	0.0%	0	0.0%	0	0.0%	0	0.0%	0	0.0%	1	1.9%
女性	1	50.0%	0	0.0%	0	0.0%	1	16.7%	0	0.0%	0	0.0%	0	0.0%	0	0.0%	2	4.3%
男女合計	1	50.0%	0	0.0%	1	25.0%	1	6.7%	0	0.0%	0	0.0%	0	0.0%	0	0.0%	3	3.0%
全体(人)																		
男性	0		3		3		9		7		2		6		22		52	
女性	2		2		1		6		4		5		7		20		47	
男女合計	2		5		4		15		11		7		13		42		99	

相 双

	10	割合	20	割合	30	割合	40	割合	50	割合	64	割合	69	割合	70～	割合	全体数	割合
1と回答																		
男性	1	20.0%	1	50.0%	5	83.3%	7	46.7%	6	66.7%	9	47.4%	20	74.1%	59	76.6%	108	67.5%
女性	3	37.5%	1	16.7%	2	33.3%	7	38.9%	11	64.7%	10	55.6%	18	78.3%	40	63.5%	92	57.9%
男女合計	4	30.8%	2	25.0%	7	58.3%	14	42.4%	17	65.4%	19	51.4%	38	76.0%	99	70.7%	200	62.7%
2と回答																		
男性	0	0.0%	0	0.0%	0	0.0%	0	0.0%	0	0.0%	0	0.0%	0	0.0%	1	1.3%	1	0.6%
女性	1	12.5%	1	16.7%	0	0.0%	0	0.0%	1	5.9%	0	0.0%	3	13.0%	0	0.0%	6	3.8%
男女合計	1	7.7%	1	12.5%	0	0.0%	0	0.0%	1	3.8%	0	0.0%	3	6.0%	1	0.7%	7	2.2%
3と回答																		
男性	0	0.0%	0	0.0%	0	0.0%	0	0.0%	1	11.1%	2	10.5%	0	0.0%	2	2.6%	5	3.1%
女性	0	0.0%	1	16.7%	4	66.7%	3	16.7%	1	5.9%	0	0.0%	0	0.0%	2	3.2%	11	6.9%
男女合計	0	0.0%	1	12.5%	4	33.3%	3	9.1%	2	7.7%	2	5.4%	0	0.0%	4	2.9%	16	5.0%
4と回答																		
男性	0	0.0%	0	0.0%	0	0.0%	3	20.0%	1	11.1%	0	0.0%	1	3.7%	1	1.3%	6	3.8%
女性	0	0.0%	0	0.0%	0	0.0%	4	22.2%	2	11.8%	1	5.6%	0	0.0%	4	6.3%	11	6.9%
男女合計	0	0.0%	0	0.0%	0	0.0%	7	21.2%	3	11.5%	1	2.7%	1	2.0%	5	3.6%	17	5.3%
5と回答																		
男性	4	80.0%	1	50.0%	1	16.7%	4	26.7%	1	11.1%	6	31.6%	6	22.2%	13	16.9%	36	22.5%
女性	4	50.0%	3	50.0%	0	0.0%	4	22.2%	2	11.8%	7	38.9%	2	8.7%	14	22.2%	36	22.6%
男女合計	8	61.5%	4	50.0%	1	8.3%	8	24.2%	3	11.5%	13	35.1%	8	16.0%	27	19.3%	72	22.6%
無回答																		
男性	0	0.0%	0	0.0%	0	0.0%	1	6.7%	0	0.0%	2	10.5%	0	0.0%	1	1.3%	4	2.5%
女性	0	0.0%	0	0.0%	0	0.0%	0	0.0%	0	0.0%	0	0.0%	0	0.0%	3	4.8%	3	1.9%
男女合計	0	0.0%	0	0.0%	0	0.0%	1	3.0%	0									

いわき

	10	割合	20	割合	30	割合	40	割合	50	割合	64	割合	69	割合	70～	割合	全体数	割合
1と回答																		
男性	8	42.1%	3	13.0%	16	31.4%	25	41.7%	27	39.7%	12	34.3%	23	60.5%	93	67.9%	207	48.0%
女性	7	46.7%	14	45.2%	23	51.1%	30	49.2%	26	41.3%	17	41.5%	23	46.9%	83	52.9%	223	48.3%
男女合計	15	44.1%	17	31.5%	39	40.6%	55	45.5%	53	40.5%	29	38.2%	46	52.9%	176	59.9%	430	48.2%
2と回答																		
男性	2	10.5%	0	0.0%	3	5.9%	1	1.7%	3	4.4%	0	0.0%	1	2.6%	6	4.4%	16	3.7%
女性	2	13.3%	3	9.7%	3	6.7%	5	8.2%	2	3.2%	2	4.9%	2	4.1%	5	3.2%	24	5.2%
男女合計	4	11.8%	3	5.6%	6	6.3%	6	5.0%	5	3.8%	2	2.6%	3	3.4%	11	3.7%	40	4.5%
3と回答																		
男性	0	0.0%	3	13.0%	8	15.7%	6	10.0%	8	11.8%	3	8.6%	4	10.5%	6	4.4%	38	8.8%
女性	1	6.7%	3	9.7%	3	6.7%	8	13.1%	7	11.1%	9	22.0%	2	4.1%	8	5.1%	41	8.9%
男女合計	1	2.9%	6	11.1%	11	11.5%	14	11.6%	15	11.5%	12	15.8%	6	6.9%	14	4.8%	79	8.8%
4と回答																		
男性	0	0.0%	1	4.3%	3	5.9%	5	8.3%	2	2.9%	1	2.9%	0	0.0%	4	2.9%	16	3.7%
女性	1	6.7%	0	0.0%	5	11.1%	2	3.3%	3	4.8%	0	0.0%	2	4.1%	1	0.6%	14	3.0%
男女合計	1	2.9%	1	1.9%	8	8.3%	7	5.8%	5	3.8%	1	1.3%	2	2.3%	5	1.7%	30	3.4%
5と回答																		
男性	6	31.6%	15	65.2%	16	31.4%	20	33.3%	24	35.3%	18	51.4%	9	23.7%	23	16.8%	131	30.4%
女性	4	26.7%	10	32.3%	11	24.4%	14	23.0%	22	34.9%	13	31.7%	14	28.6%	56	35.7%	144	31.2%
男女合計	10	29.4%	25	46.3%	27	28.1%	34	28.1%	46	35.1%	31	40.8%	23	26.4%	79	26.9%	275	30.8%
無回答																		
男性	3	15.8%	1	4.3%	5	9.8%	3	5.0%	4	5.9%	1	2.9%	1	2.6%	5	3.6%	23	5.3%
女性	0	0.0%	1	3.2%	0	0.0%	2	3.3%	3	4.8%	0	0.0%	6	12.2%	4	2.5%	16	3.5%
男女合計	3	8.8%	2	3.7%	5	5.2%	5	4.1%	7	5.3%	1	1.3%	7	8.0%	9	3.1%	39	4.4%
全体(人)																		
男性	19		23		51		60		68		35		38		137		431	
女性	15		31		45		61		63		41		49		157		462	
男女合計	34		54		96		121		131		76		87		294		893	

全県 (60歳以上・再掲)

	64	割合	69	割合	70	割合	80	割合	90	割合	全体数	割合
1と回答												
男性	131	49.8%	177	62.1%	352	70.8%	195	72.0%	28	73.7%	883	65.2%
女性	142	54.6%	190	62.1%	321	63.1%	164	50.8%	40	48.2%	857	57.9%
男女合計	273	52.2%	367	62.1%	673	66.9%	359	60.4%	68	56.2%	1740	61.4%
2と回答												
男性	10	3.8%	14	4.9%	18	3.6%	6	2.2%	1	2.6%	49	3.6%
女性	9	3.5%	14	4.6%	14	2.8%	6	1.9%	2	2.4%	45	3.0%
男女合計	19	3.6%	28	4.7%	32	3.2%	12	2.0%	3	2.5%	94	3.3%
3と回答												
男性	17	6.5%	14	4.9%	19	3.8%	5	1.8%	1	2.6%	56	4.1%
女性	24	9.2%	9	2.9%	21	4.1%	12	3.7%	3	3.6%	69	4.7%
男女合計	41	7.8%	23	3.9%	40	4.0%	17	2.9%	4	3.3%	125	4.4%
4と回答												
男性	11	4.2%	8	2.8%	8	1.6%	5	1.8%	0	0.0%	32	2.4%
女性	9	3.5%	6	2.0%	7	1.4%	7	2.2%	2	2.4%	31	2.1%
男女合計	20	3.8%	14	2.4%	15	1.5%	12	2.0%	2	1.7%	63	2.2%
5と回答												
男性	82	31.2%	67	23.5%	88	17.7%	48	17.7%	7	18.4%	292	21.6%
女性	70	26.9%	72	23.5%	129	25.3%	114	35.3%	29	34.9%	414	28.0%
男女合計	152	29.1%	139	23.5%	217	21.6%	162	27.3%	36	29.8%	706	24.9%
無回答												
男性	12	4.6%	5	1.8%	12	2.4%	12	4.4%	1	2.6%	42	3.1%
女性	6	2.3%	15	4.9%	17	3.3%	20	6.2%	7	8.4%	65	4.4%
男女合計	18	3.4%	20	3.4%	29	2.9%	32	5.4%	8	6.6%	107	3.8%
全体(人)												
男性	263		285		497		271		38		1354	
女性	260		306		509		323		83		1481	
男女合計	523		591		1006		594		121		2835	

5 食生活（朝食・夕食）の状況（調査票 問5）

問5 あなたは、夕食を家族とどのくらい一緒に食べていますか。（あてはまる番号1つに○）

- 1 ほとんど毎日 2 週に4～5日 3 週に2～3日
4 週に1日程度 5 ほとんどない

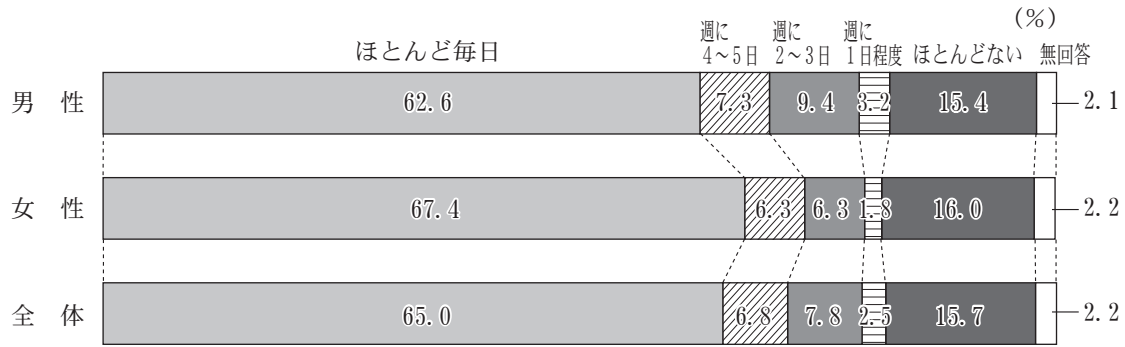

	10	割合	20	割合	30	割合	40	割合	50	割合	64	割合	69	割合	70	割合	80	割合	90	割合	全体数	割合
1と回答																						
男性	70	58.8%	66	39.8%	115	45.8%	202	54.0%	217	55.4%	174	66.2%	204	71.6%	376	75.7%	208	76.8%	30	78.9%	1662	62.6%
女性	82	66.1%	96	53.6%	186	75.6%	254	74.7%	288	65.3%	187	71.9%	229	74.8%	348	68.4%	181	56.0%	43	51.8%	1894	67.4%
男女合計	152	62.6%	162	47.0%	301	60.6%	456	63.9%	505	60.6%	361	69.0%	433	73.3%	724	72.0%	389	65.5%	73	60.3%	3556	65.0%
2と回答																						
男性	11	9.2%	23	13.9%	34	13.5%	27	7.2%	38	9.7%	19	7.2%	15	5.3%	20	4.0%	6	2.2%	1	2.6%	194	7.3%
女性	13	10.5%	17	9.5%	14	5.7%	31	9.1%	39	8.8%	11	4.2%	21	6.9%	25	4.9%	5	1.5%	2	2.4%	178	6.3%
男女合計	24	9.9%	40	11.6%	48	9.7%	58	8.1%	77	9.2%	30	5.7%	36	6.1%	45	4.5%	11	1.9%	3	2.5%	372	6.8%
3と回答																						
男性	14	11.8%	22	13.3%	45	17.9%	76	20.3%	50	12.8%	15	5.7%	10	3.5%	12	2.4%	6	2.2%	0	0.0%	250	9.4%
女性	13	10.5%	24	13.4%	15	6.1%	24	7.1%	42	9.5%	22	8.5%	6	2.0%	15	2.9%	11	3.4%	4	4.8%	176	6.3%
男女合計	27	11.1%	46	13.3%	60	12.1%	100	14.0%	92	11.0%	37	7.1%	16	2.7%	27	2.7%	17	2.9%	4	3.3%	426	7.8%
4と回答																						
男性	3	2.5%	9	5.4%	12	4.8%	20	5.3%	17	4.3%	9	3.4%	8	2.8%	6	1.2%	1	0.4%	1	2.6%	86	3.2%
女性	1	0.8%	6	3.4%	10	4.1%	4	1.2%	9	2.0%	5	1.9%	1	0.3%	8	1.6%	4	1.2%	2	2.4%	50	1.8%
男女合計	4	1.6%	15	4.3%	22	4.4%	24	3.4%	26	3.1%	14	2.7%	9	1.5%	14	1.4%	5	0.8%	3	2.5%	136	2.5%
5と回答																						
男性	19	16.0%	44	26.5%	38	15.1%	44	11.8%	69	17.6%	40	15.2%	45	15.8%	66	13.3%	39	14.4%	5	13.2%	409	15.4%
女性	14	11.3%	35	19.6%	19	7.7%	24	7.1%	59	13.4%	34	13.1%	45	14.7%	97	19.1%	99	30.7%	24	28.9%	450	16.0%
男女合計	33	13.6%	79	22.9%	57	11.5%	68	9.5%	128	15.4%	74	14.1%	90	15.2%	163	16.2%	138	23.2%	29	24.0%	859	15.7%
無回答																						
男性	2	1.7%	2	1.2%	7	2.8%	5	1.3%	1	0.3%	6	2.3%	3	1.1%	17	3.4%	11	4.1%	1	2.6%	55	2.1%
女性	1	0.8%	1	0.6%	2	0.8%	3	0.9%	4	0.9%	1	0.4%	4	1.3%	16	3.1%	23	7.1%	8	9.6%	63	2.2%
男女合計	3	1.2%	3	0.9%	9	1.8%	8	1.1%	5	0.6%	7	1.3%	7	1.2%	33	3.3%	34	5.7%	9	7.4%	118	2.2%
全体(人)																						
男性	119		166		251		374		392		263		285		497		271		38	2656		
女性	124		179		246		340		441		260		306		509		323		83	2811		
男女合計	243		345		497		714		833		523		591		1006		594		121	5467		

県北

	10	割合	20	割合	30	割合	40	割合	50	割合	64	割合	69	割合	70～	割合	全体数	割合
1と回答																		
男性	21	60.0%	18	37.5%	39	42.4%	64	50.0%	63	53.4%	44	71.0%	47	79.7%	146	76.8%	442	60.4%
女性	19	51.4%	24	47.1%	62	70.5%	75	72.8%	83	61.5%	48	76.2%	66	80.5%	141	60.5%	518	65.4%
男女合計	40	55.6%	42	42.4%	101	56.1%	139	60.2%	146	57.7%	92	73.6%	113	80.1%	287	67.8%	960	63.0%
2と回答																		
男性	3	8.6%	6	12.5%	15	16.3%	11	8.6%	12	10.2%	6	9.7%	1	1.7%	7	3.7%	61	8.3%
女性	6	16.2%	9	17.6%	7	8.0%	10	9.7%	14	10.4%	1	1.6%	6	7.3%	15	6.4%	68	8.6%
男女合計	9	12.5%	15	15.2%	22	12.2%	21	9.1%	26	10.3%	7	5.6%	7	5.0%	22	5.2%	129	8.5%
3と回答																		
男性	2	5.7%	4	8.3%	16	17.4%	29	22.7%	16	13.6%	4	6.5%	1	1.7%	7	3.7%	79	10.8%
女性	6	16.2%	5	9.8%	7	8.0%	10	9.7%	13	9.6%	5	7.9%	1	1.2%	4	1.7%	51	6.4%
男女合計	8	11.1%	9	9.1%	23	12.8%	39	16.9%	29	11.5%	9	7.2%	2	1.4%	11	2.6%	130	8.5%
4と回答																		
男性	3	8.6%	3	6.3%	6	6.5%	6	4.7%	4	3.4%	2	3.2%	0	0.0%	1	0.5%	25	3.4%
女性	0	0.0%	2	3.9%	3	3.4%	0	0.0%	2	1.5%	0	0.0%	0	0.0%	6	2.6%	13	1.6%
男女合計	3	4.2%	5	5.1%	9	5.0%	6	2.6%	6	2.4%	2	1.6%	0	0.0%	7	1.7%	38	2.5%
5と回答																		
男性	6	17.1%	15	31.3%	15	16.3%	14	10.9%	23	19.5%	5	8.1%	10	16.9%	22	11.6%	110	15.0%
女性	6	16.2%	10	19.6%	7	8.0%	8	7.8%	22	16.3%	9	14.3%	8	9.8%	57	24.5%	127	16.0%
男女合計	12	16.7%	25	25.3%	22	12.2%	22	9.5%	45	17.8%	14	11.2%	18	12.8%	79	18.7%	237	15.6%
無回答																		
男性	0	0.0%	2	4.2%	1	1.1%	4	3.1%	0	0.0%	1	1.6%	0	0.0%	7	3.7%	15	2.0%
女性	0	0.0%	1	2.0%	2	2.3%	0	0.0%	1	0.7%	0	0.0%	1	1.2%	10	4.3%	15	1.9%
男女合計	0	0.0%	3	3.0%	3	1.7%	4	1.7%	1	0.4%	1	0.8%	1	0.7%	17	4.0%	30	2.0%
全体(人)																		
男性	35		48		92		128		118		62		59		190		732	
女性	37		51		88		103		135		63		82		233		792	
男女合計	72		99		180		231		253		125		141		423		1524	

県中

	10	割合	20	割合	30	割合	40	割合	50	割合	64	割合	69	割合	70～	割合	全体数	割合
1と回答																		
男性	13	39.4%	20	51.3%	16	33.3%	44	48.4%	52	47.7%	39	61.9%	48	62.3%	153	77.7%	385	58.6%
女性	20	69.0%	26	51.0%	46	82.1%	63	70.0%	66	63.5%	33	56.9%	45	66.2%	140	60.9%	439	64.0%
男女合計	33	53.2%	46	51.1%	62	59.6%	107	59.1%	118	55.4%	72	59.5%	93	64.1%	293	68.6%	824	61.4%
2と回答																		
男性	7	21.2%	4	10.3%	7	14.6%	7	7.7%	11	10.1%	2	3.2%	6	7.8%	6	3.0%	50	7.6%
女性	3	10.3%	3	5.9%	2	3.6%	11	12.2%	10	9.6%	4	6.9%	4	5.9%	7	3.0%	44	6.4%
男女合計	10	16.1%	7	7.8%	9	8.7%	18	9.9%	21	9.9%	6	5.0%	10	6.9%	13	3.0%	94	7.0%
3と回答																		
男性	7	21.2%	5	12.8%	12	25.0%	21	23.1%	13	11.9%	3	4.8%	3	3.9%	1	0.5%	65	9.9%
女性	2	6.9%	10	19.6%	4	7.1%	8	8.9%	6	5.8%	10	17.2%	1	1.5%	14	6.1%	55	8.0%
男女合計	9	14.5%	15	16.7%	16	15.4%	29	16.0%	19	8.9%	13	10.7%	4	2.8%	15	3.5%	120	8.9%
4と回答																		
男性	0	0.0%	3	7.7%	3	6.3%	8	8.8%	6	5.5%	4	6.3%	4	5.2%	3	1.5%	31	4.7%
女性	0	0.0%	2	3.9%	1	1.8%	1	1.1%	2	1.9%	3	5.2%	0	0.0%	4	1.7%	13	1.9%
男女合計	0	0.0%	5	5.6%	4	3.8%	9	5.0%	8	3.8%	7	5.8%	4	2.8%	7	1.6%	44	3.3%
5と回答																		
男性	4	12.1%	7	17.9%	10	20.8%	11	12.1%	27	24.8%	13	20.6%	15	19.5%	29	14.7%	116	17.7%
女性	4	13.8%	10	19.6%	3	5.4%	5	5.6%	18	17.3%	7	12.1%	17	25.0%	51	22.2%	115	16.8%
男女合計	8	12.9%	17	18.9%	13	12.5%	16	8.8%	45	21.1%	20	16.5%	32	22.1%	80	18.7%	231	17.2%
無回答																		
男性	2	6.1%	0	0.0%	0	0.0%	0	0.0%	0	0.0%	2	3.2%	1	1.3%	5	2.5%	10	1.5%
女性	0	0.0%	0	0.0%	0	0.0%	2	2.2%	2	1.9%	1	1.7%	1	1.5%	14	6.1%	20	2.9%
男女合計	2	3.2%	0	0.0%	0	0.0%	2	1.1%	2	0.9%	3	2.5%	2	1.4%	19	4.4%	30	2.2%
全体(人)																		
男性	33		39		48		91		109		63		77		197		657	
女性	29		51		56		90		104		58		68		230		686	
男女合計	62		90		104		181		213		121		145		427		1343	

県南

	10	割合	20	割合	30	割合	40	割合	50	割合	64	割合	69	割合	70～	割合	全体数	割合
1と回答																		
男性	5	71.4%	10	43.5%	9	40.9%	21	56.8%	23	67.6%	22	68.8%	25	75.8%	61	71.8%	176	64.5%
女性	14	73.7%	9	52.9%	16	88.9%	23	82.1%	34	73.9%	28	87.5%	20	69.0%	57	58.8%	201	70.3%
男女合計	19	73.1%	19	47.5%	25	62.5%	44	67.7%	57	71.3%	50	78.1%	45	72.6%	118	64.8%	377	67.4%
2と回答																		
男性	1	14.3%	3	13.0%	5	22.7%	1	2.7%	2	5.9%	2	6.3%	2	6.1%	4	4.7%	20	7.3%
女性	1	5.3%	1	5.9%	1	5.6%	1	3.6%	2	4.3%	1	3.1%	2	6.9%	3	3.1%	12	4.2%
男女合計	2	7.7%	4	10.0%	6	15.0%	2	3.1%	4	5.0%	3	4.7%	4	6.5%	7	3.8%	32	5.7%
3と回答																		
男性	0	0.0%	5	21.7%	2	9.1%	9	24.3%	2	5.9%	2	6.3%	1	3.0%	0	0.0%	21	7.7%
女性	2	10.5%	3	17.6%	0	0.0%	1	3.6%	5	10.9%	1	3.1%	2	6.9%	4	4.1%	18	6.3%
男女合計	2	7.7%	8	20.0%	2	5.0%	10	15.4%	7	8.8%	3	4.7%	3	4.8%	4	2.2%	39	7.0%
4と回答																		
男性	0	0.0%	1	4.3%	1	4.5%	2	5.4%	4	11.8%	1	3.1%	0	0.0%	2	2.4%	11	4.0%
女性	1	5.3%	0	0.0%	1	5.6%	0	0.0%	2	4.3%	1	3.1%	0	0.0%	0	0.0%	5	1.7%
男女合計	1	3.8%	1	2.5%	2	5.0%	2	3.1%	6	7.5%	2	3.1%	0	0.0%	2	1.1%	16	2.9%
5と回答																		
男性	1	14.3%	4	17.4%	2	9.1%	4	10.8%	3	8.8%	4	12.5%	4	12.1%	12	14.1%	34	12.5%
女性	1	5.3%	4	23.5%	0	0.0%	3	10.7%	3	6.5%	1	3.1%	4	13.8%	24	24.7%	40	14.0%
男女合計	2	7.7%	8	20.0%	2	5.0%	7	10.8%	6	7.5%	5	7.8%	8	12.9%	36	19.8%	74	13.2%
無回答																		
男性	0	0.0%	0	0.0%	3	13.6%	0	0.0%	0	0.0%	1	3.1%	1	3.0%	6	7.1%	11	4.0%
女性	0	0.0%	0	0.0%	0	0.0%	0											

いわき

	10	割合	20	割合	30	割合	40	割合	50	割合	64	割合	69	割合	70～	割合	全体数	割合
1と回答																		
男性	11	57.9%	7	30.4%	29	56.9%	35	58.3%	36	52.9%	21	60.0%	28	73.7%	103	75.2%	270	62.6%
女性	11	73.3%	17	54.8%	37	82.2%	43	70.5%	40	63.5%	31	75.6%	35	71.4%	103	65.6%	317	68.6%
男女合計	22	64.7%	24	44.4%	66	68.8%	78	64.5%	76	58.0%	52	68.4%	63	72.4%	206	70.1%	587	65.7%
2と回答																		
男性	0	0.0%	4	17.4%	5	9.8%	3	5.0%	8	11.8%	2	5.7%	1	2.6%	4	2.9%	27	6.3%
女性	1	6.7%	3	9.7%	1	2.2%	7	11.5%	6	9.5%	1	2.4%	4	8.2%	4	2.5%	27	5.8%
男女合計	1	2.9%	7	13.0%	6	6.3%	10	8.3%	14	10.7%	3	3.9%	5	5.7%	8	2.7%	54	6.0%
3と回答																		
男性	3	15.8%	5	21.7%	9	17.6%	11	18.3%	12	17.6%	3	8.6%	4	10.5%	6	4.4%	53	12.3%
女性	3	20.0%	2	6.5%	1	2.2%	2	3.3%	7	11.1%	3	7.3%	1	2.0%	2	1.3%	21	4.5%
男女合計	6	17.6%	7	13.0%	10	10.4%	13	10.7%	19	14.5%	6	7.9%	5	5.7%	8	2.7%	74	8.3%
4と回答																		
男性	0	0.0%	0	0.0%	0	0.0%	3	5.0%	1	1.5%	0	0.0%	0	0.0%	1	0.7%	5	1.2%
女性	0	0.0%	2	6.5%	3	6.7%	1	1.6%	2	3.2%	0	0.0%	0	0.0%	2	1.3%	10	2.2%
男女合計	0	0.0%	2	3.7%	3	3.1%	4	3.3%	3	2.3%	0	0.0%	0	0.0%	3	1.0%	15	1.7%
5と回答																		
男性	5	26.3%	7	30.4%	7	13.7%	8	13.3%	10	14.7%	9	25.7%	5	13.2%	16	11.7%	67	15.5%
女性	0	0.0%	7	22.6%	3	6.7%	7	11.5%	7	11.1%	6	14.6%	8	16.3%	41	26.1%	79	17.1%
男女合計	5	14.7%	14	25.9%	10	10.4%	15	12.4%	17	13.0%	15	19.7%	13	14.9%	57	19.4%	146	16.3%
無回答																		
男性	0	0.0%	0	0.0%	1	2.0%	0	0.0%	1	1.5%	0	0.0%	0	0.0%	7	5.1%	9	2.1%
女性	0	0.0%	0	0.0%	0	0.0%	1	1.6%	1	1.6%	0	0.0%	1	2.0%	5	3.2%	8	1.7%
男女合計	0	0.0%	0	0.0%	1	1.0%	1	0.8%	2	1.5%	0	0.0%	1	1.1%	12	4.1%	17	1.9%
全体(人)																		
男性	19		23		51		60		68		35		38		137		431	
女性	15		31		45		61		63		41		49		157		462	
男女合計	34		54		96		121		131		76		87		294		893	

全県 (60歳以上・再掲)

	64	割合	69	割合	70	割合	80	割合	90	割合	全体数	割合
1と回答												
男性	174	66.2%	204	71.6%	376	75.7%	208	76.8%	30	78.9%	992	73.3%
女性	187	71.9%	229	74.8%	348	68.4%	181	56.0%	43	51.8%	988	66.7%
男女合計	361	69.0%	433	73.3%	724	72.0%	389	65.5%	73	60.3%	1980	69.8%
2と回答												
男性	19	7.2%	15	5.3%	20	4.0%	6	2.2%	1	2.6%	61	4.5%
女性	11	4.2%	21	6.9%	25	4.9%	5	1.5%	2	2.4%	64	4.3%
男女合計	30	5.7%	36	6.1%	45	4.5%	11	1.9%	3	2.5%	125	4.4%
3と回答												
男性	15	5.7%	10	3.5%	12	2.4%	6	2.2%	0	0.0%	43	3.2%
女性	22	8.5%	6	2.0%	15	2.9%	11	3.4%	4	4.8%	58	3.9%
男女合計	37	7.1%	16	2.7%	27	2.7%	17	2.9%	4	3.3%	101	3.6%
4と回答												
男性	9	3.4%	8	2.8%	6	1.2%	1	0.4%	1	2.6%	25	1.8%
女性	5	1.9%	1	0.3%	8	1.6%	4	1.2%	2	2.4%	20	1.4%
男女合計	14	2.7%	9	1.5%	14	1.4%	5	0.8%	3	2.5%	45	1.6%
5と回答												
男性	40	15.2%	45	15.8%	66	13.3%	39	14.4%	5	13.2%	195	14.4%
女性	34	13.1%	45	14.7%	97	19.1%	99	30.7%	24	28.9%	299	20.2%
男女合計	74	14.1%	90	15.2%	163	16.2%	138	23.2%	29	24.0%	494	17.4%
無回答												
男性	6	2.3%	3	1.1%	17	3.4%	11	4.1%	1	2.6%	38	2.8%
女性	1	0.4%	4	1.3%	16	3.1%	23	7.1%	8	9.6%	52	3.5%
男女合計	7	1.3%	7	1.2%	33	3.3%	34	5.7%	9	7.4%	90	3.2%
全体(人)												
男性	263		285		497		271		38		1354	
女性	260		306		509		323		83		1481	
男女合計	523		591		1006		594		121		2835	

6 「食育推進月間」「食育の日」の認知度（調査票 問6）

問6 あなたは、食育推進月間（6月）と食育の日（毎月19日）を知っていますか。（あてはまる番号1つに○）

- 1 知っている 2 名称は知っているが、月日までは知らない
3 知らない

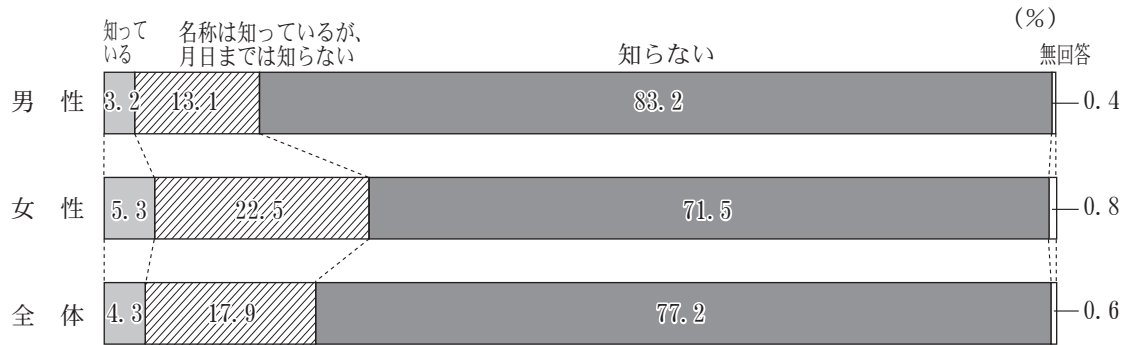

	10	割合	20	割合	30	割合	40	割合	50	割合	64	割合	69	割合	70	割合	80	割合	90	割合	全体数	割合
1と回答																						
男性	5	4.2%	12	7.2%	9	3.6%	14	3.7%	16	4.1%	8	3.0%	6	2.1%	8	1.6%	8	3.0%	0	0.0%	86	3.2%
女性	3	2.4%	12	6.7%	18	7.3%	28	8.2%	32	7.3%	12	4.6%	8	2.6%	23	4.5%	10	3.1%	2	2.4%	148	5.3%
男女合計	8	3.3%	24	7.0%	27	5.4%	42	5.9%	48	5.8%	20	3.8%	14	2.4%	31	3.1%	18	3.0%	2	1.7%	234	4.3%
2と回答																						
男性	11	9.2%	15	9.0%	30	12.0%	36	9.6%	48	12.2%	32	12.2%	32	11.2%	84	16.9%	56	20.7%	5	13.2%	349	13.1%
女性	29	23.4%	19	10.6%	55	22.4%	75	22.1%	100	22.7%	72	27.7%	71	23.2%	128	25.1%	74	22.9%	9	10.8%	632	22.5%
男女合計	40	16.5%	34	9.9%	85	17.1%	111	15.5%	148	17.8%	104	19.9%	103	17.4%	212	21.1%	130	21.9%	14	11.6%	981	17.9%
3と回答																						
男性	103	86.6%	139	83.7%	212	84.5%	322	86.1%	328	83.7%	223	84.8%	246	86.3%	401	80.7%	204	75.3%	33	86.8%	2211	83.2%
女性	92	74.2%	146	81.6%	173	70.3%	237	69.7%	307	69.6%	175	67.3%	224	73.2%	355	69.7%	228	70.6%	72	86.7%	2009	71.5%
男女合計	195	80.2%	285	82.6%	385	77.5%	559	78.3%	635	76.2%	398	76.1%	470	79.5%	756	75.1%	432	72.7%	105	86.8%	4220	77.2%
無回答																						
男性	0	0.0%	0	0.0%	0	0.0%	2	0.5%	0	0.0%	0	0.0%	1	0.4%	4	0.8%	3	1.1%	0	0.0%	10	0.4%
女性	0	0.0%	2	1.1%	0	0.0%	0	0.0%	2	0.5%	1	0.4%	3	1.0%	3	0.6%	11	3.4%	0	0.0%	22	0.8%
男女合計	0	0.0%	2	0.6%	0	0.0%	2	0.3%	2	0.2%	1	0.2%	4	0.7%	7	0.7%	14	2.4%	0	0.0%	32	0.6%
全体(人)																						
男性	119		166		251		374		392		263		285		497		271		38		2656	
女性	124		179		246		340		441		260		306		509		323		83		2811	
男女合計	243		345		497		714		833		523		591		1006		594		121		5467	

県 北

	10	割合	20	割合	30	割合	40	割合	50	割合	64	割合	69	割合	70～	割合	全体数	割合
1と回答																		
男性	0	0.0%	4	8.3%	4	4.3%	3	2.3%	5	4.2%	1	1.6%	1	1.7%	3	1.6%	21	2.9%
女性	0	0.0%	3	5.9%	3	3.4%	7	6.8%	4	3.0%	3	4.8%	1	1.2%	9	3.9%	30	3.8%
男女合計	0	0.0%	7	7.1%	7	3.9%	10	4.3%	9	3.6%	4	3.2%	2	1.4%	12	2.8%	51	3.3%
2と回答																		
男性	3	8.6%	5	10.4%	15	16.3%	9	7.0%	15	12.7%	7	11.3%	7	11.9%	37	19.5%	98	13.4%
女性	9	24.3%	2	3.9%	24	27.3%	18	17.5%	35	25.9%	20	31.7%	15	18.3%	55	23.6%	178	22.5%
男女合計	12	16.7%	7	7.1%	39	21.7%	27	11.7%	50	19.8%	27	21.6%	22	15.6%	92	21.7%	276	18.1%
3と回答																		
男性	32	91.4%	39	81.3%	73	79.3%	115	89.8%	98	83.1%	54	87.1%	50	84.7%	147	77.4%	608	83.1%
女性	28	75.7%	46	90.2%	61	69.3%	78	75.7%	96	71.1%	40	63.5%	65	79.3%	165	70.8%	579	73.1%
男女合計	60	83.3%	85	85.9%	134	74.4%	193	83.5%	194	76.7%	94	75.2%	115	81.6%	312	73.8%	1187	77.9%
無回答																		
男性	0	0.0%	0	0.0%	0	0.0%	1	0.8%	0	0.0%	0	0.0%	1	1.7%	3	1.6%	5	0.7%
女性	0	0.0%	0	0.0%	0	0.0%	0	0.0%	0	0.0%	0	0.0%	1	1.2%	4	1.7%	5	0.6%
男女合計	0	0.0%	0	0.0%	0	0.0%	1	0.4%	0	0.0%	0	0.0%	2	1.4%	7	1.7%	10	0.7%
全体(人)																		
男性	35		48		92		128		118		62		59		190		732	
女性	37		51		88		103		135		63		82		233		792	
男女合計	72		99		180		231		253		125		141		423		1524	

県 中

	10	割合	20	割合	30	割合	40	割合	50	割合	64	割合	69	割合	70～	割合	全体数	割合
1と回答																		
男性	1	3.0%	2	5.1%	1	2.1%	7	7.7%	4	3.7%	2	3.2%	4	5.2%	8	4.1%	29	4.4%
女性	1	3.4%	4	7.8%	4	7.1%	10	11.1%	10	9.6%	3	5.2%	2	2.9%	6	2.6%	40	5.8%
男女合計	2	3.2%	6	6.7%	5	4.8%	17	9.4%	14	6.6%	5	4.1%	6	4.1%	14	3.3%	69	5.1%
2と回答																		
男性	3	9.1%	4	10.3%	3	6.3%	10	11.0%	13	11.9%	6	9.5%	12	15.6%	30	15.2%	81	12.3%
女性	10	34.5%	9	17.6%	10	17.9%	19	21.1%	20	19.2%	14	24.1%	15	22.1%	53	23.0%	150	21.9%
男女合計	13	21.0%	13	14.4%	13	12.5%	29	16.0%	33	15.5%	20	16.5%	27	18.6%	83	19.4%	231	17.2%
3と回答																		
男性	29	87.9%	33	84.6%	44	91.7%	74	81.3%	92	84.4%	55	87.3%	61	79.2%	158	80.2%	546	83.1%
女性	18	62.1%	37	72.5%	42	75.0%	61	67.8%	72	69.2%	41	70.7%	50	73.5%	168	73.0%	489	71.3%
男女合計	47	75.8%	70	77.8%	86	82.7%	135	74.6%	164	77.0%	96	79.3%	111	76.6%	326	76.3%	1035	77.1%
無回答																		
男性	0	0.0%	0	0.0%	0	0.0%	0	0.0%	0	0.0%	0	0.0%	0	0.0%	1	0.5%	1	0.2%
女性	0	0.0%	1	2.0%	0	0.0%	0	0.0%	2	1.9%	0	0.0%	1	1.5%	3	1.3%	7	1.0%
男女合計	0	0.0%	1	1.1%	0	0.0%	0	0.0%	2	0.9%	0	0.0%	1	0.7%	4	0.9%	8	0.6%
全体(人)																		
男性	33		39		48		91		109		63		77		197		657	
女性	29		51		56		90		104		58		68		230		686	
男女合計	62		90		104		181		213		121		145		427		1343	

県 南

	10	割合	20	割合	30	割合	40	割合	50	割合	64	割合	69	割合	70～	割合	全体数	割合
1と回答																		
男性	0	0.0%	2	8.7%	0	0.0%	2	5.4%	2	5.9%	3	9.4%	0	0.0%	3	3.5%	12	4.4%
女性	1	5.3%	2	11.8%	1	5.6%	1	3.6%	3	6.5%	4	12.5%	2	6.9%	4	4.1%	18	6.3%
男女合計	1	3.8%	4	10.0%	1	2.5%	3	4.6%	5	6.3%	7	10.9%	2	3.2%	7	3.8%	30	5.4%
2と回答																		
男性	2	28.6%	2	8.7%	7	31.8%	3	8.1%	8	23.5%	2	6.3%	3	9.1%	21	24.7%	48	17.6%
女性	3	15.8%	3	17.6%	6	33.3%	6	21.4%	14	30.4%	5	15.6%	7	24.1%	16	16.5%	60	21.0%
男女合計	5	19.2%	5	12.5%	13	32.5%	9	13.8%	22	27.5%	7	10.9%	10	16.1%	37	20.3%	108	19.3%
3と回答																		
男性	5	71.4%	19	82.6%	15	68.2%	32	86.5%	24	70.6%	27	84.4%	30	90.9%	60	70.6%	212	77.7%
女性	15	78.9%	12	70.6%	11	61.1%	21	75.0%	29	63.0%	22	68.8%	20	69.0%	74	76.3%	204	71.3%
男女合計	20	76.9%	31	77.5%	26	65.0%	53	81.5%	53	66.3%	49	76.6%	50	80.6%	134	73.6%	416	74.4%
無回答																		
男性	0	0.0%	0	0.0%	0	0.0%	0	0.0%	0	0.0%	0	0.0%	0	0.0%	1	1.2%	1	0.4%
女性	0	0.0%	0	0.0%	0	0.0%	0	0.0%	0	0.0%	1	3.1%	0	0.0%	3	3.1%	4	1.4%
男女合計	0	0.0%	0	0.0%	0	0.0%	0	0.0%	0	0.0%	1	1.6%	0	0.0%	4	2.2%	5	0.9%
全体(人)																		
男性	7		23		22		37		34		32		33		85		273	
女性	19		17		18		28		46		32		29		97		286	
男女合計	26		40		40		65		80		64		62		182		559	

会 津

	10	割合	20	割合	30	割合	40	割合	50	割合	64	割合	69	割合	70～	割合	全体数	割合
1と回答																		
男性	2	10.0%	1	3.6%	1	3.4%	1	2.9%	2	4.3%	2	4.0%	0	0.0%	1	1.0%	10	2.8%
女性	0	0.0%	2	9.5%	3	9.4%	3	8.8%	6	8.3%	0	0.0%	1	2.1%	3	2.6%	18	4.7%
男女合計	2	5.9%	3	6.1%	4	6.6%	4	5.9%	8	6.7%	2	2.2%	1	1.1%	4	1.9%	28	3.8%
2と回答																		
男性	2	10.0%	1	3.6%	1	3.4%	7	20.6%	2	4.3%	8	16.0%	4	8.9%	16	16.3%	41	11.7%
女性	3	21.4%	2	9.5%	6	18.8%	4	11.8%	14	19.4%	15	34.9%	12	25.0%	29	25.2%	85	22.4%
男女合計	5	14.7%	3	6.1%	7	11.5%	11	16.2%	16	13.4%	23	24.7%	16	17.2%	45	21.1%	126	17.3%
3と回答																		
男性	16	80.0%	26	92.9%	27	93.1%	26	76.5%	43	91.5%	40	80.0%	41	91.1%	80	81.6%	299	85.2%
女性	11	78.6%	16	76.2%	23	71.9%	27	79.4%	52	72.2%	28	65.1%	34	70.8%	81	70.4%	272	71.8%
男女合計	27	79.4%	42	85.7%	50	82.0%	53	77.9%	95	79.8%	68	73.1%	75	80.6%	161	75.6%	571	78.2%
無回答																		
男性	0	0.0%	0	0.0%	0	0.0%	0	0.0%	0	0.0%	0	0.0%	0	0.0%	1	1.0%	1	0.3%
女性	0	0.0%	1	4.8%	0	0.0%	0	0.0%	0	0.0%	0	0.0%	1	2.1%	2	1.7%	4	1.1%
男女合計	0	0.0%	1	2.0%	0	0.0%	0	0.0%	0	0.0%	0	0.0%	1	1.1%	3	1.4%	5	0.7%
全体(人)																		
男性	20		28		29		34		47		50		45		98		351	
女性	14		21		32		34		72		43		48		115		379	
男女合計	34		49		61		68		119		93		93		213		730	

南 会 津

	10	割合	20	割合	30	割合	40	割合	50	割合	64	割合	69	割合	70～	割合	全体数	割合
1と回答																		
男性	0	0.0%	0	0.0%	0	0.0%	0	0.0%	0	0.0%	0	0.0%	0	0.0%	0	0.0%	0	0.0%
女性	1	50.0%	0	0.0%	0	0.0%	0	0.0%	1	25.0%	1	20.0%	0	0.0%	0	0.0%	3	6.4%
男女合計	1	50.0%	0	0.0%	0	0.0%	0	0.0%	1	9.1%	1	14.3%	0	0.0%	0	0.0%	3	3.0%
2と回答																		
男性	0	0.0%	2	66.7%	1	33.3%	1	11.1%	2	28.6%	0	0.0%	0	0.0%	4	18.2%	10	19.2%
女性	0	0.0%	1	50.0%	0	0.0%	2	33.3%	1	25.0%	2	40.0%	3	42.9%	9	45.0%	18	38.3%
男女合計	0	0.0%	3	60.0%	1	25.0%	3	20.0%	3	27.3%	2	28.6%	3	23.1%	13	31.0%	28	28.3%
3と回答																		
男性	0	0.0%	1	33.3%	2	66.7%	7	77.8%	5	71.4%	2	100.0%	6	100.0%	18	81.8%	41	78.8%
女性	1	50.0%	1	50.0%	1	100.0%	4	66.7%	2	50.0%	2	40.0%	4	57.1%	11	55.0%	26	55.3%
男女合計	1	50.0%	2	40.0%	3	75.0%	11	73.3%	7	63.6%	4	57.1%	10	76.9%	29	69.0%	67	67.7%
無回答																		
男性	0	0.0%	0	0.0%	0	0.0%	1	11.1%	0	0.0%	0	0.0%	0	0.0%	0	0.0%	1	1.9%
女性	0	0.0%	0	0.0%	0	0.0%	0	0.0%	0	0.0%	0	0.0%	0	0.0%	0	0.0%	0	0.0%
男女合計	0	0.0%	0	0.0%	0	0.0%	1	6.7%	0	0.0%	0	0.0%	0	0.0%	0	0.0%	1	1.0%
全体(人)																		
男性	0		3		3		9		7		2		6		22		52	
女性	2		2		1		6		4		5		7		20		47	
男女合計	2		5		4		15		11		7		13		42		99	

相 双

	10	割合	20	割合	30	割合	40	割合	50	割合	64	割合	69	割合	70～	割合	全体数	割合
1と回答																		
男性	1	20.0%	0	0.0%	0	0.0%	0	0.0%	2	22.2%	0	0.0%	0	0.0%	0	0.0%	3	1.9%
女性	0	0.0%	0	0.0%	1	16.7%	4	22.2%	4	23.5%	0	0.0%	1	4.3%	2	3.2%	12	7.5%
男女合計	1	7.7%	0	0.0%	1	8.3%	4	12.1%	6	23.1%	0	0.0%	1	2.0%	2	1.4%	15	4.7%
2と回答																		
男性	0	0.0%	0	0.0%	0	0.0%	1	6.7%	0	0.0%	3	15.8%	3	11.1%	12	15.6%	19	11.9%
女性	1	12.5%	0	0.0%	2	33.3%	7	38.9%	3	17.6%	3	16.7%	5	21.7%	14	22.2%	35	22.0%
男女合計	1	7.7%	0	0.0%	2	16.7%	8	24.2%	3	11.5%	6	16.2%	8	16.0%	26	18.6%	54	16.9%
3と回答																		
男性	4	80.0%	2	100.0%	6	100.0%	14	93.3%	7	77.8%	16	84.2%	24	88.9%	65	84.4%	138	86.3%
女性	7	87.5%	6	100.0%	3	50.0%	7	38.9%	10	58.8%	15	83.3%	17	73.9%	47	74.6%	112	70.4%
男女合計	11	84.6%	8	100.0%	9	75.0%	21	63.6%	17	65.4%	31	83.8%	41	82.0%	112	80.0%	250	78.4%
無回答																		
男性	0	0.0%	0	0.0%	0	0.0%	0	0.0%	0	0.0%	0	0.0%	0	0.0%	0	0.0%	0	0.0%
女性	0	0.0%	0	0.0%	0	0.0%	0	0.0%	0	0.0%	0	0.0%	0	0.0%	0	0.0%	0	0.0%
男女合計	0	0.0%	0	0.0%	0	0.0%	0	0.0%	0	0.0%	0	0.0%	0	0.0%	0	0.0%	0	0.0%
全体(人)																		
男性	5		2		6		15		9		19		27		77		160	
女性	8		6		6		18		17		18		23		63		159	
男女合計	13		8		12		33		26		37		50		140		319	

いわき

	10	割合	20	割合	30	割合	40	割合	50	割合	64	割合	69	割合	70～	割合	全体数	割合
1と回答																		
男性	1	5.3%	3	13.0%	3	5.9%	1	1.7%	1	1.5%	0	0.0%	1	2.6%	1	0.7%	11	2.6%
女性	0	0.0%	1	3.2%	6	13.3%	3	4.9%	4	6.3%	1	2.4%	1	2.0%	11	7.0%	27	5.8%
男女合計	1	2.9%	4	7.4%	9	9.4%	4	3.3%	5	3.8%	1	1.3%	2	2.3%	12	4.1%	38	4.3%
2と回答																		
男性	1	5.3%	1	4.3%	3	5.9%	5	8.3%	8	11.8%	6	17.1%	3	7.9%	25	18.2%	52	12.1%
女性	3	20.0%	2	6.5%	7	15.6%	19	31.1%	13	20.6%	13	31.7%	14	28.6%	35	22.3%	106	22.9%
男女合計	4	11.8%	3	5.6%	10	10.4%	24	19.8%	21	16.0%	19	25.0%	17	19.5%	60	20.4%	158	17.7%
3と回答																		
男性	17	89.5%	19	82.6%	45	88.2%	54	90.0%	59	86.8%	29	82.9%	34	89.5%	110	80.3%	367	85.2%
女性	12	80.0%	28	90.3%	32	71.1%	39	63.9%	46	73.0%	27	65.9%	34	69.4%	109	69.4%	327	70.8%
男女合計	29	85.3%	47	87.0%	77	80.2%	93	76.9%	105	80.2%	56	73.7%	68	78.2%	219	74.5%	694	77.7%
無回答																		
男性	0	0.0%	0	0.0%	0	0.0%	0	0.0%	0	0.0%	0	0.0%	0	0.0%	1	0.7%	1	0.2%
女性	0	0.0%	0	0.0%	0	0.0%	0	0.0%	0	0.0%	0	0.0%	0	0.0%	2	1.3%	2	0.4%
男女合計	0	0.0%	0	0.0%	0	0.0%	0	0.0%	0	0.0%	0	0.0%	0	0.0%	3	1.0%	3	0.3%
全体(人)																		
男性	19		23		51		60		68		35		38		137		431	
女性	15		31		45		61		63		41		49		157		462	
男女合計	34		54		96		121		131		76		87		294		893	

全県(60歳以上・再掲)

	64	割合	69	割合	70	割合	80	割合	90	割合	全体数	割合
1と回答												
男性	8	3.0%	6	2.1%	8	1.6%	8	3.0%	0	0.0%	30	2.2%
女性	12	4.6%	8	2.6%	23	4.5%	10	3.1%	2	2.4%	55	3.7%
男女合計	20	3.8%	14	2.4%	31	3.1%	18	3.0%	2	1.7%	85	3.0%
2と回答												
男性	32	12.2%	32	11.2%	84	16.9%	56	20.7%	5	13.2%	209	15.4%
女性	72	27.7%	71	23.2%	128	25.1%	74	22.9%	9	10.8%	354	23.9%
男女合計	104	19.9%	103	17.4%	212	21.1%	130	21.9%	14	11.6%	563	19.9%
3と回答												
男性	223	84.8%	246	86.3%	401	80.7%	204	75.3%	33	86.8%	1107	81.8%
女性	175	67.3%	224	73.2%	355	69.7%	228	70.6%	72	86.7%	1054	71.2%
男女合計	398	76.1%	470	79.5%	756	75.1%	432	72.7%	105	86.8%	2161	76.2%
無回答												
男性	0	0.0%	1	0.4%	4	0.8%	3	1.1%	0	0.0%	8	0.6%
女性	1	0.4%	3	1.0%	3	0.6%	11	3.4%	0	0.0%	18	1.2%
男女合計	1	0.2%	4	0.7%	7	0.7%	14	2.4%	0	0.0%	26	0.9%
全体(人)												
男性	263		285		497		271		38		1354	
女性	260		306		509		323		83		1481	
男女合計	523		591		1006		594		121		2835	

7 食生活（栄養バランス）の状況（調査票 問7）

問7 あなたは、日頃から栄養バランスのとれた食生活を実践していますか。

1 はい 2 いいえ

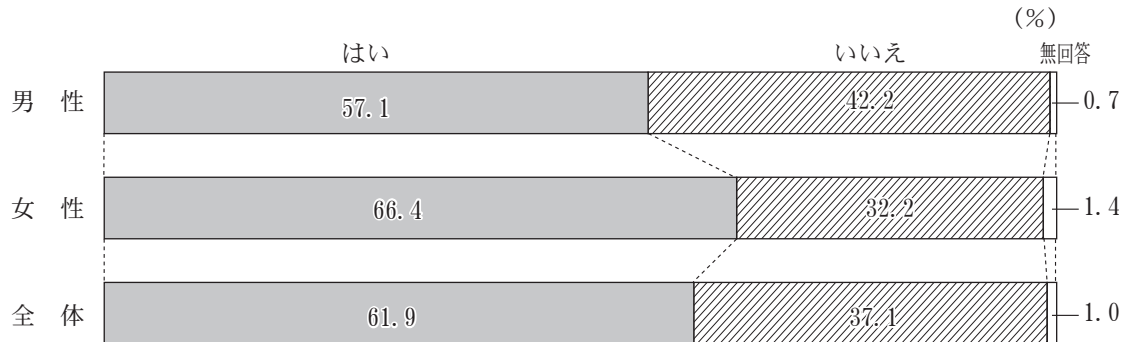

	10	割合	20	割合	30	割合	40	割合	50	割合	64	割合	69	割合	70	割合	80	割合	90	割合	全体数	割合
1と回答																						
男性	72	60.5%	69	41.6%	110	43.8%	192	51.3%	198	50.5%	153	58.2%	192	67.4%	315	63.4%	187	69.0%	28	73.7%	1516	57.1%
女性	76	61.3%	81	45.3%	151	61.4%	229	67.4%	282	63.9%	178	68.5%	219	71.6%	363	71.3%	230	71.2%	58	69.9%	1867	66.4%
男女合計	148	60.9%	150	43.5%	261	52.5%	421	59.0%	480	57.6%	331	63.3%	411	69.5%	678	67.4%	417	70.2%	86	71.1%	3383	61.9%
2と回答																						
男性	47	39.5%	97	58.4%	140	55.8%	179	47.9%	193	49.2%	108	41.1%	92	32.3%	176	35.4%	81	29.9%	9	23.7%	1122	42.2%
女性	47	37.9%	98	54.7%	95	38.6%	110	32.4%	157	35.6%	78	30.0%	84	27.5%	135	26.5%	77	23.8%	24	28.9%	905	32.2%
男女合計	94	38.7%	195	56.5%	235	47.3%	289	40.5%	350	42.0%	186	35.6%	176	29.8%	311	30.9%	158	26.6%	33	27.3%	2027	37.1%
無回答																						
男性	0	0.0%	0	0.0%	1	0.4%	3	0.8%	1	0.3%	2	0.8%	1	0.4%	6	1.2%	3	1.1%	1	2.6%	18	0.7%
女性	1	0.8%	0	0.0%	0	0.0%	1	0.3%	2	0.5%	4	1.5%	3	1.0%	11	2.2%	16	5.0%	1	1.2%	39	1.4%
男女合計	1	0.4%	0	0.0%	1	0.2%	4	0.6%	3	0.4%	6	1.1%	4	0.7%	17	1.7%	19	3.2%	2	1.7%	57	1.0%
全体(人)																						
男性	119		166		251		374		392		263		285		497		271		38		2656	
女性	124		179		246		340		441		260		306		509		323		83		2811	
男女合計	243		345		497		714		833		523		591		1006		594		121		5467	

県 北

	10	割合	20	割合	30	割合	40	割合	50	割合	64	割合	69	割合	70～	割合	全体数	割合
1と回答																		
男性	18	51.4%	20	41.7%	46	50.0%	72	56.3%	65	55.1%	41	66.1%	45	76.3%	119	62.6%	426	58.2%
女性	24	64.9%	24	47.1%	55	62.5%	73	70.9%	89	65.9%	47	74.6%	63	76.8%	167	71.7%	542	68.4%
男女合計	42	58.3%	44	44.4%	101	56.1%	145	62.8%	154	60.9%	88	70.4%	108	76.6%	286	67.6%	968	63.5%
2と回答																		
男性	17	48.6%	28	58.3%	46	50.0%	55	43.0%	53	44.9%	21	33.9%	14	23.7%	69	36.3%	303	41.4%
女性	13	35.1%	27	52.9%	33	37.5%	30	29.1%	46	34.1%	15	23.8%	18	22.0%	56	24.0%	238	30.1%
男女合計	30	41.7%	55	55.6%	79	43.9%	85	36.8%	99	39.1%	36	28.8%	32	22.7%	125	29.6%	541	35.5%
無回答																		
男性	0	0.0%	0	0.0%	0	0.0%	1	0.8%	0	0.0%	0	0.0%	0	0.0%	2	1.1%	3	0.4%
女性	0	0.0%	0	0.0%	0	0.0%	0	0.0%	0	0.0%	1	1.6%	1	1.2%	10	4.3%	12	1.5%
男女合計	0	0.0%	0	0.0%	0	0.0%	1	0.4%	0	0.0%	1	0.8%	1	0.7%	12	2.8%	15	1.0%
全体(人)																		
男性	35		48		92		128		118		62		59		190		732	
女性	37		51		88		103		135		63		82		233		792	
男女合計	72		99		180		231		253		125		141		423		1524	

県 中

	10	割合	20	割合	30	割合	40	割合	50	割合	64	割合	69	割合	70～	割合	全体数	割合
1と回答																		
男性	19	57.6%	14	35.9%	19	39.6%	46	50.5%	48	44.0%	34	54.0%	51	66.2%	133	67.5%	364	55.4%
女性	18	62.1%	25	49.0%	34	60.7%	52	57.8%	66	63.5%	39	67.2%	49	72.1%	161	70.0%	444	64.7%
男女合計	37	59.7%	39	43.3%	53	51.0%	98	54.1%	114	53.5%	73	60.3%	100	69.0%	294	68.9%	808	60.2%
2と回答																		
男性	14	42.4%	25	64.1%	29	60.4%	44	48.4%	60	55.0%	29	46.0%	26	33.8%	62	31.5%	289	44.0%
女性	11	37.9%	26	51.0%	22	39.3%	38	42.2%	36	34.6%	18	31.0%	18	26.5%	65	28.3%	234	34.1%
男女合計	25	40.3%	51	56.7%	51	49.0%	82	45.3%	96	45.1%	47	38.8%	44	30.3%	127	29.7%	523	38.9%
無回答																		
男性	0	0.0%	0	0.0%	0	0.0%	1	1.1%	1	0.9%	0	0.0%	0	0.0%	2	1.0%	4	0.6%
女性	0	0.0%	0	0.0%	0	0.0%	0	0.0%	2	1.9%	1	1.7%	1	1.5%	4	1.7%	8	1.2%
男女合計	0	0.0%	0	0.0%	0	0.0%	1	0.6%	3	1.4%	1	0.8%	1	0.7%	6	1.4%	12	0.9%
全体(人)																		
男性	33		39		48		91		109		63		77		197		657	
女性	29		51		56		90		104		58		68		230		686	
男女合計	62		90		104		181		213		121		145		427		1343	

県 南

	10	割合	20	割合	30	割合	40	割合	50	割合	64	割合	69	割合	70～	割合	全体数	割合
1と回答																		
男性	4	57.1%	11	47.8%	7	31.8%	15	40.5%	13	38.2%	19	59.4%	24	72.7%	54	63.5%	147	53.8%
女性	9	47.4%	7	41.2%	10	55.6%	20	71.4%	23	50.0%	19	59.4%	20	69.0%	70	72.2%	178	62.2%
男女合計	13	50.0%	18	45.0%	17	42.5%	35	53.8%	36	45.0%	38	59.4%	44	71.0%	124	68.1%	325	58.1%
2と回答																		
男性	3	42.9%	12	52.2%	14	63.6%	21	56.8%	21	61.8%	12	37.5%	9	27.3%	29	34.1%	121	44.3%
女性	9	47.4%	10	58.8%	8	44.4%	8	28.6%	23	50.0%	11	34.4%	8	27.6%	24	24.7%	101	35.3%
男女合計	12	46.2%	22	55.0%	22	55.0%	29	44.6%	44	55.0%	23	35.9%	17	27.4%	53	29.1%	222	39.7%
無回答																		
男性	0	0.0%	0	0.0%	1	4.5%	1	2.7%	0	0.0%	1	3.1%	0	0.0%	2	2.4%	5	1.8%
女性	1	5.3%	0	0.0%	0	0.0%	0	0.0%	0	0.0%	2	6.3%	1	3.4%	3	3.1%	7	2.4%
男女合計	1	3.8%	0	0.0%	1	2.5%	1	1.5%	0	0.0%	3	4.7%	1	1.6%	5	2.7%	12	2.1%
全体(人)																		
男性	7		23		22		37		34		32		33		85		273	
女性	19		17		18		28		46		32		29		97		286	
男女合計	26		40		40		65		80		64		62		182		559	

会 津

	10	割合	20	割合	30	割合	40	割合	50	割合	64	割合	69	割合	70～	割合	全体数	割合
1と回答																		
男性	13	65.0%	10	35.7%	12	41.4%	15	44.1%	22	46.8%	29	58.0%	25	55.6%	66	67.3%	192	54.7%
女性	7	50.0%	9	42.9%	19	59.4%	24	70.6%	44	61.1%	28	65.1%	34	70.8%	79	68.7%	244	64.4%
男女合計	20	58.8%	19	38.8%	31	50.8%	39	57.4%	66	55.5%	57	61.3%	59	63.4%	145	68.1%	436	59.7%
2と回答																		
男性	7	35.0%	18	64.3%	17	58.6%	19	55.9%	25	53.2%	21	42.0%	20	44.4%	32	32.7%	159	45.3%
女性	7	50.0%	12	57.1%	13	40.6%	10	29.4%	28	38.9%	15	34.9%	14	29.2%	30	26.1%	129	34.0%
男女合計	14	41.2%	30	61.2%	30	49.2%	29	42.6%	53	44.5%	36	38.7%	34	36.6%	62	29.1%	288	39.5%
無回答																		
男性	0	0.0%	0	0.0%	0	0.0%	0	0.0%	0	0.0%	0	0.0%	0	0.0%	0	0.0%	0	0.0%
女性	0	0.0%	0	0.0%	0	0.0%	0	0.0%	0	0.0%	0	0.0%	0	0.0%	6	5.2%	6	1.6%
男女合計	0	0.0%	0	0.0%	0	0.0%	0	0.0%	0	0.0%	0	0.0%	0	0.0%	6	2.8%	6	0.8%
全体(人)																		
男性	20		28		29		34		47		50		45		98		351	
女性	14		21		32		34		72		43		48		115		379	
男女合計	34		49		61		68		119		93		93		213		730	

南会津

	10	割合	20	割合	30	割合	40	割合	50	割合	64	割合	69	割合	70～	割合	全体数	割合	
1と回答																			
男性	0	0.0%	2	66.7%	1	33.3%	5	55.6%	3	42.9%	2	100.0%	3	50.0%	16	72.7%		32	61.5%
女性	2	100.0%	1	50.0%	0	0.0%	6	100.0%	4	100.0%	4	80.0%	4	57.1%	17	85.0%		38	80.9%
男女合計	2	100.0%	3	60.0%	1	25.0%	11	73.3%	7	63.6%	6	85.7%	7	53.8%	33	78.6%		70	70.7%
2と回答																			
男性	0	0.0%	1	33.3%	2	66.7%	4	44.4%	4	57.1%	0	0.0%	3	50.0%	6	27.3%		20	38.5%
女性	0	0.0%	1	50.0%	1	100.0%	0	0.0%	0	0.0%	1	20.0%	3	42.9%	3	15.0%		9	19.1%
男女合計	0	0.0%	2	40.0%	3	75.0%	4	26.7%	4	36.4%	1	14.3%	6	46.2%	9	21.4%		29	29.3%
無回答																			
男性	0	0.0%	0	0.0%	0	0.0%	0	0.0%	0	0.0%	0	0.0%	0	0.0%	0	0.0%		0	0.0%
女性	0	0.0%	0	0.0%	0	0.0%	0	0.0%	0	0.0%	0	0.0%	0	0.0%	0	0.0%		0	0.0%
男女合計	0	0.0%	0	0.0%	0	0.0%	0	0.0%	0	0.0%	0	0.0%	0	0.0%	0	0.0%		0	0.0%
全体(人)																			
男性	0		3		3		9		7		2		6		22			52	
女性	2		2		1		6		4		5		7		20			47	
男女合計	2		5		4		15		11		7		13		42			99	

相 双

	10	割合	20	割合	30	割合	40	割合	50	割合	64	割合	69	割合	70～	割合	全体数	割合	
1と回答																			
男性	2	40.0%	1	50.0%	3	50.0%	11	73.3%	5	55.6%	7	36.8%	22	81.5%	48	62.3%		99	61.9%
女性	7	87.5%	0	0.0%	3	50.0%	13	72.2%	9	52.9%	12	66.7%	18	78.3%	37	58.7%		99	62.3%
男女合計	9	69.2%	1	12.5%	6	50.0%	24	72.7%	14	53.8%	19	51.4%	40	80.0%	85	60.7%		198	62.1%
2と回答																			
男性	3	60.0%	1	50.0%	3	50.0%	4	26.7%	4	44.4%	12	63.2%	5	18.5%	26	33.8%		58	36.3%
女性	1	12.5%	6	100.0%	3	50.0%	5	27.8%	8	47.1%	6	33.3%	5	21.7%	25	39.7%		59	37.1%
男女合計	4	30.8%	7	87.5%	6	50.0%	9	27.3%	12	46.2%	18	48.6%	10	20.0%	51	36.4%		117	36.7%
無回答																			
男性	0	0.0%	0	0.0%	0	0.0%	0	0.0%	0	0.0%	0	0.0%	0	0.0%	3	3.9%		3	1.9%
女性	0	0.0%	0	0.0%	0	0.0%	0	0.0%	0	0.0%	0	0.0%	0	0.0%	1	1.6%		1	0.6%
男女合計	0	0.0%	0	0.0%	0	0.0%	0	0.0%	0	0.0%	0	0.0%	0	0.0%	4	2.9%		4	1.3%
全体(人)																			
男性	5		2		6		15		9		19		27		77			160	
女性	8		6		6		18		17		18		23		63			159	
男女合計	13		8		12		33		26		37		50		140			319	

いわき

	10	割合	20	割合	30	割合	40	割合	50	割合	64	割合	69	割合	70～	割合	全体数	割合	
1と回答																			
男性	16	84.2%	11	47.8%	22	43.1%	28	46.7%	42	61.8%	21	60.0%	22	57.9%	94	68.6%		256	59.4%
女性	9	60.0%	15	48.4%	30	66.7%	41	67.2%	47	74.6%	29	70.7%	31	63.3%	120	76.4%		322	69.7%
男女合計	25	73.5%	26	48.1%	52	54.2%	69	57.0%	89	67.9%	50	65.8%	53	60.9%	214	72.8%		578	64.7%
2と回答																			
男性	3	15.8%	12	52.2%	29	56.9%	32	53.3%	26	38.2%	13	37.1%	15	39.5%	42	30.7%		172	39.9%
女性	6	40.0%	16	51.6%	15	33.3%	19	31.1%	16	25.4%	12	29.3%	18	36.7%	33	21.0%		135	29.2%
男女合計	9	26.5%	28	51.9%	44	45.8%	51	42.1%	42	32.1%	25	32.9%	33	37.9%	75	25.5%		307	34.4%
無回答																			
男性	0	0.0%	0	0.0%	0	0.0%	0	0.0%	0	0.0%	1	2.9%	1	2.6%	1	0.7%		3	0.7%
女性	0	0.0%	0	0.0%	0	0.0%	1	1.6%	0	0.0%	0	0.0%	0	0.0%	4	2.5%		5	1.1%
男女合計	0	0.0%	0	0.0%	0	0.0%	1	0.8%	0	0.0%	1	1.3%	1	1.1%	5	1.7%		8	0.9%
全体(人)																			
男性	19		23		51		60		68		35		38		137			431	
女性	15		31		45		61		63		41		49		157			462	
男女合計	34		54		96		121		131		76		87		294			893	

全県 (60歳以上・再掲)

	64	割合	69	割合	70	割合	80	割合	90	割合	全体数	割合	
1と回答													
男性	153	58.2%	192	67.4%	315	63.4%	187	69.0%	28	73.7%		875	64.6%
女性	178	68.5%	219	71.6%	363	71.3%	230	71.2%	58	69.9%		1048	70.8%
男女合計	331	63.3%	411	69.5%	678	67.4%	417	70.2%	86	71.1%		1923	67.8%
2と回答													
男性	108	41.1%	92	32.3%	176	35.4%	81	29.9%	9	23.7%		466	34.4%
女性	78	30.0%	84	27.5%	135	26.5%	77	23.8%	24	28.9%		398	26.9%
男女合計	186	35.6%	176	29.8%	311	30.9%	158	26.6%	33	27.3%		864	30.5%
無回答													
男性	2	0.8%	1	0.4%	6	1.2%	3	1.1%	1	2.6%		13	1.0%
女性	4	1.5%	3	1.0%	11	2.2%	16	5.0%	1	1.2%		35	2.4%
男女合計	6	1.1%	4	0.7%	17	1.7%	19	3.2%	2	1.7%		48	1.7%
全体(人)													
男性	263		285		497		271		38			1354	
女性	260		306		509		323		83			1481	
男女合計	523		591		1006		594		121			2835	

8 「フレイル」の認知度（調査票 問8）

問8 あなたは、フレイルを知っていますか。

1 知っている 2 知らない

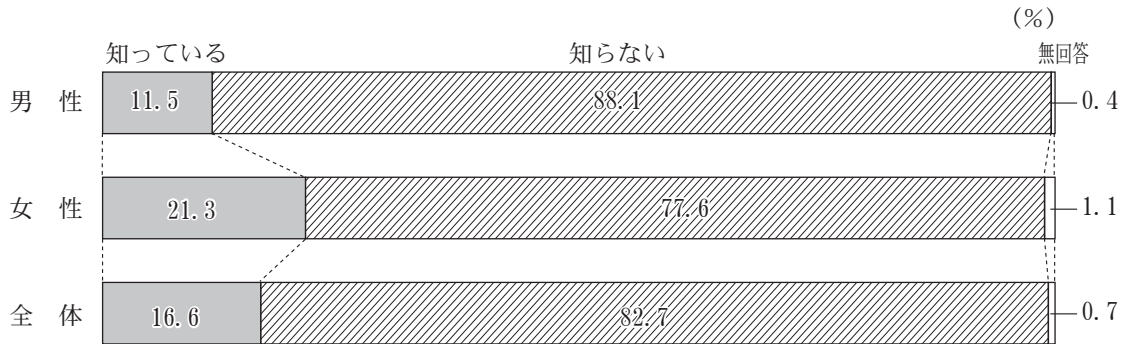

	10	割合	20	割合	30	割合	40	割合	50	割合	64	割合	69	割合	70	割合	80	割合	90	割合	全体数	割合
1と回答																						
男性	4	3.4%	15	9.0%	23	9.2%	32	8.6%	37	9.4%	31	11.8%	46	16.1%	71	14.3%	43	15.9%	4	10.5%	306	11.5%
女性	6	4.8%	31	17.3%	32	13.0%	52	15.3%	92	20.9%	67	25.8%	81	26.5%	147	28.9%	82	25.4%	9	10.8%	599	21.3%
男女合計	10	4.1%	46	13.3%	55	11.1%	84	11.8%	129	15.5%	98	18.7%	127	21.5%	218	21.7%	125	21.0%	13	10.7%	905	16.6%
2と回答																						
男性	115	96.6%	151	91.0%	228	90.8%	341	91.2%	355	90.6%	232	88.2%	239	83.9%	423	85.1%	223	82.3%	33	86.8%	2340	88.1%
女性	118	95.2%	148	82.7%	214	87.0%	288	84.7%	349	79.1%	190	73.1%	219	71.6%	353	69.4%	230	71.2%	72	86.7%	2181	77.6%
男女合計	233	95.9%	299	86.7%	442	88.9%	629	88.1%	704	84.5%	422	80.7%	458	77.5%	776	77.1%	453	76.3%	105	86.8%	4521	82.7%
無回答																						
男性	0	0.0%	0	0.0%	0	0.0%	1	0.3%	0	0.0%	0	0.0%	0	0.0%	3	0.6%	5	1.8%	1	2.6%	10	0.4%
女性	0	0.0%	0	0.0%	0	0.0%	0	0.0%	0	0.0%	3	1.2%	6	2.0%	9	1.8%	11	3.4%	2	2.4%	31	1.1%
男女合計	0	0.0%	0	0.0%	0	0.0%	1	0.1%	0	0.0%	3	0.6%	6	1.0%	12	1.2%	16	2.7%	3	2.5%	41	0.7%
全体(人)																						
男性	119		166		251		374		392		263		285		497		271		38		2656	
女性	124		179		246		340		441		260		306		509		323		83		2811	
男女合計	243		345		497		714		833		523		591		1006		594		121		5467	

県 北

	10	割合	20	割合	30	割合	40	割合	50	割合	64	割合	69	割合	70～	割合	全体数	割合
1と回答																		
男性	2	5.7%	4	8.3%	11	12.0%	10	7.8%	13	11.0%	9	14.5%	13	22.0%	27	14.2%	89	12.2%
女性	1	2.7%	9	17.6%	11	12.5%	18	17.5%	35	25.9%	17	27.0%	21	25.6%	67	28.8%	179	22.6%
男女合計	3	4.2%	13	13.1%	22	12.2%	28	12.1%	48	19.0%	26	20.8%	34	24.1%	94	22.2%	268	17.6%
2と回答																		
男性	33	94.3%	44	91.7%	81	88.0%	117	91.4%	105	89.0%	53	85.5%	46	78.0%	162	85.3%	641	87.6%
女性	36	97.3%	42	82.4%	77	87.5%	85	82.5%	100	74.1%	45	71.4%	58	70.7%	162	69.5%	605	76.4%
男女合計	69	95.8%	86	86.9%	158	87.8%	202	87.4%	205	81.0%	98	78.4%	104	73.8%	324	76.6%	1246	81.8%
無回答																		
男性	0	0.0%	0	0.0%	0	0.0%	1	0.8%	0	0.0%	0	0.0%	0	0.0%	1	0.5%	2	0.3%
女性	0	0.0%	0	0.0%	0	0.0%	0	0.0%	0	0.0%	1	1.6%	3	3.7%	4	1.7%	8	1.0%
男女合計	0	0.0%	0	0.0%	0	0.0%	1	0.4%	0	0.0%	1	0.8%	3	2.1%	5	1.2%	10	0.7%
全体(人)																		
男性	35		48		92		128		118		62		59		190		732	
女性	37		51		88		103		135		63		82		233		792	
男女合計	72		99		180		231		253		125		141		423		1524	

県 中

	10	割合	20	割合	30	割合	40	割合	50	割合	64	割合	69	割合	70～	割合	全体数	割合
1と回答																		
男性	2	6.1%	3	7.7%	5	10.4%	12	13.2%	12	11.0%	5	7.9%	15	19.5%	21	10.7%	75	11.4%
女性	1	3.4%	9	17.6%	7	12.5%	15	16.7%	18	17.3%	15	25.9%	18	26.5%	61	26.5%	144	21.0%
男女合計	3	4.8%	12	13.3%	12	11.5%	27	14.9%	30	14.1%	20	16.5%	33	22.8%	82	19.2%	219	16.3%
2と回答																		
男性	31	93.9%	36	92.3%	43	89.6%	79	86.8%	97	89.0%	58	92.1%	62	80.5%	176	89.3%	582	88.6%
女性	28	96.6%	42	82.4%	49	87.5%	75	83.3%	86	82.7%	43	74.1%	49	72.1%	162	70.4%	534	77.8%
男女合計	59	95.2%	78	86.7%	92	88.5%	154	85.1%	183	85.9%	101	83.5%	111	76.6%	338	79.2%	1116	83.1%
無回答																		
男性	0	0.0%	0	0.0%	0	0.0%	0	0.0%	0	0.0%	0	0.0%	0	0.0%	0	0.0%	0	0.0%
女性	0	0.0%	0	0.0%	0	0.0%	0	0.0%	0	0.0%	0	0.0%	1	1.5%	7	3.0%	8	1.2%
男女合計	0	0.0%	0	0.0%	0	0.0%	0	0.0%	0	0.0%	0	0.0%	1	0.7%	7	1.6%	8	0.6%
全体(人)																		
男性	33		39		48		91		109		63		77		197		657	
女性	29		51		56		90		104		58		68		230		686	
男女合計	62		90		104		181		213		121		145		427		1343	

県 南

	10	割合	20	割合	30	割合	40	割合	50	割合	64	割合	69	割合	70～	割合	全体数	割合
1と回答																		
男性	0	0.0%	0	0.0%	2	9.1%	2	5.4%	0	0.0%	5	15.6%	4	12.1%	12	14.1%	25	9.2%
女性	0	0.0%	3	17.6%	4	22.2%	3	10.7%	10	21.7%	10	31.3%	11	37.9%	18	18.6%	59	20.6%
男女合計	0	0.0%	3	7.5%	6	15.0%	5	7.7%	10	12.5%	15	23.4%	15	24.2%	30	16.5%	84	15.0%
2と回答																		
男性	7	100.0%	23	100.0%	20	90.9%	35	94.6%	34	100.0%	27	84.4%	29	87.9%	73	85.9%	248	90.8%
女性	19	100.0%	14	82.4%	14	77.8%	25	89.3%	36	78.3%	21	65.6%	18	62.1%	74	76.3%	221	77.3%
男女合計	26	100.0%	37	92.5%	34	85.0%	60	92.3%	70	87.5%	48	75.0%	47	75.8%	147	80.8%	469	83.9%
無回答																		
男性	0	0.0%	0	0.0%	0	0.0%	0	0.0%	0	0.0%	0	0.0%	0	0.0%	0	0.0%	0	0.0%
女性	0	0.0%	0	0.0%	0	0.0%	0	0.0%	0	0.0%	1	3.1%	0	0.0%	5	5.2%	6	2.1%
男女合計	0	0.0%	0	0.0%	0	0.0%	0	0.0%	0	0.0%	1	1.6%	0	0.0%	5	2.7%	6	1.1%
全体(人)																		
男性	7		23		22		37		34		32		33		85		273	
女性	19		17		18		28		46		32		29		97		286	
男女合計	26		40		40		65		80		64		62		182		559	

会 津

	10	割合	20	割合	30	割合	40	割合	50	割合	64	割合	69	割合	70～	割合	全体数	割合
1と回答																		
男性	0	0.0%	4	14.3%	3	10.3%	2	5.9%	6	12.8%	8	16.0%	7	15.6%	16	16.3%	46	13.1%
女性	2	14.3%	5	23.8%	5	15.6%	3	8.8%	14	19.4%	10	23.3%	16	33.3%	24	20.9%	79	20.8%
男女合計	2	5.9%	9	18.4%	8	13.1%	5	7.4%	20	16.8%	18	19.4%	23	24.7%	40	18.8%	125	17.1%
2と回答																		
男性	20	100.0%	24	85.7%	26	89.7%	32	94.1%	41	87.2%	42	84.0%	38	84.4%	80	81.6%	303	86.3%
女性	12	85.7%	16	76.2%	27	84.4%	31	91.2%	58	80.6%	33	76.7%	31	64.6%	88	76.5%	296	78.1%
男女合計	32	94.1%	40	81.6%	53	86.9%	63	92.6%	99	83.2%	75	80.6%	69	74.2%	168	78.9%	599	82.1%
無回答																		
男性	0	0.0%	0	0.0%	0	0.0%	0	0.0%	0	0.0%	0	0.0%	0	0.0%	2	2.0%	2	0.6%
女性	0	0.0%	0	0.0%	0	0.0%	0	0.0%	0	0.0%	0	0.0%	1	2.1%	3	2.6%	4	1.1%
男女合計	0	0.0%	0	0.0%	0	0.0%	0	0.0%	0	0.0%	0	0.0%	1	1.1%	5	2.3%	6	0.8%
全体(人)																		
男性	20		28		29		34		47		50		45		98		351	
女性	14		21		32		34		72		43		48		115		379	
男女合計	34		49		61		68		119		93		93		213		730	

南会津

	10	割合	20	割合	30	割合	40	割合	50	割合	64	割合	69	割合	70～	割合	全体数	割合
1と回答																		
男性	0	0.0%	2	66.7%	0	0.0%	2	22.2%	0	0.0%	1	50.0%	0	0.0%	3	13.6%	8	15.4%
女性	0	0.0%	1	50.0%	0	0.0%	2	33.3%	1	25.0%	0	0.0%	3	42.9%	5	25.0%	12	25.5%
男女合計	0	0.0%	3	60.0%	0	0.0%	4	26.7%	1	9.1%	1	14.3%	3	23.1%	8	19.0%	20	20.2%
2と回答																		
男性	0	0.0%	1	33.3%	3	100.0%	7	77.8%	7	100.0%	1	50.0%	6	100.0%	19	86.4%	44	84.6%
女性	2	100.0%	1	50.0%	1	100.0%	4	66.7%	3	75.0%	5	100.0%	4	57.1%	15	75.0%	35	74.5%
男女合計	2	100.0%	2	40.0%	4	100.0%	11	73.3%	10	90.9%	6	85.7%	10	76.9%	34	81.0%	79	79.8%
無回答																		
男性	0	0.0%	0	0.0%	0	0.0%	0	0.0%	0	0.0%	0	0.0%	0	0.0%	0	0.0%	0	0.0%
女性	0	0.0%	0	0.0%	0	0.0%	0	0.0%	0	0.0%	0	0.0%	0	0.0%	0	0.0%	0	0.0%
男女合計	0	0.0%	0	0.0%	0	0.0%	0	0.0%	0	0.0%	0	0.0%	0	0.0%	0	0.0%	0	0.0%
全体(人)																		
男性	0		3		3		9		7		2		6		22		52	
女性	2		2		1		6		4		5		7		20		47	
男女合計	2		5		4		15		11		7		13		42		99	

相 双

	10	割合	20	割合	30	割合	40	割合	50	割合	64	割合	69	割合	70～	割合	全体数	割合
1と回答																		
男性	0	0.0%	0	0.0%	1	16.7%	1	6.7%	0	0.0%	2	10.5%	3	11.1%	12	15.6%	19	11.9%
女性	0	0.0%	1	16.7%	1	16.7%	2	11.1%	2	11.8%	7	38.9%	5	21.7%	17	27.0%	35	22.0%
男女合計	0	0.0%	1	12.5%	2	16.7%	3	9.1%	2	7.7%	9	24.3%	8	16.0%	29	20.7%	54	16.9%
2と回答																		
男性	5	100.0%	2	100.0%	5	83.3%	14	93.3%	9	100.0%	17	89.5%	24	88.9%	63	81.8%	139	86.9%
女性	8	100.0%	5	83.3%	5	83.3%	16	88.9%	15	88.2%	10	55.6%	18	78.3%	45	71.4%	122	76.7%
男女合計	13	100.0%	7	87.5%	10	83.3%	30	90.9%	24	92.3%	27	73.0%	42	84.0%	108	77.1%	261	81.8%
無回答																		
男性	0	0.0%	0	0.0%	0	0.0%	0	0.0%	0	0.0%	0	0.0%	0	0.0%	2	2.6%	2	1.3%
女性	0	0.0%	0	0.0%	0	0.0%	0	0.0%	0	0.0%	1	5.6%	0	0.0%	1	1.6%	2	1.3%
男女合計	0	0.0%	0	0.0%	0	0.0%	0	0.0%	0	0.0%	1	2.7%	0	0.0%	3	2.1%	4	1.3%
全体(人)																		
男性	5		2		6		15		9		19		27		77		160	
女性	8		6		6		18		17		18		23		63		159	
男女合計	13		8		12		33		26		37		50		140		319	

いわき

	10	割合	20	割合	30	割合	40	割合	50	割合	64	割合	69	割合	70～	割合	全体数	割合
1と回答																		
男性	0	0.0%	2	8.7%	1	2.0%	3	5.0%	6	8.8%	1	2.9%	4	10.5%	27	19.7%	44	10.2%
女性	2	13.3%	3	9.7%	4	8.9%	9	14.8%	12	19.0%	8	19.5%	7	14.3%	46	29.3%	91	19.7%
男女合計	2	5.9%	5	9.3%	5	5.2%	12	9.9%	18	13.7%	9	11.8%	11	12.6%	73	24.8%	135	15.1%
2と回答																		
男性	19	100.0%	21	91.3%	50	98.0%	57	95.0%	62	91.2%	34	97.1%	34	89.5%	106	77.4%	383	88.9%
女性	13	86.7%	28	90.3%	41	91.1%	52	85.2%	51	81.0%	33	80.5%	41	83.7%	109	69.4%	368	79.7%
男女合計	32	94.1%	49	90.7%	91	94.8%	109	90.1%	113	86.3%	67	88.2%	75	86.2%	215	73.1%	751	84.1%
無回答																		
男性	0	0.0%	0	0.0%	0	0.0%	0	0.0%	0	0.0%	0	0.0%	0	0.0%	4	2.9%	4	0.9%
女性	0	0.0%	0	0.0%	0	0.0%	0	0.0%	0	0.0%	0	0.0%	1	2.0%	2	1.3%	3	0.6%
男女合計	0	0.0%	0	0.0%	0	0.0%	0	0.0%	0	0.0%	0	0.0%	1	1.1%	6	2.0%	7	0.8%
全体(人)																		
男性	19		23		51		60		68		35		38		137		431	
女性	15		31		45		61		63		41		49		157		462	
男女合計	34		54		96		121		131		76		87		294		893	

全県(60歳以上・再掲)

	64	割合	69	割合	70	割合	80	割合	90	割合	全体数	割合
1と回答												
男性	31	11.8%	46	16.1%	71	14.3%	43	15.9%	4	10.5%	195	14.4%
女性	67	25.8%	81	26.5%	147	28.9%	82	25.4%	9	10.8%	386	26.1%
男女合計	98	18.7%	127	21.5%	218	21.7%	125	21.0%	13	10.7%	581	20.5%
2と回答												
男性	232	88.2%	239	83.9%	423	85.1%	223	82.3%	33	86.8%	1150	84.9%
女性	190	73.1%	219	71.6%	353	69.4%	230	71.2%	72	86.7%	1064	71.8%
男女合計	422	80.7%	458	77.5%	776	77.1%	453	76.3%	105	86.8%	2214	78.1%
無回答												
男性	0	0.0%	0	0.0%	3	0.6%	5	1.8%	1	2.6%	9	0.7%
女性	3	1.2%	6	2.0%	9	1.8%	11	3.4%	2	2.4%	31	2.1%
男女合計	3	0.6%	6	1.0%	12	1.2%	16	2.7%	3	2.5%	40	1.4%
全体(人)												
男性	263		285		497		271		38		1354	
女性	260		306		509		323		83		1481	
男女合計	523		591		1006		594		121		2835	

9 「ロコモティブシンドローム」の認知度（調査票 問9）

問9 あなたは、ロコモティブシンドローム（運動器症候群）を知っていますか。

1 知っている 2 知らない

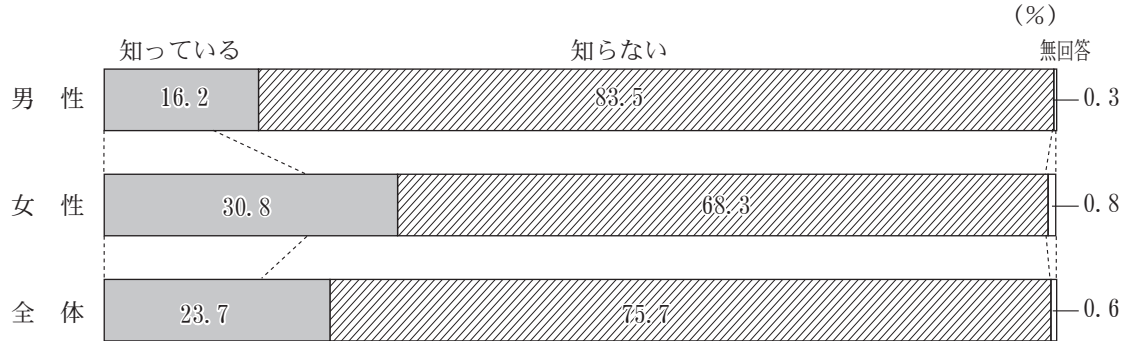

	10	割合	20	割合	30	割合	40	割合	50	割合	64	割合	69	割合	70	割合	80	割合	90	割合	全体数	割合
1と回答																						
男性	8	6.7%	26	15.7%	34	13.5%	51	13.6%	54	13.8%	44	16.7%	60	21.1%	93	18.7%	57	21.0%	3	7.9%	430	16.2%
女性	18	14.5%	41	22.9%	53	21.5%	103	30.3%	155	35.1%	93	35.8%	112	36.6%	200	39.3%	80	24.8%	12	14.5%	867	30.8%
男女合計	26	10.7%	67	19.4%	87	17.5%	154	21.6%	209	25.1%	137	26.2%	172	29.1%	293	29.1%	137	23.1%	15	12.4%	1297	23.7%
2と回答																						
男性	111	93.3%	140	84.3%	217	86.5%	322	86.1%	338	86.2%	218	82.9%	225	78.9%	400	80.5%	212	78.2%	35	92.1%	2218	83.5%
女性	106	85.5%	138	77.1%	193	78.5%	237	69.7%	285	64.6%	164	63.1%	191	62.4%	299	58.7%	238	73.7%	70	84.3%	1921	68.3%
男女合計	217	89.3%	278	80.6%	410	82.5%	559	78.3%	623	74.8%	382	73.0%	416	70.4%	699	69.5%	450	75.8%	105	86.8%	4139	75.7%
無回答																						
男性	0	0.0%	0	0.0%	0	0.0%	1	0.3%	0	0.0%	1	0.4%	0	0.0%	4	0.8%	2	0.7%	0	0.0%	8	0.3%
女性	0	0.0%	0	0.0%	0	0.0%	0	0.0%	1	0.2%	3	1.2%	3	1.0%	10	2.0%	5	1.5%	1	1.2%	23	0.8%
男女合計	0	0.0%	0	0.0%	0	0.0%	1	0.1%	1	0.1%	4	0.8%	3	0.5%	14	1.4%	7	1.2%	1	0.8%	31	0.6%
全体(人)																						
男性	119	166	251	374	392	263	285	497	271	38	2656											
女性	124	179	246	340	441	260	306	509	323	83	2811											
男女合計	243	345	497	714	833	523	591	1006	594	121	5467											

県 北

	10	割合	20	割合	30	割合	40	割合	50	割合	64	割合	69	割合	70～	割合	全体数	割合
1と回答																		
男性	1	2.9%	7	14.6%	14	15.2%	18	14.1%	20	16.9%	9	14.5%	13	22.0%	33	17.4%	115	15.7%
女性	4	10.8%	11	21.6%	16	18.2%	28	27.2%	52	38.5%	25	39.7%	31	37.8%	75	32.2%	242	30.6%
男女合計	5	6.9%	18	18.2%	30	16.7%	46	19.9%	72	28.5%	34	27.2%	44	31.2%	108	25.5%	357	23.4%
2と回答																		
男性	34	97.1%	41	85.4%	78	84.8%	109	85.2%	98	83.1%	53	85.5%	46	78.0%	156	82.1%	615	84.0%
女性	33	89.2%	40	78.4%	72	81.8%	75	72.8%	82	60.7%	37	58.7%	49	59.8%	152	65.2%	540	68.2%
男女合計	67	93.1%	81	81.8%	150	83.3%	184	79.7%	180	71.1%	90	72.0%	95	67.4%	308	72.8%	1155	75.8%
無回答																		
男性	0	0.0%	0	0.0%	0	0.0%	1	0.8%	0	0.0%	0	0.0%	0	0.0%	1	0.5%	2	0.3%
女性	0	0.0%	0	0.0%	0	0.0%	0	0.0%	1	0.7%	1	1.6%	2	2.4%	6	2.6%	10	1.3%
男女合計	0	0.0%	0	0.0%	0	0.0%	1	0.4%	1	0.4%	1	0.8%	2	1.4%	7	1.7%	12	0.8%
全体(人)																		
男性	35		48		92		128		118		62		59		190		732	
女性	37		51		88		103		135		63		82		233		792	
男女合計	72		99		180		231		253		125		141		423		1524	

県 中

	10	割合	20	割合	30	割合	40	割合	50	割合	64	割合	69	割合	70～	割合	全体数	割合
1と回答																		
男性	4	12.1%	6	15.4%	7	14.6%	14	15.4%	21	19.3%	9	14.3%	20	26.0%	31	15.7%	112	17.0%
女性	4	13.8%	14	27.5%	14	25.0%	33	36.7%	43	41.3%	22	37.9%	29	42.6%	80	34.8%	239	34.8%
男女合計	8	12.9%	20	22.2%	21	20.2%	47	26.0%	64	30.0%	31	25.6%	49	33.8%	111	26.0%	351	26.1%
2と回答																		
男性	29	87.9%	33	84.6%	41	85.4%	77	84.6%	88	80.7%	54	85.7%	57	74.0%	164	83.2%	543	82.6%
女性	25	86.2%	37	72.5%	42	75.0%	57	63.3%	61	58.7%	36	62.1%	39	57.4%	147	63.9%	444	64.7%
男女合計	54	87.1%	70	77.8%	83	79.8%	134	74.0%	149	70.0%	90	74.4%	96	66.2%	311	72.8%	987	73.5%
無回答																		
男性	0	0.0%	0	0.0%	0	0.0%	0	0.0%	0	0.0%	0	0.0%	0	0.0%	2	1.0%	2	0.3%
女性	0	0.0%	0	0.0%	0	0.0%	0	0.0%	0	0.0%	0	0.0%	0	0.0%	3	1.3%	3	0.4%
男女合計	0	0.0%	0	0.0%	0	0.0%	0	0.0%	0	0.0%	0	0.0%	0	0.0%	5	1.2%	5	0.4%
全体(人)																		
男性	33		39		48		91		109		63		77		197		657	
女性	29		51		56		90		104		58		68		230		686	
男女合計	62		90		104		181		213		121		145		427		1343	

県 南

	10	割合	20	割合	30	割合	40	割合	50	割合	64	割合	69	割合	70～	割合	全体数	割合
1と回答																		
男性	0	0.0%	0	0.0%	0	0.0%	8	21.6%	2	5.9%	8	25.0%	5	15.2%	12	14.1%	35	12.8%
女性	2	10.5%	4	23.5%	4	22.2%	4	14.3%	13	28.3%	13	40.6%	11	37.9%	23	23.7%	74	25.9%
男女合計	2	7.7%	4	10.0%	4	10.0%	12	18.5%	15	18.8%	21	32.8%	16	25.8%	35	19.2%	109	19.5%
2と回答																		
男性	7	100.0%	23	100.0%	22	100.0%	29	78.4%	32	94.1%	24	75.0%	28	84.8%	72	84.7%	237	86.8%
女性	17	89.5%	13	76.5%	14	77.8%	24	85.7%	33	71.7%	17	53.1%	18	62.1%	70	72.2%	206	72.0%
男女合計	24	92.3%	36	90.0%	36	90.0%	53	81.5%	65	81.3%	41	64.1%	46	74.2%	142	78.0%	443	79.2%
無回答																		
男性	0	0.0%	0	0.0%	0	0.0%	0	0.0%	0	0.0%	0	0.0%	0	0.0%	1	1.2%	1	0.4%
女性	0	0.0%	0	0.0%	0	0.0%	0	0.0%	0	0.0%	2	6.3%	0	0.0%	4	4.1%	6	2.1%
男女合計	0	0.0%	0	0.0%	0	0.0%	0	0.0%	0	0.0%	2	3.1%	0	0.0%	5	2.7%	7	1.3%
全体(人)																		
男性	7		23		22		37		34		32		33		85		273	
女性	19		17		18		28		46		32		29		97		286	
男女合計	26		40		40		65		80		64		62		182		559	

会 津

	10	割合	20	割合	30	割合	40	割合	50	割合	64	割合	69	割合	70～	割合	全体数	割合
1と回答																		
男性	1	5.0%	7	25.0%	5	17.2%	2	5.9%	7	14.9%	7	14.0%	10	22.2%	19	19.4%	58	16.5%
女性	3	21.4%	6	28.6%	9	28.1%	14	41.2%	24	33.3%	14	32.6%	19	39.6%	30	26.1%	119	31.4%
男女合計	4	11.8%	13	26.5%	14	23.0%	16	23.5%	31	26.1%	21	22.6%	29	31.2%	49	23.0%	177	24.2%
2と回答																		
男性	19	95.0%	21	75.0%	24	82.8%	32	94.1%	40	85.1%	42	84.0%	35	77.8%	78	79.6%	291	82.9%
女性	11	78.6%	15	71.4%	23	71.9%	20	58.8%	48	66.7%	29	67.4%	29	60.4%	84	73.0%	259	68.3%
男女合計	30	88.2%	36	73.5%	47	77.0%	52	76.5%	88	73.9%	71	76.3%	64	68.8%	162	76.1%	550	75.3%
無回答																		
男性	0	0.0%	0	0.0%	0	0.0%	0	0.0%	0	0.0%	1	2.0%	0	0.0%	1	1.0%	2	0.6%
女性	0	0.0%	0	0.0%	0	0.0%	0	0.0%	0	0.0%	0	0.0%	0	0.0%	1	0.9%	1	0.3%
男女合計	0	0.0%	0	0.0%	0	0.0%	0	0.0%	0	0.0%	1	1.1%	0	0.0%	2	0.9%	3	0.4%
全体(人)																		
男性	20		28		29		34		47		50		45		98		351	
女性	14		21		32		34		72		43		48		115		379	
男女合計	34		49		61		68		119		93		93		213		730	

南会津

	10	割合	20	割合	30	割合	40	割合	50	割合	64	割合	69	割合	70～	割合	全体数	割合
1と回答																		
男性	0	0.0%	1	33.3%	0	0.0%	2	22.2%	0	0.0%	0	0.0%	1	16.7%	6	27.3%	10	19.2%
女性	2	100.0%	1	50.0%	0	0.0%	4	66.7%	2	50.0%	0	0.0%	3	42.9%	5	25.0%	17	36.2%
男女合計	2	100.0%	2	40.0%	0	0.0%	6	40.0%	2	18.2%	0	0.0%	4	30.8%	11	26.2%	27	27.3%
2と回答																		
男性	0	0.0%	2	66.7%	3	100.0%	7	77.8%	7	100.0%	2	100.0%	5	83.3%	16	72.7%	42	80.8%
女性	0	0.0%	1	50.0%	1	100.0%	2	33.3%	2	50.0%	5	100.0%	4	57.1%	15	75.0%	30	63.8%
男女合計	0	0.0%	3	60.0%	4	100.0%	9	60.0%	9	81.8%	7	100.0%	9	69.2%	31	73.8%	72	72.7%
無回答																		
男性	0	0.0%	0	0.0%	0	0.0%	0	0.0%	0	0.0%	0	0.0%	0	0.0%	0	0.0%	0	0.0%
女性	0	0.0%	0	0.0%	0	0.0%	0	0.0%	0	0.0%	0	0.0%	0	0.0%	0	0.0%	0	0.0%
男女合計	0	0.0%	0	0.0%	0	0.0%	0	0.0%	0	0.0%	0	0.0%	0	0.0%	0	0.0%	0	0.0%
全体(人)																		
男性	0		3		3		9		7		2		6		22		52	
女性	2		2		1		6		4		5		7		20		47	
男女合計	2		5		4		15		11		7		13		42		99	

相 双

	10	割合	20	割合	30	割合	40	割合	50	割合	64	割合	69	割合	70～	割合	全体数	割合
1と回答																		
男性	1	20.0%	0	0.0%	2	33.3%	1	6.7%	1	11.1%	2	10.5%	6	22.2%	20	26.0%	33	20.6%
女性	0	0.0%	1	16.7%	2	33.3%	4	22.2%	5	29.4%	6	33.3%	7	30.4%	20	31.7%	45	28.3%
男女合計	1	7.7%	1	12.5%	4	33.3%	5	15.2%	6	23.1%	8	21.6%	13	26.0%	40	28.6%	78	24.5%
2と回答																		
男性	4	80.0%	2	100.0%	4	66.7%	14	93.3%	8	88.9%	17	89.5%	21	77.8%	57	74.0%	127	79.4%
女性	8	100.0%	5	83.3%	4	66.7%	14	77.8%	12	70.6%	12	66.7%	16	69.6%	43	68.3%	114	71.7%
男女合計	12	92.3%	7	87.5%	8	66.7%	28	84.8%	20	76.9%	29	78.4%	37	74.0%	100	71.4%	241	75.5%
無回答																		
男性	0	0.0%	0	0.0%	0	0.0%	0	0.0%	0	0.0%	0	0.0%	0	0.0%	0	0.0%	0	0.0%
女性	0	0.0%	0	0.0%	0	0.0%	0	0.0%	0	0.0%	0	0.0%	0	0.0%	0	0.0%	0	0.0%
男女合計	0	0.0%	0	0.0%	0	0.0%	0	0.0%	0	0.0%	0	0.0%	0	0.0%	0	0.0%	0	0.0%
全体(人)																		
男性	5		2		6		15		9		19		27		77		160	
女性	8		6		6		18		17		18		23		63		159	
男女合計	13		8		12		33		26		37		50		140		319	

いわき

	10	割合	20	割合	30	割合	40	割合	50	割合	64	割合	69	割合	70～	割合	全体数	割合
1と回答																		
男性	1	5.3%	5	21.7%	6	11.8%	6	10.0%	3	4.4%	9	25.7%	5	13.2%	32	23.4%	67	15.5%
女性	3	20.0%	4	12.9%	8	17.8%	16	26.2%	16	25.4%	13	31.7%	12	24.5%	59	37.6%	131	28.4%
男女合計	4	11.8%	9	16.7%	14	14.6%	22	18.2%	19	14.5%	22	28.9%	17	19.5%	91	31.0%	198	22.2%
2と回答																		
男性	18	94.7%	18	78.3%	45	88.2%	54	90.0%	65	95.6%	26	74.3%	33	86.8%	104	75.9%	363	84.2%
女性	12	80.0%	27	87.1%	37	82.2%	45	73.8%	47	74.6%	28	68.3%	36	73.5%	96	61.1%	328	71.0%
男女合計	30	88.2%	45	83.3%	82	85.4%	99	81.8%	112	85.5%	54	71.1%	69	79.3%	200	68.0%	691	77.4%
無回答																		
男性	0	0.0%	0	0.0%	0	0.0%	0	0.0%	0	0.0%	0	0.0%	0	0.0%	1	0.7%	1	0.2%
女性	0	0.0%	0	0.0%	0	0.0%	0	0.0%	0	0.0%	0	0.0%	1	2.0%	2	1.3%	3	0.6%
男女合計	0	0.0%	0	0.0%	0	0.0%	0	0.0%	0	0.0%	0	0.0%	1	1.1%	3	1.0%	4	0.4%
全体(人)																		
男性	19		23		51		60		68		35		38		137		431	
女性	15		31		45		61		63		41		49		157		462	
男女合計	34		54		96		121		131		76		87		294		893	

全県 (60歳以上・再掲)

	64	割合	69	割合	70	割合	80	割合	90	割合	全体数	割合
1と回答												
男性	44	16.7%	60	21.1%	93	18.7%	57	21.0%	3	7.9%	257	19.0%
女性	93	35.8%	112	36.6%	200	39.3%	80	24.8%	12	14.5%	497	33.6%
男女合計	137	26.2%	172	29.1%	293	29.1%	137	23.1%	15	12.4%	754	26.6%
2と回答												
男性	218	82.9%	225	78.9%	400	80.5%	212	78.2%	35	92.1%	1090	80.5%
女性	164	63.1%	191	62.4%	299	58.7%	238	73.7%	70	84.3%	962	65.0%
男女合計	382	73.0%	416	70.4%	699	69.5%	450	75.8%	105	86.8%	2052	72.4%
無回答												
男性	1	0.4%	0	0.0%	4	0.8%	2	0.7%	0	0.0%	7	0.5%
女性	3	1.2%	3	1.0%	10	2.0%	5	1.5%	1	1.2%	22	1.5%
男女合計	4	0.8%	3	0.5%	14	1.4%	7	1.2%	1	0.8%	29	1.0%
全体(人)												
男性	263		285		497		271		38		1354	
女性	260		306		509		323		83		1481	
男女合計	523		591		1006		594		121		2835	

10 最近1年間の運動状況（調査票 問10）

（1）運動の状況

問10 最近1年間の運動について、あてはまるものを1つ選んで○をつけてください。

- 1 何らかの運動をほとんど毎日している。
- 2 何らかの運動を週2～4回程度している。
- 3 何らかの運動を週1回程度している。
- 4 ほとんど（まったく）していない。

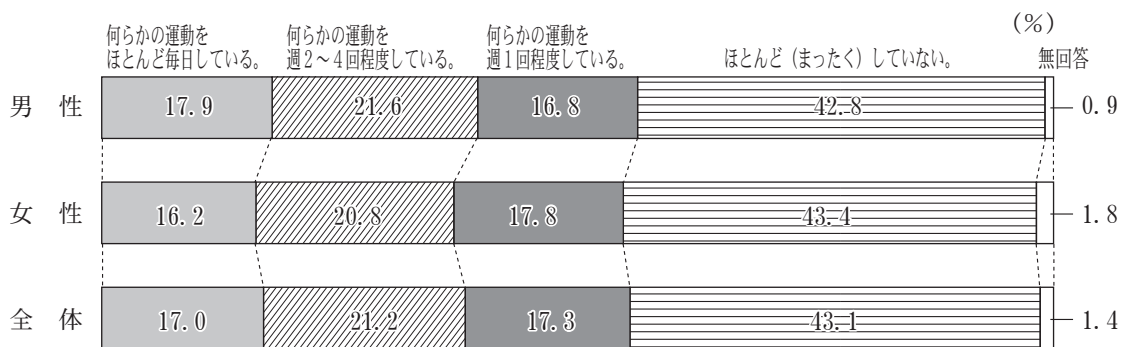

	10	割合	20	割合	30	割合	40	割合	50	割合	64	割合	69	割合	70	割合	80	割合	90	割合	全体数	割合
1と回答																						
男性	56	47.1%	23	13.9%	27	10.8%	41	11.0%	41	10.5%	36	13.7%	65	22.8%	111	22.3%	68	25.1%	8	21.1%	476	17.9%
女性	27	21.8%	14	7.8%	18	7.3%	35	10.3%	52	11.8%	35	13.5%	54	17.6%	122	24.0%	88	27.2%	11	13.3%	456	16.2%
男女合計	83	34.2%	37	10.7%	45	9.1%	76	10.6%	93	11.2%	71	13.6%	119	20.1%	233	23.2%	156	26.3%	19	15.7%	932	17.0%
2と回答																						
男性	25	21.0%	34	20.5%	43	17.1%	63	16.8%	70	17.9%	39	14.8%	69	24.2%	138	27.8%	82	30.3%	11	28.9%	574	21.6%
女性	37	29.8%	20	11.2%	35	14.2%	47	13.8%	75	17.0%	53	20.4%	81	26.5%	145	28.5%	78	24.1%	15	18.1%	586	20.8%
男女合計	62	25.5%	54	15.7%	78	15.7%	110	15.4%	145	17.4%	92	17.6%	150	25.4%	283	28.1%	160	26.9%	26	21.5%	1160	21.2%
3と回答																						
男性	13	10.9%	31	18.7%	57	22.7%	79	21.1%	73	18.6%	43	16.3%	46	16.1%	71	14.3%	29	10.7%	4	10.5%	446	16.8%
女性	23	18.5%	47	26.3%	41	16.7%	63	18.5%	86	19.5%	50	19.2%	66	21.6%	77	15.1%	36	11.1%	11	13.3%	500	17.8%
男女合計	36	14.8%	78	22.6%	98	19.7%	142	19.9%	159	19.1%	93	17.8%	112	19.0%	148	14.7%	65	10.9%	15	12.4%	946	17.3%
4と回答																						
男性	25	21.0%	78	47.0%	123	49.0%	190	50.8%	208	53.1%	145	55.1%	105	36.8%	164	33.0%	84	31.0%	14	36.8%	1136	42.8%
女性	37	29.8%	97	54.2%	152	61.8%	193	56.8%	225	51.0%	119	45.8%	98	32.0%	148	29.1%	105	32.5%	45	54.2%	1219	43.4%
男女合計	62	25.5%	175	50.7%	275	55.3%	383	53.6%	433	52.0%	264	50.5%	203	34.3%	312	31.0%	189	31.8%	59	48.8%	2355	43.1%
無回答																						
男性	0	0.0%	0	0.0%	1	0.4%	1	0.3%	0	0.0%	0	0.0%	0	0.0%	13	2.6%	8	3.0%	1	2.6%	24	0.9%
女性	0	0.0%	1	0.6%	0	0.0%	2	0.6%	3	0.7%	3	1.2%	7	2.3%	17	3.3%	16	5.0%	1	1.2%	50	1.8%
男女合計	0	0.0%	1	0.3%	1	0.2%	3	0.4%	3	0.4%	3	0.6%	7	1.2%	30	3.0%	24	4.0%	2	1.7%	74	1.4%
全体(人)																						
男性	119		166		251		374		392		263		285		497		271		38		2656	
女性	124		179		246		340		441		260		306		509		323		83		2811	
男女合計	243		345		497		714		833		523		591		1006		594		121		5467	

県 北

	10	割合	20	割合	30	割合	40	割合	50	割合	64	割合	69	割合	70～	割合	全体数	割合
1と回答																		
男性	14	40.0%	5	10.4%	12	13.0%	13	10.2%	12	10.2%	7	11.3%	15	25.4%	36	18.9%	114	15.6%
女性	10	27.0%	3	5.9%	10	11.4%	7	6.8%	16	11.9%	11	17.5%	14	17.1%	47	20.2%	118	14.9%
男女合計	24	33.3%	8	8.1%	22	12.2%	20	8.7%	28	11.1%	18	14.4%	29	20.6%	83	19.6%	232	15.2%
2と回答																		
男性	9	25.7%	11	22.9%	23	25.0%	26	20.3%	31	26.3%	9	14.5%	14	23.7%	48	25.3%	171	23.4%
女性	11	29.7%	4	7.8%	11	12.5%	13	12.6%	27	20.0%	12	19.0%	20	24.4%	62	26.6%	160	20.2%
男女合計	20	27.8%	15	15.2%	34	18.9%	39	16.9%	58	22.9%	21	16.8%	34	24.1%	110	26.0%	331	21.7%
3と回答																		
男性	4	11.4%	10	20.8%	13	14.1%	25	19.5%	17	14.4%	10	16.1%	7	11.9%	28	14.7%	114	15.6%
女性	6	16.2%	16	31.4%	9	10.2%	19	18.4%	27	20.0%	13	20.6%	22	26.8%	33	14.2%	145	18.3%
男女合計	10	13.9%	26	26.3%	22	12.2%	44	19.0%	44	17.4%	23	18.4%	29	20.6%	61	14.4%	259	17.0%
4と回答																		
男性	8	22.9%	22	45.8%	43	46.7%	63	49.2%	58	49.2%	36	58.1%	23	39.0%	75	39.5%	328	44.8%
女性	10	27.0%	28	54.9%	58	65.9%	64	62.1%	65	48.1%	26	41.3%	25	30.5%	81	34.8%	357	45.1%
男女合計	18	25.0%	50	50.5%	101	56.1%	127	55.0%	123	48.6%	62	49.6%	48	34.0%	156	36.9%	685	44.9%
無回答																		
男性	0	0.0%	0	0.0%	1	1.1%	1	0.8%	0	0.0%	0	0.0%	0	0.0%	3	1.6%	5	0.7%
女性	0	0.0%	0	0.0%	0	0.0%	0	0.0%	0	0.0%	1	1.6%	1	1.2%	10	4.3%	12	1.5%
男女合計	0	0.0%	0	0.0%	1	0.6%	1	0.4%	0	0.0%	1	0.8%	1	0.7%	13	3.1%	17	1.1%
全体(人)																		
男性	35		48		92		128		118		62		59		190		732	
女性	37		51		88		103		135		63		82		233		792	
男女合計	72		99		180		231		253		125		141		423		1524	

県 中

	10	割合	20	割合	30	割合	40	割合	50	割合	64	割合	69	割合	70～	割合	全体数	割合
1と回答																		
男性	17	51.5%	4	10.3%	7	14.6%	12	13.2%	9	8.3%	9	14.3%	16	20.8%	43	21.8%	117	17.8%
女性	9	31.0%	3	5.9%	4	7.1%	7	7.8%	9	8.7%	5	8.6%	9	13.2%	60	26.1%	106	15.5%
男女合計	26	41.9%	7	7.8%	11	10.6%	19	10.5%	18	8.5%	14	11.6%	25	17.2%	103	24.1%	223	16.6%
2と回答																		
男性	5	15.2%	9	23.1%	6	12.5%	14	15.4%	13	11.9%	13	20.6%	14	18.2%	63	32.0%	137	20.9%
女性	6	20.7%	7	13.7%	8	14.3%	16	17.8%	19	18.3%	9	15.5%	18	26.5%	60	26.1%	143	20.8%
男女合計	11	17.7%	16	17.8%	14	13.5%	30	16.6%	32	15.0%	22	18.2%	32	22.1%	123	28.8%	280	20.8%
3と回答																		
男性	3	9.1%	8	20.5%	15	31.3%	20	22.0%	21	19.3%	9	14.3%	18	23.4%	28	14.2%	122	18.6%
女性	5	17.2%	15	29.4%	9	16.1%	17	18.9%	18	17.3%	13	22.4%	13	19.1%	26	11.3%	116	16.9%
男女合計	8	12.9%	23	25.6%	24	23.1%	37	20.4%	39	18.3%	22	18.2%	31	21.4%	54	12.6%	238	17.7%
4と回答																		
男性	8	24.2%	18	46.2%	20	41.7%	45	49.5%	66	60.6%	32	50.8%	29	37.7%	58	29.4%	276	42.0%
女性	9	31.0%	26	51.0%	35	62.5%	50	55.6%	57	54.8%	31	53.4%	24	35.3%	75	32.6%	307	44.8%
男女合計	17	27.4%	44	48.9%	55	52.9%	95	52.5%	123	57.7%	63	52.1%	53	36.6%	133	31.1%	583	43.4%
無回答																		
男性	0	0.0%	0	0.0%	0	0.0%	0	0.0%	0	0.0%	0	0.0%	0	0.0%	5	2.5%	5	0.8%
女性	0	0.0%	0	0.0%	0	0.0%	0	0.0%	1	1.0%	0	0.0%	4	5.9%	9	3.9%	14	2.0%
男女合計	0	0.0%	0	0.0%	0	0.0%	0	0.0%	1	0.5%	0	0.0%	4	2.8%	14	3.3%	19	1.4%
全体(人)																		
男性	33		39		48		91		109		63		77		197		657	
女性	29		51		56		90		104		58		68		230		686	
男女合計	62		90		104		181		213		121		145		427		1343	

県 南

	10	割合	20	割合	30	割合	40	割合	50	割合	64	割合	69	割合	70～	割合	全体数	割合
1と回答																		
男性	2	28.6%	7	30.4%	1	4.5%	4	10.8%	4	11.8%	5	15.6%	9	27.3%	15	17.6%	47	17.2%
女性	4	21.1%	3	17.6%	1	5.6%	3	10.7%	6	13.0%	7	21.9%	6	20.7%	26	26.8%	56	19.6%
男女合計	6	23.1%	10	25.0%	2	5.0%	7	10.8%	10	12.5%	12	18.8%	15	24.2%	41	22.5%	103	18.4%
2と回答																		
男性	1	14.3%	3	13.0%	5	22.7%	4	10.8%	5	14.7%	5	15.6%	6	18.2%	30	35.3%	59	21.6%
女性	5	26.3%	2	11.8%	0	0.0%	5	17.9%	6	13.0%	10	31.3%	7	24.1%	20	20.6%	55	19.2%
男女合計	6	23.1%	5	12.5%	5	12.5%	9	13.8%	11	13.8%	15	23.4%	13	21.0%	50	27.5%	114	20.4%
3と回答																		
男性	1	14.3%	4	17.4%	5	22.7%	8	21.6%	8	23.5%	3	9.4%	5	15.2%	6	7.1%	40	14.7%
女性	2	10.5%	2	11.8%	4	22.2%	3	10.7%	7	15.2%	4	12.5%	7	24.1%	17	17.5%	46	16.1%
男女合計	3	11.5%	6	15.0%	9	22.5%	11	16.9%	15	18.8%	7	10.9%	12	19.4%	23	12.6%	86	15.4%
4と回答																		
男性	3	42.9%	9	39.1%	11	50.0%	21	56.8%	17	50.0%	19	59.4%	13	39.4%	32	37.6%	125	45.8%
女性	8	42.1%	10	58.8%	13	72.2%	17	60.7%	27	58.7%	9	28.1%	8	27.6%	31	32.0%	123	43.0%
男女合計	11	42.3%	19	47.5%	24	60.0%	38	58.5%	44	55.0%	28	43.8%	21	33.9%	63	34.6%	248	44.4%
無回答																		
男性	0	0.0%	0	0.0%	0	0.0%	0	0.0%	0	0.0%	0	0.0%	0	0.0%	2	2.4%	2	0.7%
女性	0	0.0%	0	0.0%	0	0.0%	0	0.0%	0	0.0%	2	6.3%	1	3.4%	3	3.1%	6	2.1%
男女合計	0	0.0%	0	0.0%	0	0.0%	0	0.0%	0	0.0%	2	3.1%	1	1.6%	5	2.7%	8	1.4%
全体(人)																		
男性	7		23		22		37		34		32		33		85		273	
女性	19		17		18		28		46		32		29		97		286	
男女合計	26		40		40		65		80		64		62		182		559	

会 津

	10	割合	20	割合	30	割合	40	割合	50	割合	64	割合	69	割合	70～	割合	全体数	割合
1と回答																		
男性	10	50.0%	2	7.1%	4	13.8%	3	8.8%	4	8.5%	3	6.0%	11	24.4%	25	25.5%	62	17.7%
女性	0	0.0%	2	9.5%	1	3.1%	7	20.6%	10	13.9%	4	9.3%	12	25.0%	25	21.7%	61	16.1%
男女合計	10	29.4%	4	8.2%	5	8.2%	10	14.7%	14	11.8%	7	7.5%	23	24.7%	50	23.5%	123	16.8%
2と回答																		
男性	4	20.0%	4	14.3%	1	3.4%	7	20.6%	10	21.3%	7	14.0%	12	26.7%	23	23.5%	68	19.4%
女性	7	50.0%	2	9.5%	1	3.1%	0	0.0%	11	15.3%	9	20.9%	9	18.8%	31	27.0%	70	18.5%
男女合計	11	32.4%	6	12.2%	2	3.3%	7	10.3%	21	17.6%	16	17.2%	21	22.6%	54	25.4%	138	18.9%
3と回答																		
男性	4	20.0%	6	21.4%	7	24.1%	11	32.4%	9	19.1%	12	24.0%	7	15.6%	16	16.3%	72	20.5%
女性	3	21.4%	5	23.8%	8	25.0%	3	8.8%	15	20.8%	10	23.3%	6	12.5%	19	16.5%	69	18.2%
男女合計	7	20.6%	11	22.4%	15	24.6%	14	20.6%	24	20.2%	22	23.7%	13	14.0%	35	16.4%	141	19.3%
4と回答																		
男性	2	10.0%	16	57.1%	17	58.6%	13	38.2%	24	51.1%	28	56.0%	15	33.3%	30	30.6%	145	41.3%
女性	4	28.6%	11	52.4%	22	68.8%	23	67.6%	36	50.0%	20	46.5%	21	43.8%	35	30.4%	172	45.4%
男女合計	6	17.6%	27	55.1%	39	63.9%	36	52.9%	60	50.4%	48	51.6%	36	38.7%	65	30.5%	317	43.4%
無回答																		
男性	0	0.0%	0	0.0%	0	0.0%	0	0.0%	0	0.0%	0	0.0%	0	0.0%	4	4.1%	4	1.1%
女性	0	0.0%	1	4.8%	0	0.0%	1	2.9%	0	0.0%	0	0.0%	0	0.0%	5	4.3%	7	1.8%
男女合計	0	0.0%	1	2.0%	0	0.0%	1	1.5%	0	0.0%	0	0.0%	0	0.0%	9	4.2%	11	1.5%
全体(人)																		
男性	20		28		29		34		47		50		45		98		351	
女性	14		21		32		34		72		43		48		115		379	
男女合計	34		49		61		68		119		93		93		213		730	

南 会 津

	10	割合	20	割合	30	割合	40	割合	50	割合	64	割合	69	割合	70～	割合	全体数	割合
1と回答																		
男性	0	0.0%	0	0.0%	0	0.0%	2	22.2%	1	14.3%	0	0.0%	1	16.7%	8	36.4%	12	23.1%
女性	0	0.0%	0	0.0%	0	0.0%	1	16.7%	1	25.0%	0	0.0%	1	14.3%	4	20.0%	7	14.9%
男女合計	0	0.0%	0	0.0%	0	0.0%	3	20.0%	2	18.2%	0	0.0%	2	15.4%	12	28.6%	19	19.2%
2と回答																		
男性	0	0.0%	1	33.3%	0	0.0%	0	0.0%	2	28.6%	0	0.0%	0	0.0%	6	27.3%	9	17.3%
女性	1	50.0%	1	50.0%	0	0.0%	1	16.7%	0	0.0%	3	60.0%	3	42.9%	5	25.0%	14	29.8%
男女合計	1	50.0%	2	40.0%	0	0.0%	1	6.7%	2	18.2%	3	42.9%	3	23.1%	11	26.2%	23	23.2%
3と回答																		
男性	0	0.0%	0	0.0%	2	66.7%	0	0.0%	1	14.3%	0	0.0%	0	0.0%	1	4.5%	4	7.7%
女性	1	50.0%	0	0.0%	0	0.0%	0	0.0%	1	25.0%	0	0.0%	1	14.3%	3	15.0%	6	12.8%
男女合計	1	50.0%	0	0.0%	2	50.0%	0	0.0%	2	18.2%	0	0.0%	1	7.7%	4	9.5%	10	10.1%
4と回答																		
男性	0	0.0%	2	66.7%	1	33.3%	7	77.8%	3	42.9%	2	100.0%	5	83.3%	5	22.7%	25	48.1%
女性	0	0.0%	1	50.0%	1	100.0%	4	66.7%	2	50.0%	2	40.0%	2	28.6%	8	40.0%	20	42.6%
男女合計	0	0.0%	3	60.0%	2	50.0%	11	73.3%	5	45.5%	4	57.1%	7	53.8%	13	31.0%	45	45.5%
無回答																		
男性	0	0.0%	0	0.0%	0	0.0%	0	0.0%	0	0.0%	0	0.0%	0	0.0%	2	9.1%	2	3.8%
女性	0	0.0%	0	0.0%	0	0.0%	0	0.0%	0	0.0%	0	0.0%	0	0.0%	0	0.0%	0	0.0%
男女合計	0	0.0%	0	0.0%	0	0.0%	0	0.0%	0	0.0%	0	0.0%	0	0.0%	2	4.8%	2	2.0%
全体(人)																		
男性	0		3		3		9		7		2		6		22		52	
女性	2		2		1		6		4		5		7		20		47	
男女合計	2		5		4		15		11		7		13		42		99	

相 双

	10	割合	20	割合	30	割合	40	割合	50	割合	64	割合	69	割合	70～	割合	全体数	割合
1と回答																		
男性	3	60.0%	0	0.0%	0	0.0%	2	13.3%	2	22.2%	7	36.8%	4	14.8%	20	26.0%	38	23.8%
女性	2	25.0%	0	0.0%	0	0.0%	2	11.1%	1	5.9%	7	38.9%	4	17.4%	14	22.2%	30	18.9%
男女合計	5	38.5%	0	0.0%	0	0.0%	4	12.1%	3	11.5%	14	37.8%	8	16.0%	34	24.3%	68	21.3%
2と回答																		
男性	2	40.0%	0	0.0%	1	16.7%	4	26.7%	2	22.2%	2	10.5%	11	40.7%	21	27.3%	43	26.9%
女性	2	25.0%	0	0.0%	3	50.0%	1	5.6%	1	5.9%	2	11.1%	14	60.9%	24	38.1%	47	29.6%
男女合計	4	30.8%	0	0.0%	4	33.3%	5	15.2%	3	11.5%	4	10.8%	25	50.0%	45	32.1%	90	28.2%
3と回答																		
男性	0	0.0%	0	0.0%	1	16.7%	4	26.7%	0	0.0%	2	10.5%	4	14.8%	9	11.7%	20	12.5%
女性	1	12.5%	2	33.3%	0	0.0%	5	27.8%	3	17.6%	2	11.1%	4	17.4%	3	4.8%	20	12.6%
男女合計	1	7.7%	2	25.0%	1	8.3%	9	27.3%	3	11.5%	4	10.8%	8	16.0%	12	8.6%	40	12.5%
4と回答																		
男性	0	0.0%	2	100.0%	4	66.7%	5	33.3%	5	55.6%	8	42.1%	8	29.6%	24	31.2%	56	35.0%
女性	3	37.5%	4	66.7%	3	50.0%	9	50.0%	11	64.7%	7	38.9%	1	4.3%	20	31.7%	58	36.5%
男女合計	3	23.1%	6	75.0%	7	58.3%	14	42.4%	16	61.5%	15	40.5%	9	18.0%	44	31.4%	114	35.7%
無回答																		
男性	0	0.0%	0	0.0%	0	0.0%	0	0.0%	0	0.0%	0	0.0%	0	0.0%	3	3.9%	3	1.9%
女性	0	0.0%	0	0.0%	0	0.0%	1	5.6%	1	5.9%	0	0.0%	0	0.0%	2	3.2%	4	2.5%
男女合計	0	0.0%	0	0.0%	0	0.0%	1	3.0%	1	3.8%	0	0.0%	0	0.0%	5	3.6%	7	2.2%
全体(人)																		
男性	5		2		6		15		9		19		27		77		160	
女性	8		6		6		18		17		18		23		63		159	
男女合計	13		8		12		33		26		37		50		140		319	

いわき

	10	割合	20	割合	30	割合	40	割合	50	割合	64	割合	69	割合	70～	割合	全体数	割合
1と回答																		
男性	10	52.6%	5	21.7%	3	5.9%	5	8.3%	9	13.2%	5	14.3%	9	23.7%	40	29.2%	86	20.0%
女性	2	13.3%	3	9.7%	2	4.4%	8	13.1%	9	14.3%	1	2.4%	8	16.3%	45	28.7%	78	16.9%
男女合計	12	35.3%	8	14.8%	5	5.2%	13	10.7%	18	13.7%	6	7.9%	17	19.5%	85	28.9%	164	18.4%
2と回答																		
男性	4	21.1%	6	26.1%	7	13.7%	8	13.3%	7	10.3%	3	8.6%	12	31.6%	40	29.2%	87	20.2%
女性	5	33.3%	4	12.9%	12	26.7%	11	18.0%	11	17.5%	8	19.5%	10	20.4%	36	22.9%	97	21.0%
男女合計	9	26.5%	10	18.5%	19	19.8%	19	15.7%	18	13.7%	11	14.5%	22	25.3%	76	25.9%	184	20.6%
3と回答																		
男性	1	5.3%	3	13.0%	14	27.5%	11	18.3%	17	25.0%	7	20.0%	5	13.2%	16	11.7%	74	17.2%
女性	5	33.3%	7	22.6%	11	24.4%	16	26.2%	15	23.8%	8	19.5%	13	26.5%	23	14.6%	98	21.2%
男女合計	6	17.6%	10	18.5%	25	26.0%	27	22.3%	32	24.4%	15	19.7%	18	20.7%	39	13.3%	172	19.3%
4と回答																		
男性	4	21.1%	9	39.1%	27	52.9%	36	60.0%	35	51.5%	20	57.1%	12	31.6%	38	27.7%	181	42.0%
女性	3	20.0%	17	54.8%	20	44.4%	26	42.6%	27	42.9%	24	58.5%	17	34.7%	48	30.6%	182	39.4%
男女合計	7	20.6%	26	48.1%	47	49.0%	62	51.2%	62	47.3%	44	57.9%	29	33.3%	86	29.3%	363	40.6%
無回答																		
男性	0	0.0%	0	0.0%	0	0.0%	0	0.0%	0	0.0%	0	0.0%	0	0.0%	3	2.2%	3	0.7%
女性	0	0.0%	0	0.0%	0	0.0%	0	0.0%	1	1.6%	0	0.0%	1	2.0%	5	3.2%	7	1.5%
男女合計	0	0.0%	0	0.0%	0	0.0%	0	0.0%	1	0.8%	0	0.0%	1	1.1%	8	2.7%	10	1.1%
全体(人)																		
男性	19		23		51		60		68		35		38		137		431	
女性	15		31		45		61		63		41		49		157		462	
男女合計	34		54		96		121		131		76		87		294		893	

全県(60歳以上・再掲)

	64	割合	69	割合	70	割合	80	割合	90	割合	全体数	割合
1と回答												
男性	36	13.7%	65	22.8%	111	22.3%	68	25.1%	8	21.1%	288	21.3%
女性	35	13.5%	54	17.6%	122	24.0%	88	27.2%	11	13.3%	310	20.9%
男女合計	71	13.6%	119	20.1%	233	23.2%	156	26.3%	19	15.7%	598	21.1%
2と回答												
男性	39	14.8%	69	24.2%	138	27.8%	82	30.3%	11	28.9%	339	25.0%
女性	53	20.4%	81	26.5%	145	28.5%	78	24.1%	15	18.1%	372	25.1%
男女合計	92	17.6%	150	25.4%	283	28.1%	160	26.9%	26	21.5%	711	25.1%
3と回答												
男性	43	16.3%	46	16.1%	71	14.3%	29	10.7%	4	10.5%	193	14.3%
女性	50	19.2%	66	21.6%	77	15.1%	36	11.1%	11	13.3%	240	16.2%
男女合計	93	17.8%	112	19.0%	148	14.7%	65	10.9%	15	12.4%	433	15.3%
4と回答												
男性	145	55.1%	105	36.8%	164	33.0%	84	31.0%	14	36.8%	512	37.8%
女性	119	45.8%	98	32.0%	148	29.1%	105	32.5%	45	54.2%	515	34.8%
男女合計	264	50.5%	203	34.3%	312	31.0%	189	31.8%	59	48.8%	1027	36.2%
無回答												
男性	0	0.0%	0	0.0%	13	2.6%	8	3.0%	1	2.6%	22	1.6%
女性	3	1.2%	7	2.3%	17	3.3%	16	5.0%	1	1.2%	44	3.0%
男女合計	3	0.6%	7	1.2%	30	3.0%	24	4.0%	2	1.7%	66	2.3%
全体(人)												
男性	263		285		497		271		38		1354	
女性	260		306		509		323		83		1481	
男女合計	523		591		1006		594		121		2835	

(2) 運動時間 (調査票 問10付問)

付問 問10で1～3を選んだ方におたずねします。1回の運動時間はどれくらいですか。
 複数の運動をしている方は、もっとも運動時間の長いものについてお答えください。

1 15分未満 2 15～30分未満 3 30分以上

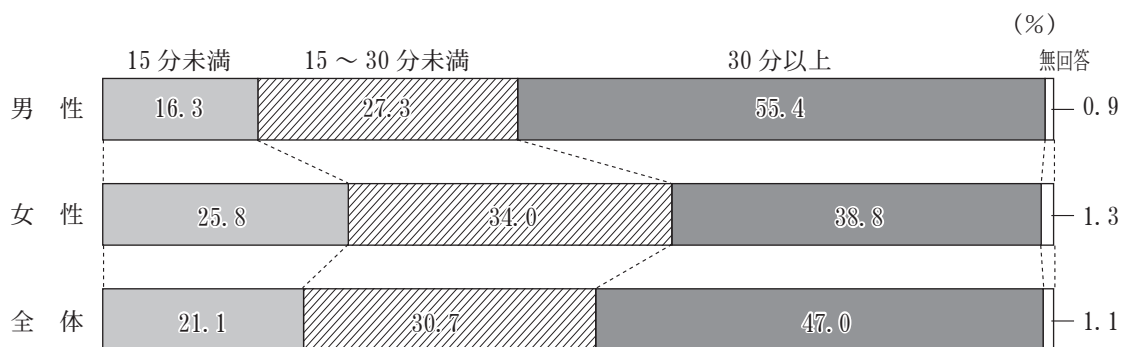

	10	割合	20	割合	30	割合	40	割合	50	割合	64	割合	69	割合	70	割合	80	割合	90	割合	全体数	割合
1と回答																						
男性	2	2.1%	14	15.9%	18	14.2%	24	13.1%	26	14.1%	24	20.3%	34	18.9%	54	16.9%	38	21.2%	10	43.5%	244	16.3%
女性	4	4.6%	14	17.3%	25	26.6%	30	20.7%	71	33.3%	37	26.8%	50	24.9%	80	23.3%	64	31.7%	23	62.2%	398	25.8%
男女合計	6	3.3%	28	16.6%	43	19.5%	54	16.5%	97	24.4%	61	23.8%	84	22.0%	134	20.2%	102	26.8%	33	55.0%	642	21.1%
2と回答																						
男性	14	14.9%	25	28.4%	36	28.3%	62	33.9%	60	32.6%	33	28.0%	49	27.2%	76	23.8%	49	27.4%	5	21.7%	409	27.3%
女性	25	28.7%	39	48.1%	43	45.7%	60	41.4%	67	31.5%	53	38.4%	62	30.8%	107	31.1%	61	30.2%	8	21.6%	525	34.0%
男女合計	39	21.5%	64	37.9%	79	35.7%	122	37.2%	127	32.0%	86	33.6%	111	29.1%	183	27.6%	110	28.9%	13	21.7%	934	30.7%
3と回答																						
男性	77	81.9%	48	54.5%	73	57.5%	97	53.0%	98	53.3%	59	50.0%	97	53.9%	186	58.1%	86	48.0%	8	34.8%	829	55.4%
女性	58	66.7%	28	34.6%	26	27.7%	55	37.9%	75	35.2%	48	34.8%	87	43.3%	149	43.3%	68	33.7%	5	13.5%	599	38.8%
男女合計	135	74.6%	76	45.0%	99	44.8%	152	46.3%	173	43.6%	107	41.8%	184	48.3%	335	50.5%	154	40.4%	13	21.7%	1428	47.0%
無回答																						
男性	1	1.1%	1	1.1%	0	0.0%	0	0.0%	0	0.0%	2	1.7%	0	0.0%	4	1.3%	6	3.4%	0	0.0%	14	0.9%
女性	0	0.0%	0	0.0%	0	0.0%	0	0.0%	0	0.0%	0	0.0%	2	1.0%	8	2.3%	9	4.5%	1	2.7%	20	1.3%
男女合計	1	0.6%	1	0.6%	0	0.0%	0	0.0%	0	0.0%	2	0.8%	2	0.5%	12	1.8%	15	3.9%	1	1.7%	34	1.1%
全体(人)																						
男性	94		88		127		183		184		118		180		320		179		23		1496	
女性	87		81		94		145		213		138		201		344		202		37		1542	
男女合計	181		169		221		328		397		256		381		664		381		60		3038	

県 北

	10	割合	20	割合	30	割合	40	割合	50	割合	64	割合	69	割合	70～	割合	全体数	割合	
1と回答																			
男性	1	3.7%	3	11.5%	7	14.6%	9	14.1%	9	15.0%	6	23.1%	7	19.4%	19	17.0%		61	15.3%
女性	1	3.7%	6	26.1%	8	26.7%	7	17.9%	22	31.4%	12	33.3%	14	25.0%	41	28.9%		111	26.2%
男女合計	2	3.7%	9	18.4%	15	19.2%	16	15.5%	31	23.8%	18	29.0%	21	22.8%	60	23.6%		172	20.9%
2と回答																			
男性	3	11.1%	9	34.6%	11	22.9%	26	40.6%	19	31.7%	8	30.8%	12	33.3%	35	31.3%		123	30.8%
女性	9	33.3%	10	43.5%	13	43.3%	15	38.5%	20	28.6%	16	44.4%	18	32.1%	40	28.2%		141	33.3%
男女合計	12	22.2%	19	38.8%	24	30.8%	41	39.8%	39	30.0%	24	38.7%	30	32.6%	75	29.5%		264	32.1%
3と回答																			
男性	23	85.2%	13	50.0%	30	62.5%	29	45.3%	32	53.3%	11	42.3%	17	47.2%	53	47.3%		208	52.1%
女性	17	63.0%	7	30.4%	9	30.0%	17	43.6%	28	40.0%	8	22.2%	24	42.9%	59	41.5%		169	40.0%
男女合計	40	74.1%	20	40.8%	39	50.0%	46	44.7%	60	46.2%	19	30.6%	41	44.6%	112	44.1%		377	45.9%
無回答																			
男性	0	0.0%	1	3.8%	0	0.0%	0	0.0%	0	0.0%	1	3.8%	0	0.0%	5	4.5%		7	1.8%
女性	0	0.0%	0	0.0%	0	0.0%	0	0.0%	0	0.0%	0	0.0%	0	0.0%	2	1.4%		2	0.5%
男女合計	0	0.0%	1	2.0%	0	0.0%	0	0.0%	0	0.0%	1	1.6%	0	0.0%	7	2.8%		9	1.1%
全体(人)																			
男性	27		26		48		64		60		26		36		112			399	
女性	27		23		30		39		70		36		56		142			423	
男女合計	54		49		78		103		130		62		92		254			822	

県 中

	10	割合	20	割合	30	割合	40	割合	50	割合	64	割合	69	割合	70～	割合	全体数	割合	
1と回答																			
男性	0	0.0%	4	19.0%	5	17.9%	6	13.0%	8	18.6%	7	22.6%	11	22.9%	24	17.9%		65	17.3%
女性	1	5.0%	2	8.0%	7	33.3%	8	20.0%	11	23.9%	6	22.2%	10	25.0%	31	21.2%		76	20.8%
男女合計	1	2.2%	6	13.0%	12	24.5%	14	16.3%	19	21.3%	13	22.4%	21	23.9%	55	19.6%		141	19.0%
2と回答																			
男性	3	12.0%	9	42.9%	9	32.1%	14	30.4%	15	34.9%	6	19.4%	14	29.2%	34	25.4%		104	27.7%
女性	6	30.0%	11	44.0%	12	57.1%	20	50.0%	15	32.6%	14	51.9%	11	27.5%	53	36.3%		142	38.9%
男女合計	9	20.0%	20	43.5%	21	42.9%	34	39.5%	30	33.7%	20	34.5%	25	28.4%	87	31.1%		246	33.2%
3と回答																			
男性	22	88.0%	8	38.1%	14	50.0%	26	56.5%	20	46.5%	17	54.8%	23	47.9%	74	55.2%		204	54.3%
女性	13	65.0%	12	48.0%	2	9.5%	12	30.0%	20	43.5%	7	25.9%	19	47.5%	61	41.8%		146	40.0%
男女合計	35	77.8%	20	43.5%	16	32.7%	38	44.2%	40	44.9%	24	41.4%	42	47.7%	135	48.2%		350	47.2%
無回答																			
男性	0	0.0%	0	0.0%	0	0.0%	0	0.0%	0	0.0%	1	3.2%	0	0.0%	2	1.5%		3	0.8%
女性	0	0.0%	0	0.0%	0	0.0%	0	0.0%	0	0.0%	0	0.0%	0	0.0%	1	0.7%		1	0.3%
男女合計	0	0.0%	0	0.0%	0	0.0%	0	0.0%	0	0.0%	1	1.7%	0	0.0%	3	1.1%		4	0.5%
全体(人)																			
男性	25		21		28		46		43		31		48		134			376	
女性	20		25		21		40		46		27		40		146			365	
男女合計	45		46		49		86		89		58		88		280			741	

県 南

	10	割合	20	割合	30	割合	40	割合	50	割合	64	割合	69	割合	70～	割合	全体数	割合	
1と回答																			
男性	0	0.0%	3	21.4%	1	9.1%	3	18.8%	2	11.8%	2	15.4%	1	5.0%	13	25.5%		25	17.1%
女性	1	9.1%	1	14.3%	3	60.0%	3	27.3%	10	52.6%	6	28.6%	9	45.0%	18	28.6%		51	32.5%
男女合計	1	6.7%	4	19.0%	4	25.0%	6	22.2%	12	33.3%	8	23.5%	10	25.0%	31	27.2%		76	25.1%
2と回答																			
男性	1	25.0%	1	7.1%	4	36.4%	3	18.8%	8	47.1%	6	46.2%	5	25.0%	11	21.6%		39	26.7%
女性	2	18.2%	3	42.9%	0	0.0%	4	36.4%	6	31.6%	5	23.8%	6	30.0%	18	28.6%		44	28.0%
男女合計	3	20.0%	4	19.0%	4	25.0%	7	25.9%	14	38.9%	11	32.4%	11	27.5%	29	25.4%		83	27.4%
3と回答																			
男性	3	75.0%	10	71.4%	6	54.5%	10	62.5%	7	41.2%	5	38.5%	14	70.0%	25	49.0%		80	54.8%
女性	8	72.7%	3	42.9%	2	40.0%	4	36.4%	3	15.8%	10	47.6%	5	25.0%	24	38.1%		59	37.6%
男女合計	11	73.3%	13	61.9%	8	50.0%	14	51.9%	10	27.8%	15	44.1%	19	47.5%	49	43.0%		139	45.9%
無回答																			
男性	0	0.0%	0	0.0%	0	0.0%	0	0.0%	0	0.0%	0	0.0%	0	0.0%	2	3.9%		2	1.4%
女性	0	0.0%	0	0.0%	0	0.0%	0	0.0%	0	0.0%	0	0.0%	0	0.0%	3	4.8%		3	1.9%
男女合計	0	0.0%	0	0.0%	0	0.0%	0	0.0%	0	0.0%	0	0.0%	0	0.0%	5	4.4%		5	1.7%
全体(人)																			
男性	4		14		11		16		17		13		20		51			146	
女性	11		7		5		11		19		21		20		63			157	
男女合計	15		21		16		27		36		34		40		114			303	

会 津

	10	割合	20	割合	30	割合	40	割合	50	割合	64	割合	69	割合	70～	割合	全体数	割合
1と回答																		
男性	1	5.6%	2	16.7%	2	16.7%	3	14.3%	1	4.3%	3	13.6%	7	23.3%	14	21.9%	33	16.3%
女性	0	0.0%	3	33.3%	1	10.0%	1	10.0%	15	41.7%	8	34.8%	6	22.2%	33	44.0%	67	33.5%
男女合計	1	3.6%	5	23.8%	3	13.6%	4	12.9%	16	27.1%	11	24.4%	13	22.8%	47	33.8%	100	24.9%
2と回答																		
男性	3	16.7%	3	25.0%	5	41.7%	7	33.3%	2	8.7%	6	27.3%	4	13.3%	17	26.6%	47	23.3%
女性	3	30.0%	4	44.4%	4	40.0%	5	50.0%	11	30.6%	8	34.8%	9	33.3%	23	30.7%	67	33.5%
男女合計	6	21.4%	7	33.3%	9	40.9%	12	38.7%	13	22.0%	14	31.1%	13	22.8%	40	28.8%	114	28.4%
3と回答																		
男性	14	77.8%	7	58.3%	5	41.7%	11	52.4%	20	87.0%	13	59.1%	19	63.3%	32	50.0%	121	59.9%
女性	7	70.0%	2	22.2%	5	50.0%	4	40.0%	10	27.8%	7	30.4%	12	44.4%	13	17.3%	60	30.0%
男女合計	21	75.0%	9	42.9%	10	45.5%	15	48.4%	30	50.8%	20	44.4%	31	54.4%	45	32.4%	181	45.0%
無回答																		
男性	0	0.0%	0	0.0%	0	0.0%	0	0.0%	0	0.0%	0	0.0%	0	0.0%	1	1.6%	1	0.5%
女性	0	0.0%	0	0.0%	0	0.0%	0	0.0%	0	0.0%	0	0.0%	0	0.0%	6	8.0%	6	3.0%
男女合計	0	0.0%	0	0.0%	0	0.0%	0	0.0%	0	0.0%	0	0.0%	0	0.0%	7	5.0%	7	1.7%
全体(人)																		
男性	18		12		12		21		23		22		30		64		202	
女性	10		9		10		10		36		23		27		75		200	
男女合計	28		21		22		31		59		45		57		139		402	

南 会 津

	10	割合	20	割合	30	割合	40	割合	50	割合	64	割合	69	割合	70～	割合	全体数	割合
1と回答																		
男性	0	0.0%	0	0.0%	0	0.0%	0	0.0%	1	25.0%	0	0.0%	0	0.0%	2	13.3%	3	12.0%
女性	0	0.0%	0	0.0%	0	0.0%	1	50.0%	1	50.0%	1	33.3%	1	20.0%	3	25.0%	7	25.9%
男女合計	0	0.0%	0	0.0%	0	0.0%	1	25.0%	2	33.3%	1	33.3%	1	16.7%	5	18.5%	10	19.2%
2と回答																		
男性	0	0.0%	0	0.0%	1	50.0%	0	0.0%	1	25.0%	0	0.0%	0	0.0%	2	13.3%	4	16.0%
女性	1	50.0%	0	0.0%	0	0.0%	0	0.0%	1	50.0%	1	33.3%	2	40.0%	3	25.0%	8	29.6%
男女合計	1	50.0%	0	0.0%	1	50.0%	0	0.0%	2	33.3%	1	33.3%	2	33.3%	5	18.5%	12	23.1%
3と回答																		
男性	0	0.0%	1	100.0%	1	50.0%	2	100.0%	2	50.0%	0	0.0%	1	100.0%	11	73.3%	18	72.0%
女性	1	50.0%	1	100.0%	0	0.0%	1	50.0%	0	0.0%	1	33.3%	2	40.0%	5	41.7%	11	40.7%
男女合計	1	50.0%	2	100.0%	1	50.0%	3	75.0%	2	33.3%	1	33.3%	3	50.0%	16	59.3%	29	55.8%
無回答																		
男性	0	0.0%	0	0.0%	0	0.0%	0	0.0%	0	0.0%	0	0.0%	0	0.0%	0	0.0%	0	0.0%
女性	0	0.0%	0	0.0%	0	0.0%	0	0.0%	0	0.0%	0	0.0%	0	0.0%	1	8.3%	1	3.7%
男女合計	0	0.0%	0	0.0%	0	0.0%	0	0.0%	0	0.0%	0	0.0%	0	0.0%	1	3.7%	1	1.9%
全体(人)																		
男性	0		1		2		2		4		0		1		15		25	
女性	2		1		0		2		2		3		5		12		27	
男女合計	2		2		2		4		6		3		6		27		52	

相 双

	10	割合	20	割合	30	割合	40	割合	50	割合	64	割合	69	割合	70～	割合	全体数	割合
1と回答																		
男性	0	0.0%	0	0.0%	0	0.0%	1	10.0%	0	0.0%	1	9.1%	1	5.3%	10	20.0%	13	12.9%
女性	0	0.0%	1	50.0%	0	0.0%	1	12.5%	1	20.0%	1	9.1%	2	9.1%	8	19.5%	14	14.4%
男女合計	0	0.0%	1	50.0%	0	0.0%	2	11.1%	1	11.1%	2	9.1%	3	7.3%	18	19.8%	27	13.6%
2と回答																		
男性	1	20.0%	0	0.0%	0	0.0%	5	50.0%	1	25.0%	3	27.3%	8	42.1%	8	16.0%	26	25.7%
女性	1	20.0%	1	50.0%	1	33.3%	5	62.5%	1	20.0%	4	36.4%	5	22.7%	12	29.3%	30	30.9%
男女合計	2	20.0%	1	50.0%	1	20.0%	10	55.6%	2	22.2%	7	31.8%	13	31.7%	20	22.0%	56	28.3%
3と回答																		
男性	4	80.0%	0	0.0%	2	100.0%	4	40.0%	3	75.0%	7	63.6%	10	52.6%	32	64.0%	62	61.4%
女性	4	80.0%	0	0.0%	2	66.7%	2	25.0%	3	60.0%	6	54.5%	15	68.2%	19	46.3%	51	52.6%
男女合計	8	80.0%	0	0.0%	4	80.0%	6	33.3%	6	66.7%	13	59.1%	25	61.0%	51	56.0%	113	57.1%
無回答																		
男性	0	0.0%	0	0.0%	0	0.0%	0	0.0%	0	0.0%	0	0.0%	0	0.0%	0	0.0%	0	0.0%
女性	0	0.0%	0	0.0%	0	0.0%	0	0.0%	0	0.0%	0	0.0%	0	0.0%	2	4.9%	2	2.1%
男女合計	0	0.0%	0	0.0%	0	0.0%	0	0.0%	0	0.0%	0	0.0%	0	0.0%	2	2.2%	2	1.0%
全体(人)																		
男性	5		0		2		10		4		11		19		50		101	
女性	5		2		3		8		5		11		22		41		97	
男女合計	10		2		5		18		9		22		41		91		198	

いわき

	10	割合	20	割合	30	割合	40	割合	50	割合	64	割合	69	割合	70～	割合	全体数	割合	
1と回答																			
男性	0	0.0%	2	14.3%	3	12.5%	2	8.3%	5	15.2%	5	33.3%	7	26.9%	20	20.8%		44	17.8%
女性	1	8.3%	1	7.1%	6	24.0%	9	25.7%	11	31.4%	3	17.6%	8	25.8%	33	31.7%		72	26.4%
男女合計	1	3.7%	3	10.7%	9	18.4%	11	18.6%	16	23.5%	8	25.0%	15	26.3%	53	26.5%		116	22.3%
2と回答																			
男性	3	20.0%	3	21.4%	6	25.0%	7	29.2%	14	42.4%	4	26.7%	6	23.1%	23	24.0%		66	26.7%
女性	3	25.0%	10	71.4%	13	52.0%	11	31.4%	13	37.1%	5	29.4%	11	35.5%	27	26.0%		93	34.1%
男女合計	6	22.2%	13	46.4%	19	38.8%	18	30.5%	27	39.7%	9	28.1%	17	29.8%	50	25.0%		159	30.6%
3と回答																			
男性	11	73.3%	9	64.3%	15	62.5%	15	62.5%	14	42.4%	6	40.0%	13	50.0%	53	55.2%		136	55.1%
女性	8	66.7%	3	21.4%	6	24.0%	15	42.9%	11	31.4%	9	52.9%	10	32.3%	41	39.4%		103	37.7%
男女合計	19	70.4%	12	42.9%	21	42.9%	30	50.8%	25	36.8%	15	46.9%	23	40.4%	94	47.0%		239	46.0%
無回答																			
男性	1	6.7%	0	0.0%	0	0.0%	0	0.0%	0	0.0%	0	0.0%	0	0.0%	0	0.0%		1	0.4%
女性	0	0.0%	0	0.0%	0	0.0%	0	0.0%	0	0.0%	0	0.0%	2	6.5%	3	2.9%		5	1.8%
男女合計	1	3.7%	0	0.0%	0	0.0%	0	0.0%	0	0.0%	0	0.0%	2	3.5%	3	1.5%		6	1.2%
全体(人)																			
男性	15		14		24		24		33		15		26		96			247	
女性	12		14		25		35		35		17		31		104			273	
男女合計	27		28		49		59		68		32		57		200			520	

全県(60歳以上・再掲)

	64	割合	69	割合	70	割合	80	割合	90	割合	全体数	割合	
1と回答													
男性	24	20.3%	34	18.9%	54	16.9%	38	21.2%	10	43.5%		160	19.5%
女性	37	26.8%	50	24.9%	80	23.3%	64	31.7%	23	62.2%		254	27.5%
男女合計	61	23.8%	84	22.0%	134	20.2%	102	26.8%	33	55.0%		414	23.8%
2と回答													
男性	33	28.0%	49	27.2%	76	23.8%	49	27.4%	5	21.7%		212	25.9%
女性	53	38.4%	62	30.8%	107	31.1%	61	30.2%	8	21.6%		291	31.6%
男女合計	86	33.6%	111	29.1%	183	27.6%	110	28.9%	13	21.7%		503	28.9%
3と回答													
男性	59	50.0%	97	53.9%	186	58.1%	86	48.0%	8	34.8%		436	53.2%
女性	48	34.8%	87	43.3%	149	43.3%	68	33.7%	5	13.5%		357	38.7%
男女合計	107	41.8%	184	48.3%	335	50.5%	154	40.4%	13	21.7%		793	45.5%
無回答													
男性	2	1.7%	0	0.0%	4	1.3%	6	3.4%	0	0.0%		12	1.5%
女性	0	0.0%	2	1.0%	8	2.3%	9	4.5%	1	2.7%		20	2.2%
男女合計	2	0.8%	2	0.5%	12	1.8%	15	3.9%	1	1.7%		32	1.8%
全体(人)													
男性	118		180		320		179		23		820		
女性	138		201		344		202		37		922		
男女合計	256		381		664		381		60		1742		

(3) 運動習慣の状況 (満20歳以上対象)

(「(1) 運動の状況」及び「(2) 運動時間」の回答に関するクロス集計)

	20	割合	30	割合	40	割合	50	割合	64	割合	69	割合	70	割合	80	割合	90	割合	全体数	割合
何らかの運動をほとんど毎日、15分未満している。																				
男性	3	1.8%	6	2.4%	6	1.6%	7	1.8%	8	3.0%	13	4.6%	14	2.8%	15	5.5%	1	2.6%	73	2.9%
女性	2	1.1%	3	1.2%	8	2.4%	21	4.8%	7	2.7%	15	4.9%	24	4.7%	29	9.0%	7	8.4%	116	4.3%
男女合計	5	1.4%	9	1.8%	14	2.0%	28	3.4%	15	2.9%	28	4.7%	38	3.8%	44	7.4%	8	6.6%	189	3.6%
何らかの運動をほとんど毎日、15～30分未満している。																				
男性	5	3.0%	5	2.0%	13	3.5%	12	3.1%	6	2.3%	17	6.0%	21	4.2%	17	6.3%	3	7.9%	99	3.9%
女性	5	2.8%	9	3.7%	12	3.5%	15	3.4%	13	5.0%	15	4.9%	46	9.0%	25	7.7%	2	2.4%	142	5.3%
男女合計	10	2.9%	14	2.8%	25	3.5%	27	3.2%	19	3.6%	32	5.4%	67	6.7%	42	7.1%	5	4.1%	241	4.6%
何らかの運動をほとんど毎日、30分以上している。																				
男性	15	9.0%	16	6.4%	22	5.9%	22	5.6%	21	8.0%	35	12.3%	76	15.3%	36	13.3%	4	10.5%	247	9.7%
女性	7	3.9%	6	2.4%	15	4.4%	16	3.6%	15	5.8%	23	7.5%	50	9.8%	32	9.9%	2	2.4%	166	6.2%
男女合計	22	6.4%	22	4.4%	37	5.2%	38	4.6%	36	6.9%	58	9.8%	126	12.5%	68	11.4%	6	5.0%	413	7.9%
何らかの運動をほとんど毎日している。(時間無回答)																				
男性	0	0.0%	0	0.0%	0	0.0%	0	0.0%	1	0.4%	0	0.0%	0	0.0%	0	0.0%	0	0.0%	1	0.0%
女性	0	0.0%	0	0.0%	0	0.0%	0	0.0%	0	0.0%	1	0.3%	2	0.4%	2	0.6%	0	0.0%	5	0.2%
男女合計	0	0.0%	0	0.0%	0	0.0%	0	0.0%	1	0.2%	1	0.2%	2	0.2%	2	0.3%	0	0.0%	6	0.1%
何らかの運動を週2～4回程度、15分未満している。																				
男性	3	1.8%	5	2.0%	10	2.7%	7	1.8%	7	2.7%	9	3.2%	19	3.8%	12	4.4%	7	18.4%	79	3.1%
女性	1	0.6%	11	4.5%	11	3.2%	23	5.2%	9	3.5%	15	4.9%	32	6.3%	20	6.2%	9	10.8%	131	4.9%
男女合計	4	1.2%	16	3.2%	21	2.9%	30	3.6%	16	3.1%	24	4.1%	51	5.1%	32	5.4%	16	13.2%	210	4.0%
何らかの運動を週2～4回程度、15～30分未満している。																				
男性	10	6.0%	10	4.0%	23	6.1%	24	6.1%	11	4.2%	19	6.7%	35	7.0%	25	9.2%	2	5.3%	159	6.3%
女性	11	6.1%	17	6.9%	14	4.1%	23	5.2%	23	8.8%	26	8.5%	43	8.4%	27	8.4%	5	6.0%	189	7.0%
男女合計	21	6.1%	27	5.4%	37	5.2%	47	5.6%	34	6.5%	45	7.6%	78	7.8%	52	8.8%	7	5.8%	348	6.7%
何らかの運動を週2～4回程度、30分以上している。																				
男性	20	12.0%	28	11.2%	30	8.0%	39	9.9%	20	7.6%	41	14.4%	81	16.3%	40	14.8%	2	5.3%	301	11.9%
女性	8	4.5%	7	2.8%	22	6.5%	29	6.6%	21	8.1%	39	12.7%	65	12.8%	27	8.4%	0	0.0%	218	8.1%
男女合計	28	8.1%	35	7.0%	52	7.3%	68	8.2%	41	7.8%	80	13.5%	146	14.5%	67	11.3%	2	1.7%	519	9.9%
何らかの運動を週2～4回程度している。(時間無回答)																				
男性	1	0.6%	0	0.0%	0	0.0%	0	0.0%	1	0.4%	0	0.0%	3	0.6%	5	1.8%	0	0.0%	10	0.4%
女性	0	0.0%	0	0.0%	0	0.0%	0	0.0%	0	0.0%	1	0.3%	5	1.0%	4	1.2%	1	1.2%	11	0.4%
男女合計	1	0.3%	0	0.0%	0	0.0%	0	0.0%	1	0.2%	1	0.2%	8	0.8%	9	1.5%	1	0.8%	21	0.4%
何らかの運動を週1回程度、15分未満している。																				
男性	8	4.8%	7	2.8%	8	2.1%	12	3.1%	9	3.4%	12	4.2%	21	4.2%	11	4.1%	2	5.3%	90	3.5%
女性	11	6.1%	11	4.5%	11	3.2%	27	6.1%	21	8.1%	20	6.5%	24	4.7%	15	4.6%	7	8.4%	147	5.5%
男女合計	19	5.5%	18	3.6%	19	2.7%	39	4.7%	30	5.7%	32	5.4%	45	4.5%	26	4.4%	9	7.4%	237	4.5%
何らかの運動を週1回程度、15～30分未満している。																				
男性	10	6.0%	21	8.4%	26	7.0%	24	6.1%	16	6.1%	13	4.6%	20	4.0%	7	2.6%	0	0.0%	137	5.4%
女性	23	12.8%	17	6.9%	34	10.0%	29	6.6%	17	6.5%	21	6.9%	18	3.5%	9	2.8%	1	1.2%	169	6.3%
男女合計	33	9.6%	38	7.6%	60	8.4%	53	6.4%	33	6.3%	34	5.8%	38	3.8%	16	2.7%	1	0.8%	306	5.9%
何らかの運動を週1回程度、30分以上している。																				
男性	13	7.8%	29	11.6%	45	12.0%	37	9.4%	18	6.8%	21	7.4%	29	5.8%	10	3.7%	2	5.3%	204	8.0%
女性	13	7.3%	13	5.3%	18	5.3%	30	6.8%	12	4.6%	25	8.2%	34	6.7%	9	2.8%	3	3.6%	157	5.8%
男女合計	26	7.5%	42	8.5%	63	8.8%	67	8.0%	30	5.7%	46	7.8%	63	6.3%	19	3.2%	5	4.1%	361	6.9%
何らかの運動を週1回程度している。(時間無回答)																				
男性	0	0.0%	0	0.0%	0	0.0%	0	0.0%	0	0.0%	0	0.0%	1	0.2%	1	0.4%	0	0.0%	2	0.1%
女性	0	0.0%	0	0.0%	0	0.0%	0	0.0%	0	0.0%	0	0.0%	1	0.2%	3	0.9%	0	0.0%	4	0.1%
男女合計	0	0.0%	0	0.0%	0	0.0%	0	0.0%	0	0.0%	0	0.0%	2	0.2%	4	0.7%	0	0.0%	6	0.1%
ほとんど(まったく)していない。																				
男性	78	47.0%	123	49.0%	190	50.8%	208	53.1%	145	55.1%	105	36.8%	164	33.0%	84	31.0%	14	36.8%	1111	43.8%
女性	97	54.2%	152	61.8%	193	56.8%	225	51.0%	119	45.8%	98	32.0%	148	29.1%	105	32.5%	45	54.2%	1182	44.0%
男女合計	175	50.7%	275	55.3%	383	53.6%	433	52.0%	264	50.5%	203	34.3%	312	31.0%	189	31.8%	59	48.8%	2293	43.9%
無回答																				
男性	0	0.0%	1	0.4%	1	0.3%	0	0.0%	0	0.0%	0	0.0%	13	2.6%	8	3.0%	1	2.6%	24	0.9%
女性	1	0.6%	0	0.0%	2	0.6%	3	0.7%	3	1.2%	7	2.3%	17	3.3%	16	5.0%	1	1.2%	50	1.9%
男女合計	1	0.3%	1	0.2%	3	0.4%	3	0.4%	3	0.6%	7	1.2%	30	3.0%	24	4.0%	2	1.7%	74	1.4%
全体(人)																				
男性	166		251		374		392		263		285		497		271		38		2537	
女性	179		246		340		441		260		306		509		323		83		2687	
男女合計	345		497		714		833		523		591		1006		594		121		5224	

11 喫煙の状況

(1) 喫煙の有無 (満20歳以上対象) (調査票 問11)

問11 あなたは、たばこを吸っていますか。(あてはまる番号1つに○)

- 1 毎日吸う
- 2 時々吸う
- 3 今は吸っていない
- 4 習慣的に吸ったことがない

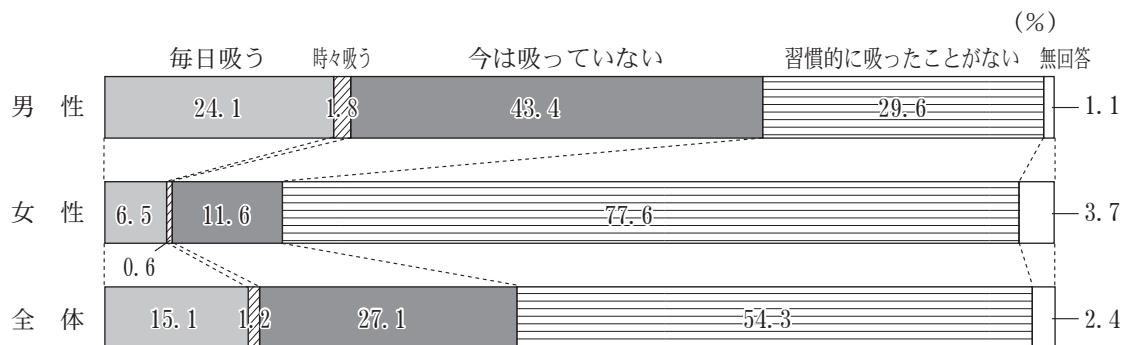

	20	割合	30	割合	40	割合	50	割合	64	割合	69	割合	70	割合	80	割合	90	割合	全体数	割合
1と回答																				
男性	37	22.3%	86	34.3%	134	35.8%	138	35.2%	63	24.0%	59	20.7%	76	15.3%	17	6.3%	2	5.3%	612	24.1%
女性	11	6.1%	23	9.3%	38	11.2%	45	10.2%	26	10.0%	17	5.6%	12	2.4%	1	0.3%	2	2.4%	175	6.5%
男女合計	48	13.9%	109	21.9%	172	24.1%	183	22.0%	89	17.0%	76	12.9%	88	8.7%	18	3.0%	4	3.3%	787	15.1%
2と回答																				
男性	7	4.2%	6	2.4%	9	2.4%	7	1.8%	6	2.3%	5	1.8%	6	1.2%	0	0.0%	0	0.0%	46	1.8%
女性	3	1.7%	1	0.4%	3	0.9%	2	0.5%	3	1.2%	0	0.0%	3	0.6%	0	0.0%	0	0.0%	15	0.6%
男女合計	10	2.9%	7	1.4%	12	1.7%	9	1.1%	9	1.7%	5	0.8%	9	0.9%	0	0.0%	0	0.0%	61	1.2%
3と回答																				
男性	5	3.0%	45	17.9%	119	31.8%	156	39.8%	126	47.9%	164	57.5%	309	62.2%	153	56.5%	25	65.8%	1102	43.4%
女性	5	2.8%	36	14.6%	75	22.1%	48	10.9%	31	11.9%	27	8.8%	52	10.2%	31	9.6%	8	9.6%	313	11.6%
男女合計	10	2.9%	81	16.3%	194	27.2%	204	24.5%	157	30.0%	191	32.3%	361	35.9%	184	31.0%	33	27.3%	1415	27.1%
4と回答																				
男性	117	70.5%	113	45.0%	106	28.3%	91	23.2%	67	25.5%	55	19.3%	98	19.7%	92	33.9%	11	28.9%	750	29.6%
女性	160	89.4%	184	74.8%	221	65.0%	341	77.3%	196	75.4%	256	83.7%	406	79.8%	251	77.7%	70	84.3%	2085	77.6%
男女合計	277	80.3%	297	59.8%	327	45.8%	432	51.9%	263	50.3%	311	52.6%	504	50.1%	343	57.7%	81	66.9%	2835	54.3%
無回答																				
男性	0	0.0%	1	0.4%	6	1.6%	0	0.0%	1	0.4%	2	0.7%	8	1.6%	9	3.3%	0	0.0%	27	1.1%
女性	0	0.0%	2	0.8%	3	0.9%	5	1.1%	4	1.5%	6	2.0%	36	7.1%	40	12.4%	3	3.6%	99	3.7%
男女合計	0	0.0%	3	0.6%	9	1.3%	5	0.6%	5	1.0%	8	1.4%	44	4.4%	49	8.2%	3	2.5%	126	2.4%
全体(人)																				
男性	166		251		374		392		263		285		497		271		38		2537	
女性	179		246		340		441		260		306		509		323		83		2687	
男女合計	345		497		714		833		523		591		1006		594		121		5224	

県 北

	20	割合	30	割合	40	割合	50	割合	64	割合	69	割合	70～	割合	全体数	割合
1と回答																
男性	11	22.9%	31	33.7%	36	28.1%	38	32.2%	15	24.2%	8	13.6%	28	14.7%	167	24.0%
女性	3	5.9%	6	6.8%	12	11.7%	10	7.4%	8	12.7%	6	7.3%	6	2.6%	51	6.8%
男女合計	14	14.1%	37	20.6%	48	20.8%	48	19.0%	23	18.4%	14	9.9%	34	8.0%	218	15.0%
2と回答																
男性	3	6.3%	2	2.2%	4	3.1%	1	0.8%	2	3.2%	0	0.0%	1	0.5%	13	1.9%
女性	1	2.0%	0	0.0%	1	1.0%	1	0.7%	1	1.6%	0	0.0%	0	0.0%	4	0.5%
男女合計	4	4.0%	2	1.1%	5	2.2%	2	0.8%	3	2.4%	0	0.0%	1	0.2%	17	1.2%
3と回答																
男性	2	4.2%	14	15.2%	45	35.2%	42	35.6%	30	48.4%	36	61.0%	106	55.8%	275	39.5%
女性	1	2.0%	8	9.1%	23	22.3%	14	10.4%	5	7.9%	10	12.2%	17	7.3%	78	10.3%
男女合計	3	3.0%	22	12.2%	68	29.4%	56	22.1%	35	28.0%	46	32.6%	123	29.1%	353	24.3%
4と回答																
男性	32	66.7%	45	48.9%	41	32.0%	37	31.4%	15	24.2%	15	25.4%	48	25.3%	233	33.4%
女性	46	90.2%	74	84.1%	66	64.1%	108	80.0%	48	76.2%	65	79.3%	198	85.0%	605	80.1%
男女合計	78	78.8%	119	66.1%	107	46.3%	145	57.3%	63	50.4%	80	56.7%	246	58.2%	838	57.7%
無回答																
男性	0	0.0%	0	0.0%	2	1.6%	0	0.0%	0	0.0%	0	0.0%	7	3.7%	9	1.3%
女性	0	0.0%	0	0.0%	1	1.0%	2	1.5%	1	1.6%	1	1.2%	12	5.2%	17	2.3%
男女合計	0	0.0%	0	0.0%	3	1.3%	2	0.8%	1	0.8%	1	0.7%	19	4.5%	26	1.8%
全体(人)																
男性	48		92		128		118		62		59		190		697	
女性	51		88		103		135		63		82		233		755	
男女合計	99		180		231		253		125		141		423		1452	

県 中

	20	割合	30	割合	40	割合	50	割合	64	割合	69	割合	70～	割合	全体数	割合
1と回答																
男性	5	12.8%	13	27.1%	37	40.7%	49	45.0%	19	30.2%	17	22.1%	28	14.2%	168	26.9%
女性	1	2.0%	4	7.1%	15	16.7%	13	12.5%	11	19.0%	0	0.0%	3	1.3%	47	7.2%
男女合計	6	6.7%	17	16.3%	52	28.7%	62	29.1%	30	24.8%	17	11.7%	31	7.3%	215	16.8%
2と回答																
男性	3	7.7%	2	4.2%	2	2.2%	2	1.8%	3	4.8%	3	3.9%	2	1.0%	17	2.7%
女性	1	2.0%	0	0.0%	1	1.1%	1	1.0%	0	0.0%	0	0.0%	0	0.0%	3	0.5%
男女合計	4	4.4%	2	1.9%	3	1.7%	3	1.4%	3	2.5%	3	2.1%	2	0.5%	20	1.6%
3と回答																
男性	1	2.6%	11	22.9%	23	25.3%	39	35.8%	24	38.1%	42	54.5%	118	59.9%	258	41.3%
女性	1	2.0%	12	21.4%	21	23.3%	10	9.6%	6	10.3%	6	8.8%	30	13.0%	86	13.1%
男女合計	2	2.2%	23	22.1%	44	24.3%	49	23.0%	30	24.8%	48	33.1%	148	34.7%	344	26.9%
4と回答																
男性	30	76.9%	21	43.8%	29	31.9%	19	17.4%	17	27.0%	13	16.9%	46	23.4%	175	28.0%
女性	48	94.1%	39	69.6%	53	58.9%	79	76.0%	39	67.2%	61	89.7%	178	77.4%	497	75.6%
男女合計	78	86.7%	60	57.7%	82	45.3%	98	46.0%	56	46.3%	74	51.0%	224	52.5%	672	52.5%
無回答																
男性	0	0.0%	1	2.1%	0	0.0%	0	0.0%	0	0.0%	2	2.6%	3	1.5%	6	1.0%
女性	0	0.0%	1	1.8%	0	0.0%	1	1.0%	2	3.4%	1	1.5%	19	8.3%	24	3.7%
男女合計	0	0.0%	2	1.9%	0	0.0%	1	0.5%	2	1.7%	3	2.1%	22	5.2%	30	2.3%
全体(人)																
男性	39		48		91		109		63		77		197		624	
女性	51		56		90		104		58		68		230		657	
男女合計	90		104		181		213		121		145		427		1281	

県 南

	20	割合	30	割合	40	割合	50	割合	64	割合	69	割合	70～	割合	全体数	割合
1と回答																
男性	9	39.1%	13	59.1%	16	43.2%	13	38.2%	6	18.8%	4	12.1%	10	11.8%	71	26.7%
女性	0	0.0%	3	16.7%	1	3.6%	4	8.7%	1	3.1%	1	3.4%	3	3.1%	13	4.9%
男女合計	9	22.5%	16	40.0%	17	26.2%	17	21.3%	7	10.9%	5	8.1%	13	7.1%	84	15.8%
2と回答																
男性	0	0.0%	0	0.0%	1	2.7%	0	0.0%	0	0.0%	0	0.0%	0	0.0%	1	0.4%
女性	0	0.0%	0	0.0%	0	0.0%	0	0.0%	0	0.0%	0	0.0%	1	1.0%	1	0.4%
男女合計	0	0.0%	0	0.0%	1	1.5%	0	0.0%	0	0.0%	0	0.0%	1	0.5%	2	0.4%
3と回答																
男性	1	4.3%	3	13.6%	14	37.8%	15	44.1%	20	62.5%	18	54.5%	49	57.6%	120	45.1%
女性	0	0.0%	1	5.6%	2	7.1%	6	13.0%	3	9.4%	2	6.9%	11	11.3%	25	9.4%
男女合計	1	2.5%	4	10.0%	16	24.6%	21	26.3%	23	35.9%	20	32.3%	60	33.0%	145	27.2%
4と回答																
男性	13	56.5%	6	27.3%	5	13.5%	6	17.6%	6	18.8%	11	33.3%	25	29.4%	72	27.1%
女性	17	100.0%	14	77.8%	25	89.3%	35	76.1%	28	87.5%	24	82.8%	71	73.2%	214	80.1%
男女合計	30	75.0%	20	50.0%	30	46.2%	41	51.3%	34	53.1%	35	56.5%	96	52.7%	286	53.7%
無回答																
男性	0	0.0%	0	0.0%	1	2.7%	0	0.0%	0	0.0%	0	0.0%	1	1.2%	2	0.8%
女性	0	0.0%	0	0.0%	0	0.0%	1	2.2%	0	0.0%	2	6.9%	11	11.3%	14	5.2%
男女合計	0	0.0%	0	0.0%	1	1.5%	1	1.3%	0	0.0%	2	3.2%	12	6.6%	16	3.0%
全体(人)																
男性	23		22		37		34		32		33		85		266	
女性	17		18		28		46		32		29		97		267	
男女合計	40		40		65		80		64		62		182		533	

会 津

	20	割合	30	割合	40	割合	50	割合	64	割合	69	割合	70～	割合	全体数	割合
1と回答	7	25.0%	7	24.1%	21	61.8%	13	27.7%	13	26.0%	11	24.4%	7	7.1%	79	23.9%
男性	3	14.3%	3	9.4%	4	11.8%	7	9.7%	3	7.0%	5	10.4%	0	0.0%	25	6.8%
女性	4	10.7%	4	12.5%	17	50.0%	6	18.0%	10	30.0%	6	18.0%	7	21.0%	54	17.1%
男女合計	10	20.4%	10	16.4%	25	36.8%	20	16.8%	16	17.2%	16	17.2%	7	3.3%	104	14.9%
2と回答	0	0.0%	1	3.4%	2	5.9%	1	2.1%	1	2.0%	1	2.2%	1	1.0%	7	2.1%
男性	1	4.8%	0	0.0%	1	2.9%	0	0.0%	1	2.3%	0	0.0%	1	0.9%	4	1.1%
女性	0	0.0%	1	1.6%	1	1.6%	1	1.6%	0	0.0%	1	1.1%	0	0.0%	3	0.8%
男女合計	1	2.0%	1	1.6%	3	4.4%	1	0.8%	2	2.2%	1	1.1%	2	0.9%	11	1.6%
3と回答	0	0.0%	6	20.7%	7	20.6%	21	44.7%	26	52.0%	30	66.7%	62	63.3%	152	45.9%
男性	1	4.8%	4	12.5%	9	26.5%	10	13.9%	7	16.3%	2	4.2%	12	10.4%	45	12.3%
女性	0	0.0%	2	6.2%	2	6.2%	11	33.3%	19	57.6%	28	83.3%	50	15.3%	107	33.6%
男女合計	1	2.0%	10	16.4%	16	23.5%	31	26.1%	33	35.5%	32	34.4%	74	34.7%	197	28.3%
4と回答	21	75.0%	15	51.7%	4	11.8%	12	25.5%	10	20.0%	3	6.7%	27	27.6%	92	27.8%
男性	16	76.2%	24	75.0%	20	58.8%	55	76.4%	31	72.1%	40	83.3%	89	77.4%	275	75.3%
女性	5	18.8%	11	38.3%	16	53.3%	17	55.0%	9	27.9%	7	21.2%	18	55.6%	117	36.5%
男女合計	37	75.5%	39	63.9%	24	35.3%	67	56.3%	41	44.1%	43	46.2%	116	54.5%	367	52.7%
無回答	0	0.0%	0	0.0%	0	0.0%	0	0.0%	0	0.0%	0	0.0%	1	1.0%	1	0.3%
男性	0	0.0%	1	3.1%	0	0.0%	0	0.0%	1	2.3%	1	2.1%	13	11.3%	16	4.4%
女性	0	0.0%	0	0.0%	0	0.0%	0	0.0%	0	0.0%	0	0.0%	0	0.0%	0	0.0%
男女合計	0	0.0%	1	1.6%	0	0.0%	0	0.0%	1	1.1%	1	1.1%	14	6.6%	17	2.4%
全体(人)	28		29		34		47		50		45		98		331	
男性	21		32		34		72		43		48		115		365	
女性	7		0		0		0		7		0		0		0	
男女合計	49		61		68		119		93		93		213		696	

南 会 津

	20	割合	30	割合	40	割合	50	割合	64	割合	69	割合	70～	割合	全体数	割合
1と回答	0	0.0%	1	33.3%	2	22.2%	3	42.9%	0	0.0%	4	66.7%	2	9.1%	12	23.1%
男性	1	50.0%	1	100.0%	0	0.0%	2	50.0%	0	0.0%	2	28.6%	0	0.0%	6	13.3%
女性	0	0.0%	0	0.0%	2	100.0%	1	50.0%	0	0.0%	2	100.0%	2	100.0%	6	100.0%
男女合計	1	20.0%	2	50.0%	2	13.3%	5	45.5%	0	0.0%	6	46.2%	2	4.8%	18	18.6%
2と回答	0	0.0%	1	33.3%	0	0.0%	1	14.3%	0	0.0%	0	0.0%	1	4.5%	3	5.8%
男性	0	0.0%	0	0.0%	0	0.0%	0	0.0%	0	0.0%	0	0.0%	0	0.0%	0	0.0%
女性	0	0.0%	1	25.0%	0	0.0%	1	9.1%	0	0.0%	0	0.0%	1	2.4%	3	3.1%
男女合計	0	0.0%	1	25.0%	0	0.0%	1	9.1%	0	0.0%	0	0.0%	1	2.4%	3	3.1%
3と回答	1	33.3%	0	0.0%	4	44.4%	2	28.6%	1	50.0%	0	0.0%	11	50.0%	19	36.5%
男性	0	0.0%	0	0.0%	1	16.7%	1	25.0%	0	0.0%	0	0.0%	3	15.0%	5	11.1%
女性	1	20.0%	0	0.0%	5	33.3%	3	27.3%	1	14.3%	0	0.0%	14	33.3%	24	24.7%
男女合計	1	20.0%	0	0.0%	5	33.3%	3	27.3%	1	14.3%	0	0.0%	14	33.3%	24	24.7%
4と回答	2	66.7%	1	33.3%	1	11.1%	1	14.3%	1	50.0%	2	33.3%	6	27.3%	14	26.9%
男性	1	50.0%	0	0.0%	5	83.3%	1	25.0%	5	100.0%	5	71.4%	16	80.0%	33	73.3%
女性	1	33.3%	1	33.3%	0	0.0%	0	0.0%	0	0.0%	0	0.0%	0	0.0%	11	24.7%
男女合計	3	60.0%	1	25.0%	6	40.0%	2	18.2%	6	85.7%	7	53.8%	22	52.4%	47	48.5%
無回答	0	0.0%	0	0.0%	2	22.2%	0	0.0%	0	0.0%	0	0.0%	2	9.1%	4	7.7%
男性	0	0.0%	0	0.0%	0	0.0%	0	0.0%	0	0.0%	0	0.0%	1	5.0%	1	2.2%
女性	0	0.0%	0	0.0%	2	100.0%	0	0.0%	0	0.0%	0	0.0%	1	5.0%	3	3.1%
男女合計	0	0.0%	0	0.0%	2	13.3%	0	0.0%	0	0.0%	0	0.0%	3	7.1%	5	5.2%
全体(人)	3		3		9		7		2		6		22		52	
男性	2		1		6		4		5		7		20		45	
女性	1		2		3		3		0		0		2		7	
男女合計	5		4		15		11		7		13		42		97	

相 双

	20	割合	30	割合	40	割合	50	割合	64	割合	69	割合	70～	割合	全体数	割合
1と回答	0	0.0%	2	33.3%	4	26.7%	4	44.4%	2	10.5%	4	14.8%	7	9.1%	23	14.8%
男性	0	0.0%	1	16.7%	2	11.1%	0	0.0%	1	5.6%	0	0.0%	1	1.6%	5	3.3%
女性	0	0.0%	3	25.0%	6	18.2%	4	15.4%	3	8.1%	4	8.0%	8	5.7%	28	9.2%
男女合計	0	0.0%	3	25.0%	6	18.2%	4	15.4%	3	8.1%	4	8.0%	8	5.7%	28	9.2%
2と回答	0	0.0%	0	0.0%	0	0.0%	0	0.0%	0	0.0%	1	3.7%	0	0.0%	1	0.6%
男性	0	0.0%	0	0.0%	0	0.0%	0	0.0%	0	0.0%	0	0.0%	0	0.0%	0	0.0%
女性	0	0.0%	0	0.0%	0	0.0%	0	0.0%	0	0.0%	1	2.0%	0	0.0%	1	0.3%
男女合計	0	0.0%	0	0.0%	0	0.0%	0	0.0%	0	0.0%	1	2.0%	0	0.0%	1	0.3%
3と回答	0	0.0%	3	50.0%	7	46.7%	4	44.4%	9	47.4%	14	51.9%	49	63.6%	86	55.5%
男性	0	0.0%	1	16.7%	5	27.8%	0	0.0%	1	5.6%	3	13.0%	1	1.6%	11	7.3%
女性	0	0.0%	2	33.3%	2	33.3%	4	44.4%	8	47.4%	11	51.9%	48	63.6%	75	48.0%
男女合計	0	0.0%	4	33.3%	12	36.4%	4	15.4%	10	27.0%	17	34.0%	50	35.7%	97	31.7%
4と回答	2	100.0%	1	16.7%	4	26.7%	1	11.1%	7	36.8%	8	29.6%	19	24.7%	42	27.1%
男性	6	100.0%	4	66.7%	11	61.1%	16	94.1%	16	88.9%	19	82.6%	54	85.7%	126	83.4%
女性	0	0.0%	0	0.0%	0	0.0%	0	0.0%	0	0.0%	0	0.0%	0	0.0%	0	0.0%
男女合計	8	100.0%	5	41.7%	15	45.5%	17	65.4%	23	62.2%	27	54.0%	73	52.1%	168	54.9%
無回答	0	0.0%	0	0.0%	0	0.0%	0	0.0%	1	5.3%	0	0.0%	2	2.6%	3	1.9%
男性	0	0.0%	0	0.0%	0	0.0%	1	5.9%	0	0.0%	1	4.3%	7	11.1%	9	6.0%
女性	0	0.0%	0	0.0%	0	0.0%	0	0.0%	0	0.0%	0	0.0%	0	0.0%	0	0.0%
男女合計	0	0.0%	0	0.0%	0	0.0%	1	3.8%	1	2.7%	1	2.0%	9	6.4%	12	3.9%
全体(人)	2		6		15		9		19		27		77		155	
男性	6		6		18		17		18		23		63		151	
女性	0		0		0		0		0		0		0		0	
男女合計	8		12		33		26		37		50		140		306	

いわき

	20	割合	30	割合	40	割合	50	割合	64	割合	69	割合	70～	割合	全体数	割合
1と回答																
男性	5	21.7%	19	37.3%	18	30.0%	18	26.5%	8	22.9%	11	28.9%	13	9.5%	92	22.3%
女性	3	9.7%	5	11.1%	4	6.6%	9	14.3%	2	4.9%	3	6.1%	2	1.3%	28	6.3%
男女合計	8	14.8%	24	25.0%	22	18.2%	27	20.6%	10	13.2%	14	16.1%	15	5.1%	120	14.0%
2と回答																
男性	1	4.3%	0	0.0%	0	0.0%	2	2.9%	0	0.0%	0	0.0%	1	0.7%	4	1.0%
女性	0	0.0%	1	2.2%	0	0.0%	0	0.0%	1	2.4%	0	0.0%	1	0.6%	3	0.7%
男女合計	1	1.9%	1	1.0%	0	0.0%	2	1.5%	1	1.3%	0	0.0%	2	0.7%	7	0.8%
3と回答																
男性	0	0.0%	8	15.7%	19	31.7%	33	48.5%	16	45.7%	24	63.2%	92	67.2%	192	46.6%
女性	2	6.5%	10	22.2%	14	23.0%	7	11.1%	9	22.0%	4	8.2%	17	10.8%	63	14.1%
男女合計	2	3.7%	18	18.8%	33	27.3%	40	30.5%	25	32.9%	28	32.2%	109	37.1%	255	29.7%
4と回答																
男性	17	73.9%	24	47.1%	22	36.7%	15	22.1%	11	31.4%	3	7.9%	30	21.9%	122	29.6%
女性	26	83.9%	29	64.4%	41	67.2%	47	74.6%	29	70.7%	42	85.7%	121	77.1%	335	74.9%
男女合計	43	79.6%	53	55.2%	63	52.1%	62	47.3%	40	52.6%	45	51.7%	151	51.4%	457	53.2%
無回答																
男性	0	0.0%	0	0.0%	1	1.7%	0	0.0%	0	0.0%	0	0.0%	1	0.7%	2	0.5%
女性	0	0.0%	0	0.0%	2	3.3%	0	0.0%	0	0.0%	0	0.0%	16	10.2%	18	4.0%
男女合計	0	0.0%	0	0.0%	3	2.5%	0	0.0%	0	0.0%	0	0.0%	17	5.8%	20	2.3%
全体(人)																
男性	23		51		60		68		35		38		137		412	
女性	31		45		61		63		41		49		157		447	
男女合計	54		96		121		131		76		87		294		859	

(2) 禁煙の意思 (満20歳以上対象) (調査票 問11付問)

付問 問11で1～2を選んだ方におたずねします。あなたは、たばこをやめたいと思いますか。(あてはまる番号1つに○)

- 1 やめたい 2 本数を減らしたい
3 やめたくない 4 わからない

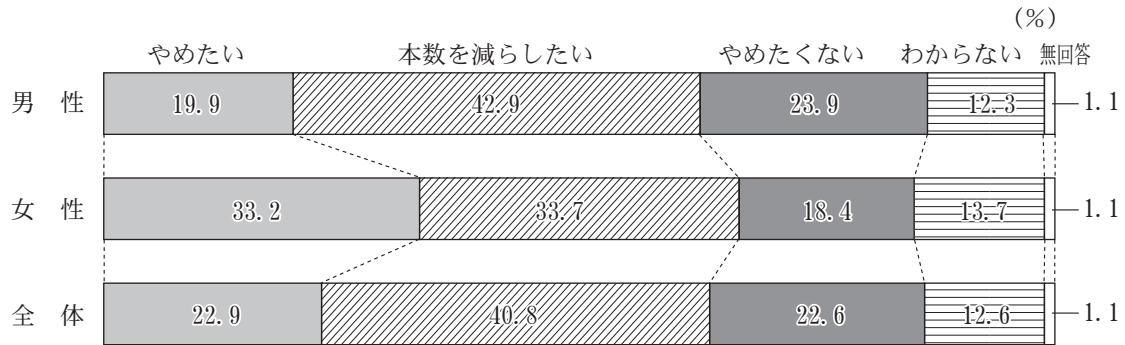

	20	割合	30	割合	40	割合	50	割合	64	割合	69	割合	70	割合	80	割合	90	割合	全体数	割合
1と回答																				
男性	6	13.6%	13	14.1%	27	18.9%	26	17.9%	15	21.7%	15	23.4%	23	28.0%	5	29.4%	1	50.0%	131	19.9%
女性	7	50.0%	8	33.3%	12	29.3%	21	44.7%	6	20.7%	4	23.5%	5	33.3%	0	0.0%	0	0.0%	63	33.2%
男女合計	13	22.4%	21	18.1%	39	21.2%	47	24.5%	21	21.4%	19	23.5%	28	28.9%	5	27.8%	1	25.0%	194	22.9%
2と回答																				
男性	18	40.9%	42	45.7%	51	35.7%	63	43.4%	34	49.3%	32	50.0%	36	43.9%	6	35.3%	0	0.0%	282	42.9%
女性	4	28.6%	7	29.2%	14	34.1%	13	27.7%	12	41.4%	7	41.2%	6	40.0%	0	0.0%	1	50.0%	64	33.7%
男女合計	22	37.9%	49	42.2%	65	35.3%	76	39.6%	46	46.9%	39	48.1%	42	43.3%	6	33.3%	1	25.0%	346	40.8%
3と回答																				
男性	6	13.6%	24	26.1%	44	30.8%	31	21.4%	18	26.1%	17	26.6%	14	17.1%	3	17.6%	0	0.0%	157	23.9%
女性	0	0.0%	3	12.5%	9	22.0%	9	19.1%	9	31.0%	4	23.5%	1	6.7%	0	0.0%	0	0.0%	35	18.4%
男女合計	6	10.3%	27	23.3%	53	28.8%	40	20.8%	27	27.6%	21	25.9%	15	15.5%	3	16.7%	0	0.0%	192	22.6%
4と回答																				
男性	13	29.5%	13	14.1%	20	14.0%	23	15.9%	2	2.9%	0	0.0%	7	8.5%	2	11.8%	1	50.0%	81	12.3%
女性	3	21.4%	6	25.0%	6	14.6%	3	6.4%	2	6.9%	2	11.8%	3	20.0%	0	0.0%	1	50.0%	26	13.7%
男女合計	16	27.6%	19	16.4%	26	14.1%	26	13.5%	4	4.1%	2	2.5%	10	10.3%	2	11.1%	2	50.0%	107	12.6%
無回答																				
男性	1	2.3%	0	0.0%	1	0.7%	2	1.4%	0	0.0%	0	0.0%	2	2.4%	1	5.9%	0	0.0%	7	1.1%
女性	0	0.0%	0	0.0%	0	0.0%	1	2.1%	0	0.0%	0	0.0%	0	0.0%	1	100.0%	0	0.0%	2	1.1%
男女合計	1	1.7%	0	0.0%	1	0.5%	3	1.6%	0	0.0%	0	0.0%	2	2.1%	2	11.1%	0	0.0%	9	1.1%
全体(人)																				
男性	44		92		143		145		69		64		82		17		2		658	
女性	14		24		41		47		29		17		15		1		2		190	
男女合計	58		116		184		192		98		81		97		18		4		848	

県 北

	20	割合	30	割合	40	割合	50	割合	64	割合	69	割合	70～	割合	全体数	割合
1と回答																
男性	2	14.3%	2	6.1%	9	22.5%	2	5.1%	4	23.5%	0	0.0%	5	17.2%	24	13.3%
女性	2	50.0%	0	0.0%	4	30.8%	5	45.5%	3	33.3%	1	16.7%	2	33.3%	17	30.9%
男女合計	4	22.2%	2	5.1%	13	24.5%	7	14.0%	7	26.9%	1	7.1%	7	20.0%	41	17.4%
2と回答																
男性	6	42.9%	17	51.5%	17	42.5%	18	46.2%	9	52.9%	6	75.0%	13	44.8%	86	47.8%
女性	0	0.0%	1	16.7%	4	30.8%	2	18.2%	3	33.3%	2	33.3%	3	50.0%	15	27.3%
男女合計	6	33.3%	18	46.2%	21	39.6%	20	40.0%	12	46.2%	8	57.1%	16	45.7%	101	43.0%
3と回答																
男性	2	14.3%	8	24.2%	6	15.0%	9	23.1%	4	23.5%	2	25.0%	7	24.1%	38	21.1%
女性	0	0.0%	1	16.7%	4	30.8%	3	27.3%	3	33.3%	1	16.7%	0	0.0%	12	21.8%
男女合計	2	11.1%	9	23.1%	10	18.9%	12	24.0%	7	26.9%	3	21.4%	7	20.0%	50	21.3%
4と回答																
男性	4	28.6%	6	18.2%	8	20.0%	9	23.1%	0	0.0%	0	0.0%	3	10.3%	30	16.7%
女性	2	50.0%	4	66.7%	1	7.7%	1	9.1%	0	0.0%	2	33.3%	1	16.7%	11	20.0%
男女合計	6	33.3%	10	25.6%	9	17.0%	10	20.0%	0	0.0%	2	14.3%	4	11.4%	41	17.4%
無回答																
男性	0	0.0%	0	0.0%	0	0.0%	1	2.6%	0	0.0%	0	0.0%	1	3.4%	2	1.1%
女性	0	0.0%	0	0.0%	0	0.0%	0	0.0%	0	0.0%	0	0.0%	0	0.0%	0	0.0%
男女合計	0	0.0%	0	0.0%	0	0.0%	1	2.0%	0	0.0%	0	0.0%	1	2.9%	2	0.9%
全体(人)																
男性	14		33		40		39		17		8		29		180	
女性	4		6		13		11		9		6		6		55	
男女合計	18		39		53		50		26		14		35		235	

県 中

	20	割合	30	割合	40	割合	50	割合	64	割合	69	割合	70～	割合	全体数	割合
1と回答																
男性	0	0.0%	5	33.3%	7	17.9%	12	23.5%	4	18.2%	7	35.0%	9	30.0%	44	23.8%
女性	1	50.0%	3	75.0%	5	31.3%	6	42.9%	2	18.2%	0	0.0%	1	33.3%	18	36.0%
男女合計	1	10.0%	8	42.1%	12	21.8%	18	27.7%	6	18.2%	7	35.0%	10	30.3%	62	26.4%
2と回答																
男性	5	62.5%	4	26.7%	14	35.9%	26	51.0%	12	54.5%	9	45.0%	11	36.7%	81	43.8%
女性	0	0.0%	1	25.0%	4	25.0%	4	28.6%	6	54.5%	0	0.0%	0	0.0%	15	30.0%
男女合計	5	50.0%	5	26.3%	18	32.7%	30	46.2%	18	54.5%	9	45.0%	11	33.3%	96	40.9%
3と回答																
男性	2	25.0%	4	26.7%	14	35.9%	6	11.8%	6	27.3%	4	20.0%	6	20.0%	42	22.7%
女性	0	0.0%	0	0.0%	4	25.0%	2	14.3%	2	18.2%	0	0.0%	0	0.0%	8	16.0%
男女合計	2	20.0%	4	21.1%	18	32.7%	8	12.3%	8	24.2%	4	20.0%	6	18.2%	50	21.3%
4と回答																
男性	1	12.5%	2	13.3%	4	10.3%	6	11.8%	0	0.0%	0	0.0%	3	10.0%	16	8.6%
女性	1	50.0%	0	0.0%	3	18.8%	1	7.1%	1	9.1%	0	0.0%	1	33.3%	7	14.0%
男女合計	2	20.0%	2	10.5%	7	12.7%	7	10.8%	1	3.0%	0	0.0%	4	12.1%	23	9.8%
無回答																
男性	0	0.0%	0	0.0%	0	0.0%	1	2.0%	0	0.0%	0	0.0%	1	3.3%	2	1.1%
女性	0	0.0%	0	0.0%	0	0.0%	1	7.1%	0	0.0%	0	0.0%	1	33.3%	2	4.0%
男女合計	0	0.0%	0	0.0%	0	0.0%	2	3.1%	0	0.0%	0	0.0%	2	6.1%	4	1.7%
全体(人)																
男性	8		15		39		51		22		20		30		185	
女性	2		4		16		14		11		0		3		50	
男女合計	10		19		55		65		33		20		33		235	

県 南

	20	割合	30	割合	40	割合	50	割合	64	割合	69	割合	70～	割合	全体数	割合
1と回答																
男性	1	11.1%	2	15.4%	4	23.5%	4	30.8%	1	16.7%	1	25.0%	2	20.0%	15	20.8%
女性	0	0.0%	0	0.0%	1	100.0%	3	75.0%	0	0.0%	0	0.0%	0	0.0%	4	28.6%
男女合計	1	11.1%	2	12.5%	5	27.8%	7	41.2%	1	14.3%	1	20.0%	2	14.3%	19	22.1%
2と回答																
男性	3	33.3%	7	53.8%	5	29.4%	4	30.8%	2	33.3%	2	50.0%	5	50.0%	28	38.9%
女性	0	0.0%	1	33.3%	0	0.0%	0	0.0%	1	100.0%	0	0.0%	2	50.0%	4	28.6%
男女合計	3	33.3%	8	50.0%	5	27.8%	4	23.5%	3	42.9%	2	40.0%	7	50.0%	32	37.2%
3と回答																
男性	1	11.1%	2	15.4%	7	41.2%	4	30.8%	3	50.0%	1	25.0%	1	10.0%	19	26.4%
女性	0	0.0%	1	33.3%	0	0.0%	1	25.0%	0	0.0%	1	100.0%	0	0.0%	3	21.4%
男女合計	1	11.1%	3	18.8%	7	38.9%	5	29.4%	3	42.9%	2	40.0%	1	7.1%	22	25.6%
4と回答																
男性	4	44.4%	2	15.4%	1	5.9%	1	7.7%	0	0.0%	0	0.0%	2	20.0%	10	13.9%
女性	0	0.0%	1	33.3%	0	0.0%	0	0.0%	0	0.0%	0	0.0%	2	50.0%	3	21.4%
男女合計	4	44.4%	3	18.8%	1	5.6%	1	5.9%	0	0.0%	0	0.0%	4	28.6%	13	15.1%
無回答																
男性	0	0.0%	0	0.0%	0	0.0%	0	0.0%	0	0.0%	0	0.0%	0	0.0%	0	0.0%
女性	0	0.0%	0	0.0%	0	0.0%	0	0.0%	0	0.0%	0	0.0%	0	0.0%	0	0.0%
男女合計	0	0.0%	0	0.0%	0	0.0%	0	0.0%	0	0.0%	0	0.0%	0	0.0%	0	0.0%
全体(人)																
男性	9		13		17		13		6		4		10		72	
女性	0		3		1		4		1		1		4		14	
男女合計	9		16		18		17		7		5		14		86	

会 津

	20	割合	30	割合	40	割合	50	割合	64	割合	69	割合	70～	割合	全体数	割合
1と回答																
男性	2	28.6%	0	0.0%	2	8.7%	1	7.1%	3	21.4%	2	16.7%	6	75.0%	16	18.6%
女性	3	75.0%	1	33.3%	1	20.0%	4	57.1%	0	0.0%	2	40.0%	0	0.0%	11	37.9%
男女合計	5	45.5%	1	9.1%	3	10.7%	5	23.8%	3	16.7%	4	23.5%	6	66.7%	27	23.5%
2と回答																
男性	1	14.3%	2	25.0%	11	47.8%	7	50.0%	4	28.6%	8	66.7%	0	0.0%	33	38.4%
女性	1	25.0%	1	33.3%	2	40.0%	1	14.3%	1	25.0%	2	40.0%	1	100.0%	9	31.0%
男女合計	2	18.2%	3	27.3%	13	46.4%	8	38.1%	5	27.8%	10	58.8%	1	11.1%	42	36.5%
3と回答																
男性	1	14.3%	5	62.5%	7	30.4%	4	28.6%	5	35.7%	2	16.7%	1	12.5%	25	29.1%
女性	0	0.0%	1	33.3%	1	20.0%	2	28.6%	2	50.0%	1	20.0%	0	0.0%	7	24.1%
男女合計	1	9.1%	6	54.5%	8	28.6%	6	28.6%	7	38.9%	3	17.6%	1	11.1%	32	27.8%
4と回答																
男性	2	28.6%	1	12.5%	3	13.0%	2	14.3%	2	14.3%	0	0.0%	1	12.5%	11	12.8%
女性	0	0.0%	0	0.0%	1	20.0%	0	0.0%	1	25.0%	0	0.0%	0	0.0%	2	6.9%
男女合計	2	18.2%	1	9.1%	4	14.3%	2	9.5%	3	16.7%	0	0.0%	1	11.1%	13	11.3%
無回答																
男性	1	14.3%	0	0.0%	0	0.0%	0	0.0%	0	0.0%	0	0.0%	0	0.0%	1	1.2%
女性	0	0.0%	0	0.0%	0	0.0%	0	0.0%	0	0.0%	0	0.0%	0	0.0%	0	0.0%
男女合計	1	9.1%	0	0.0%	0	0.0%	0	0.0%	0	0.0%	0	0.0%	0	0.0%	1	0.9%
全体(人)																
男性	7		8		23		14		14		12		8		86	
女性	4		3		5		7		4		5		1		29	
男女合計	11		11		28		21		18		17		9		115	

南 会 津

	20	割合	30	割合	40	割合	50	割合	64	割合	69	割合	70～	割合	全体数	割合
1と回答																
男性	0	0.0%	1	50.0%	1	50.0%	1	25.0%	0	0.0%	0	0.0%	0	0.0%	3	20.0%
女性	0	0.0%	1	100.0%	0	0.0%	0	0.0%	0	0.0%	1	50.0%	0	0.0%	2	33.3%
男女合計	0	0.0%	2	66.7%	1	50.0%	1	16.7%	0	0.0%	1	16.7%	0	0.0%	5	23.8%
2と回答																
男性	0	0.0%	1	50.0%	0	0.0%	1	25.0%	0	0.0%	0	0.0%	2	66.7%	4	26.7%
女性	1	100.0%	0	0.0%	0	0.0%	1	50.0%	0	0.0%	1	50.0%	0	0.0%	3	50.0%
男女合計	1	100.0%	1	33.3%	0	0.0%	2	33.3%	0	0.0%	1	16.7%	2	66.7%	7	33.3%
3と回答																
男性	0	0.0%	0	0.0%	1	50.0%	1	25.0%	0	0.0%	4	100.0%	0	0.0%	6	40.0%
女性	0	0.0%	0	0.0%	0	0.0%	0	0.0%	0	0.0%	0	0.0%	0	0.0%	0	0.0%
男女合計	0	0.0%	0	0.0%	1	50.0%	1	16.7%	0	0.0%	4	66.7%	0	0.0%	6	28.6%
4と回答																
男性	0	0.0%	0	0.0%	0	0.0%	1	25.0%	0	0.0%	0	0.0%	1	33.3%	2	13.3%
女性	0	0.0%	0	0.0%	0	0.0%	1	50.0%	0	0.0%	0	0.0%	0	0.0%	1	16.7%
男女合計	0	0.0%	0	0.0%	0	0.0%	2	33.3%	0	0.0%	0	0.0%	1	33.3%	3	14.3%
無回答																
男性	0	0.0%	0	0.0%	0	0.0%	0	0.0%	0	0.0%	0	0.0%	0	0.0%	0	0.0%
女性	0	0.0%	0	0.0%	0	0.0%	0	0.0%	0	0.0%	0	0.0%	0	0.0%	0	0.0%
男女合計	0	0.0%	0	0.0%	0	0.0%	0	0.0%	0	0.0%	0	0.0%	0	0.0%	0	0.0%
全体(人)																
男性	0		2		2		4		0		4		3		15	
女性	1		1		0		2		0		2		0		6	
男女合計	1		3		2		6		0		6		3		21	

相 双

	20	割合	30	割合	40	割合	50	割合	64	割合	69	割合	70～	割合	全体数	割合
1と回答																
男性	0	0.0%	0	0.0%	1	25.0%	2	50.0%	1	50.0%	3	60.0%	4	57.1%	11	45.8%
女性	0	0.0%	1	100.0%	0	0.0%	0	0.0%	0	0.0%	0	0.0%	1	100.0%	2	40.0%
男女合計	0	0.0%	1	33.3%	1	16.7%	2	50.0%	1	33.3%	3	60.0%	5	62.5%	13	44.8%
2と回答																
男性	0	0.0%	1	50.0%	1	25.0%	0	0.0%	1	50.0%	1	20.0%	3	42.9%	7	29.2%
女性	0	0.0%	0	0.0%	1	50.0%	0	0.0%	0	0.0%	0	0.0%	0	0.0%	1	20.0%
男女合計	0	0.0%	1	33.3%	2	33.3%	0	0.0%	1	33.3%	1	20.0%	3	37.5%	8	27.6%
3と回答																
男性	0	0.0%	0	0.0%	2	50.0%	2	50.0%	0	0.0%	1	20.0%	0	0.0%	5	20.8%
女性	0	0.0%	0	0.0%	0	0.0%	0	0.0%	1	100.0%	0	0.0%	0	0.0%	1	20.0%
男女合計	0	0.0%	0	0.0%	2	33.3%	2	50.0%	1	33.3%	1	20.0%	0	0.0%	6	20.7%
4と回答																
男性	0	0.0%	1	50.0%	0	0.0%	0	0.0%	0	0.0%	0	0.0%	0	0.0%	1	4.2%
女性	0	0.0%	0	0.0%	1	50.0%	0	0.0%	0	0.0%	0	0.0%	0	0.0%	1	20.0%
男女合計	0	0.0%	1	33.3%	1	16.7%	0	0.0%	0	0.0%	0	0.0%	0	0.0%	2	6.9%
無回答																
男性	0	0.0%	0	0.0%	0	0.0%	0	0.0%	0	0.0%	0	0.0%	0	0.0%	0	0.0%
女性	0	0.0%	0	0.0%	0	0.0%	0	0.0%	0	0.0%	0	0.0%	0	0.0%	0	0.0%
男女合計	0	0.0%	0	0.0%	0	0.0%	0	0.0%	0	0.0%	0	0.0%	0	0.0%	0	0.0%
全体(人)																
男性	0		2		4		4		2		5		7		24	
女性	0		1		2		0		1		0		1		5	
男女合計	0		3		6		4		3		5		8		29	

いわき

	20	割合	30	割合	40	割合	50	割合	64	割合	69	割合	70～	割合	全体数	割合
1と回答																
男性	1	16.7%	3	15.8%	3	16.7%	4	20.0%	2	25.0%	2	18.2%	3	21.4%	18	18.8%
女性	1	33.3%	2	33.3%	1	25.0%	3	33.3%	1	33.3%	0	0.0%	1	33.3%	9	29.0%
男女合計	2	22.2%	5	20.0%	4	18.2%	7	24.1%	3	27.3%	2	14.3%	4	23.5%	27	21.3%
2と回答																
男性	3	50.0%	10	52.6%	3	16.7%	7	35.0%	6	75.0%	6	54.5%	8	57.1%	43	44.8%
女性	2	66.7%	3	50.0%	3	75.0%	5	55.6%	1	33.3%	2	66.7%	1	33.3%	17	54.8%
男女合計	5	55.6%	13	52.0%	6	27.3%	12	41.4%	7	63.6%	8	57.1%	9	52.9%	60	47.2%
3と回答																
男性	0	0.0%	5	26.3%	7	38.9%	5	25.0%	0	0.0%	3	27.3%	2	14.3%	22	22.9%
女性	0	0.0%	0	0.0%	0	0.0%	1	11.1%	1	33.3%	1	33.3%	1	33.3%	4	12.9%
男女合計	0	0.0%	5	20.0%	7	31.8%	6	20.7%	1	9.1%	4	28.6%	3	17.6%	26	20.5%
4と回答																
男性	2	33.3%	1	5.3%	4	22.2%	4	20.0%	0	0.0%	0	0.0%	0	0.0%	11	11.5%
女性	0	0.0%	1	16.7%	0	0.0%	0	0.0%	0	0.0%	0	0.0%	0	0.0%	1	3.2%
男女合計	2	22.2%	2	8.0%	4	18.2%	4	13.8%	0	0.0%	0	0.0%	0	0.0%	12	9.4%
無回答																
男性	0	0.0%	0	0.0%	1	5.6%	0	0.0%	0	0.0%	0	0.0%	1	7.1%	2	2.1%
女性	0	0.0%	0	0.0%	0	0.0%	0	0.0%	0	0.0%	0	0.0%	0	0.0%	0	0.0%
男女合計	0	0.0%	0	0.0%	1	4.5%	0	0.0%	0	0.0%	0	0.0%	1	5.9%	2	1.6%
全体(人)																
男性	6		19		18		20		8		11		14		96	
女性	3		6		4		9		3		3		3		31	
男女合計	9		25		22		29		11		14		17		127	

(3) 家族(世帯)の喫煙状況(調査票 問12)

問12 あなたの家族で、あなたを含めて、たばこを吸っている方はいますか。

1 いる 2 いない



	県北	割合	県中	割合	県南	割合	会津	割合	南会津	割合	相双	割合	いわき	割合	全体数	割合
1 いる	235	31.4%	226	34.3%	84	34.0%	115	32.6%	22	46.8%	44	25.3%	129	28.5%	855	31.9%
2 いない	508	67.9%	428	65.0%	159	64.4%	233	66.0%	24	51.1%	126	72.4%	319	70.4%	1,797	67.1%
不明	5	0.7%	4	0.6%	4	1.6%	5	1.4%	1	2.1%	4	2.3%	5	1.1%	28	1.0%
回答世帯数	748		658		247		353		47		174		453		2,680	

13 受動喫煙の状況（調査票 問13）

問13 あなたは、この1か月間に、自分以外の人が吸っていたたばこの煙を吸う機会（受動喫煙）がありましたか。（各項目につき、○は1つ）

- 1 ほぼ毎日 2 週に数回程度 3 週に1回程度
4 月に1回程度 5 全くなかった 6 いかなかった

○家 庭

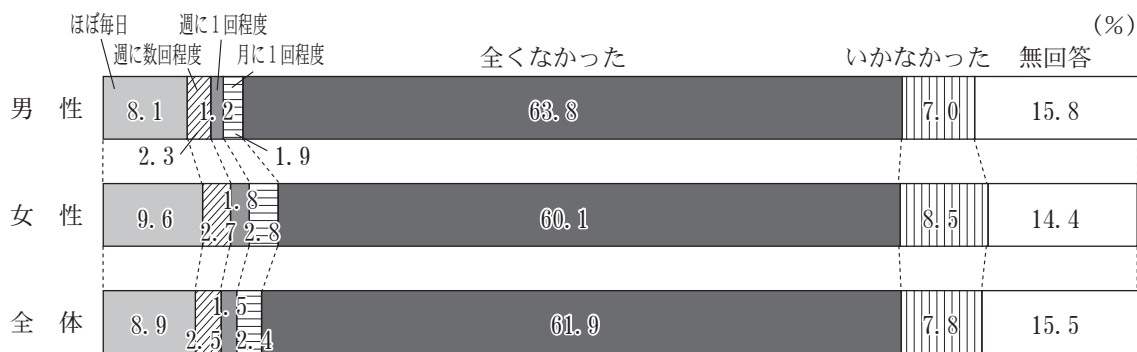

○職 場

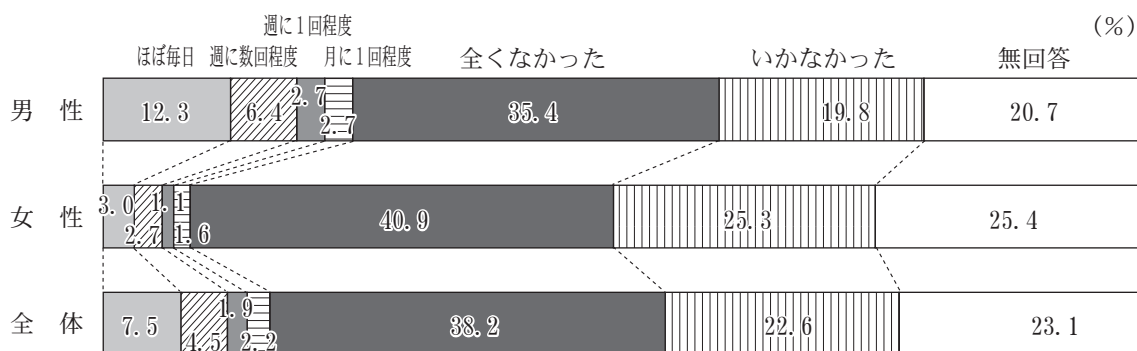

○学 校

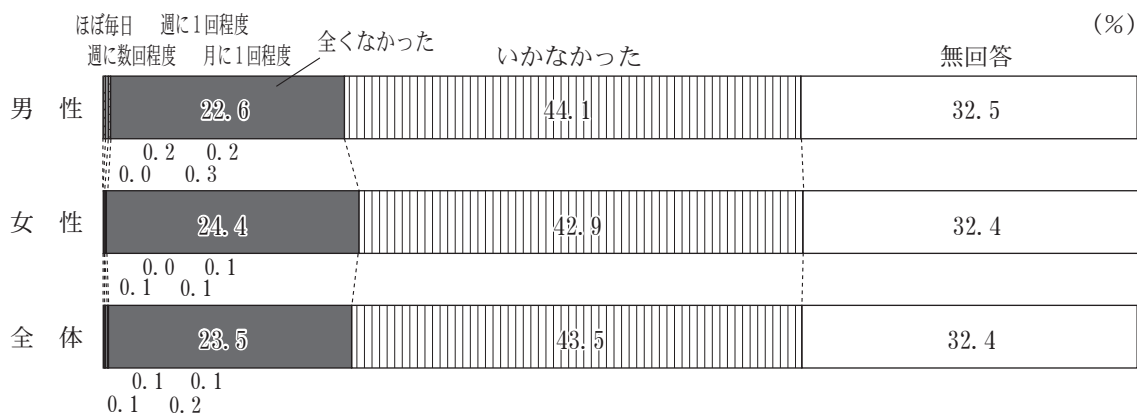

○飲食店

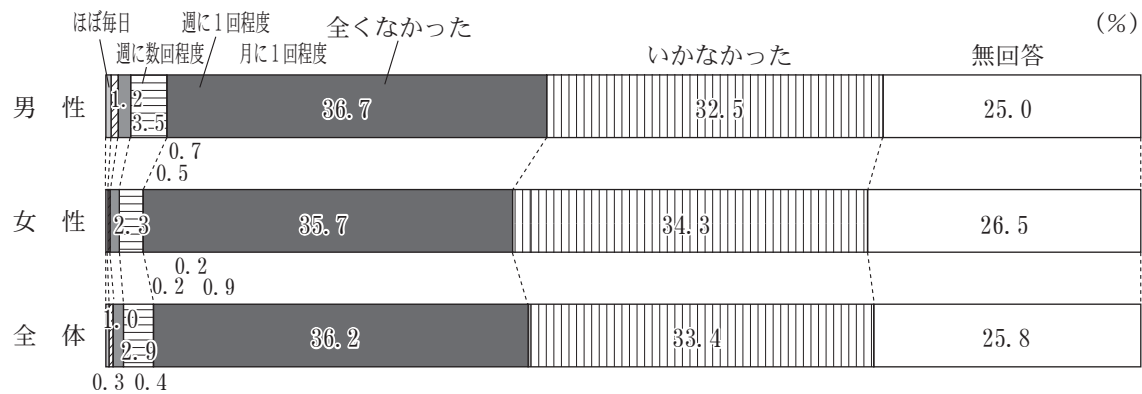

○遊技場

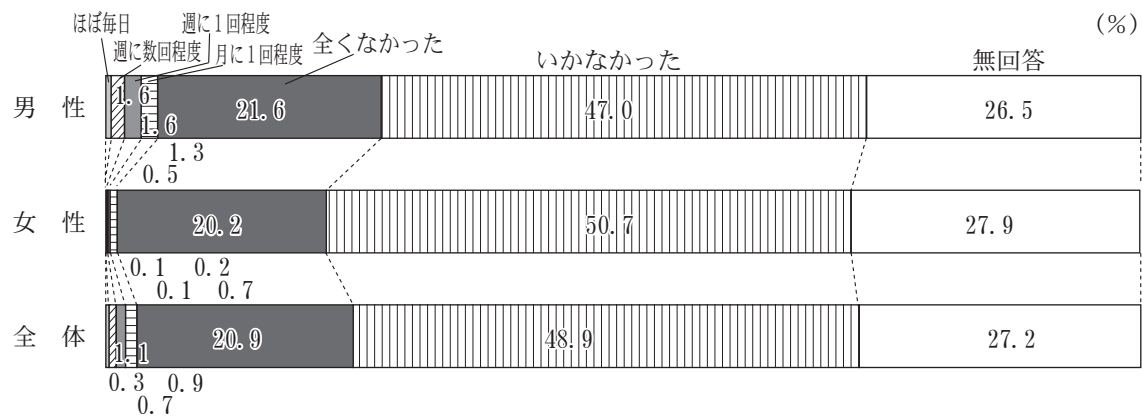

○行政機関

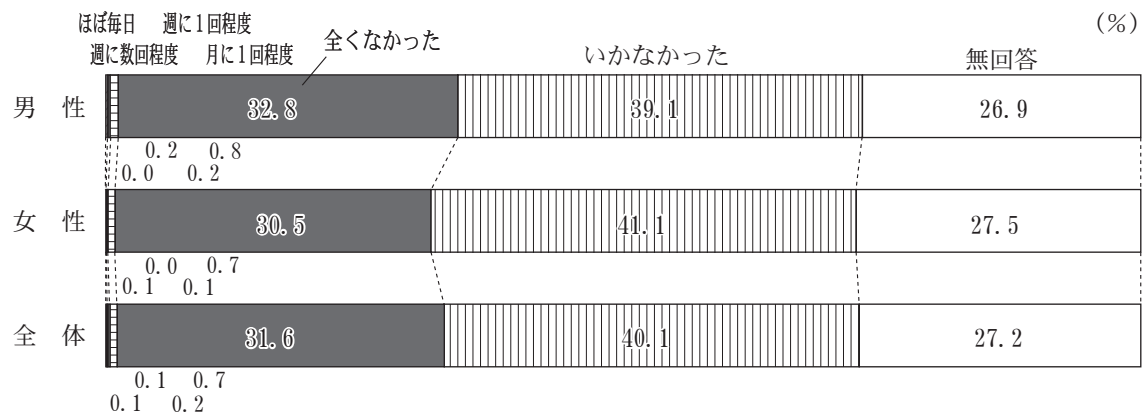

○医療機関

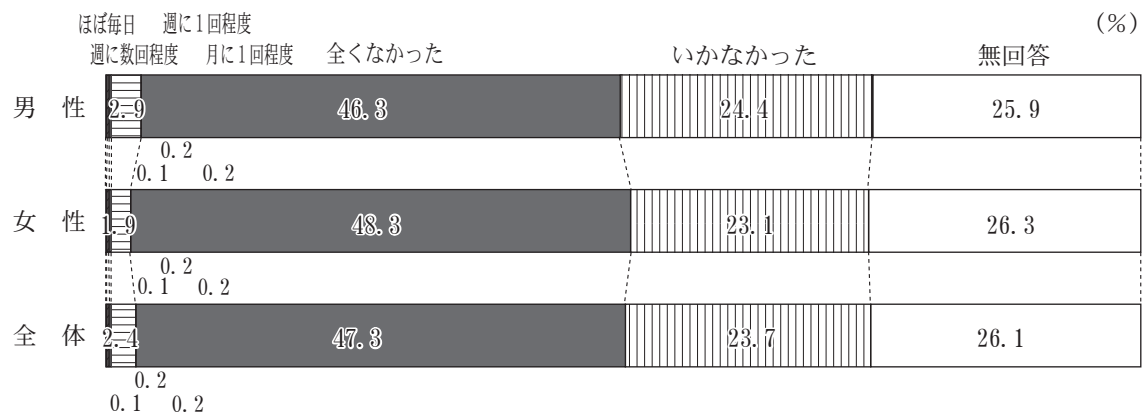

○公共交通機関

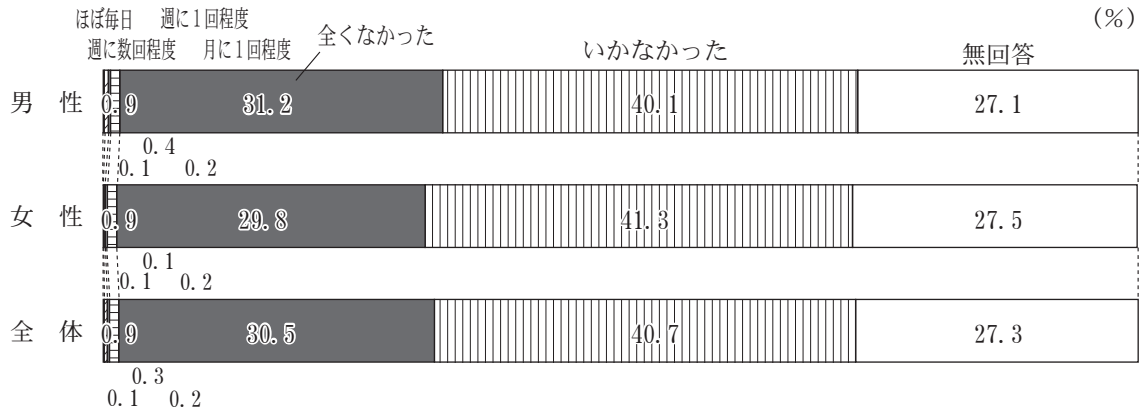

○路上

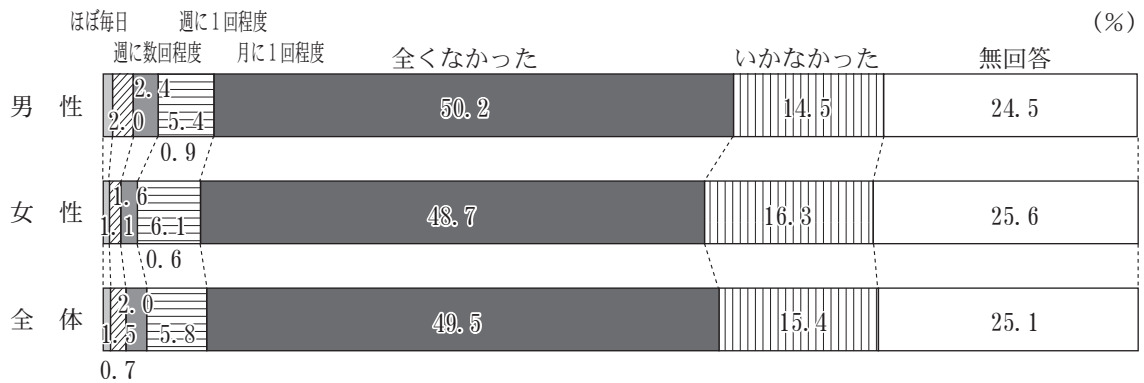

○子供が利用する屋外の空間

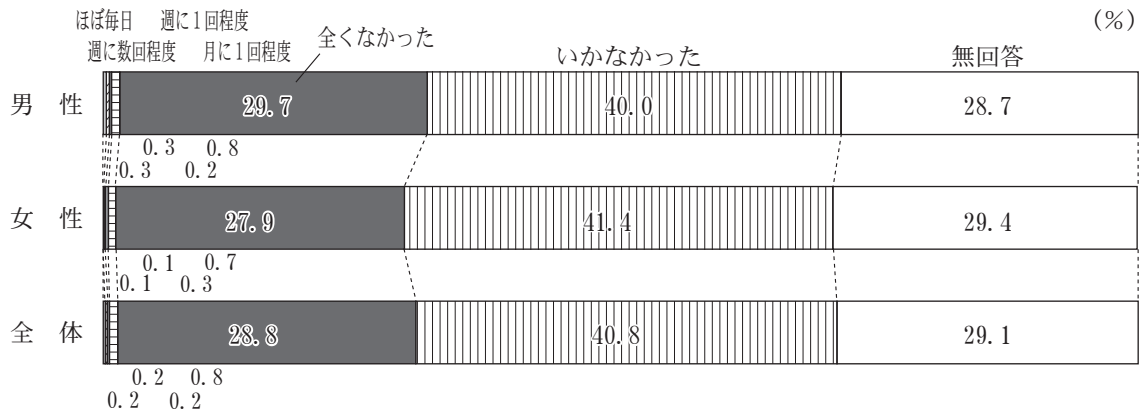

○健康増進施設

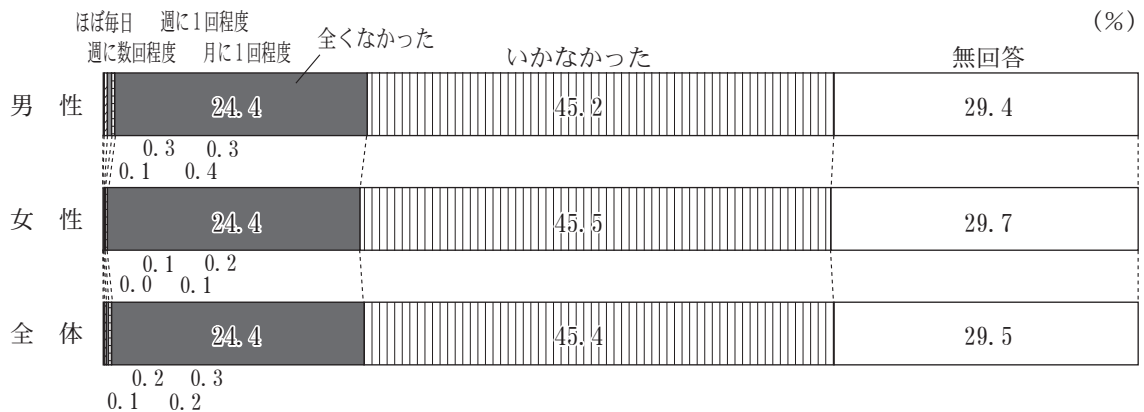

○家庭

	10	割合	20	割合	30	割合	40	割合	50	割合	64	割合	69	割合	70	割合	80	割合	90	割合	全体数	割合		
1と回答	13	10.9%	27	16.3%	17	6.8%	43	11.5%	38	9.7%	27	10.3%	13	4.6%	25	5.0%	9	3.3%	2	5.3%	214	8.1%		
男性	9	7.3%	23	12.8%	30	12.2%	35	10.3%	57	12.9%	35	13.5%	25	8.2%	37	7.3%	12	3.7%	8	9.6%	271	9.6%		
女性	4	3.6%	4	2.0%	17	6.9%	10	2.9%	8	1.8%	7	2.7%	7	2.3%	9	1.8%	3	0.9%	1	1.2%	43	1.5%		
男女合計	22	9.1%	50	14.5%	47	9.5%	78	10.9%	95	11.4%	62	11.9%	38	6.4%	62	6.2%	21	3.5%	10	8.3%	485	8.9%		
2と回答	7	5.9%	7	4.2%	12	4.8%	9	2.4%	3	0.8%	5	1.9%	4	1.4%	8	1.6%	4	1.5%	1	2.6%	60	2.3%		
男性	8	6.5%	6	3.4%	17	6.9%	10	2.9%	8	1.8%	7	2.7%	7	2.3%	9	1.8%	3	0.9%	1	1.2%	76	2.7%		
女性	1	0.8%	1	0.4%	12	4.8%	9	2.4%	3	0.8%	5	1.9%	4	1.4%	8	1.6%	4	1.5%	1	2.6%	16	0.5%		
男女合計	15	6.2%	13	3.8%	29	5.8%	19	2.7%	11	1.3%	12	2.3%	11	1.9%	17	1.7%	7	1.2%	2	1.7%	136	2.5%		
3と回答	3	2.5%	3	1.8%	2	0.8%	6	1.6%	4	1.0%	2	0.8%	2	0.7%	6	1.2%	3	1.1%	2	5.3%	33	1.2%		
男性	2	1.6%	4	2.2%	7	2.8%	8	2.4%	10	2.3%	6	2.3%	3	1.0%	8	1.6%	2	0.6%	0	0.0%	50	1.8%		
女性	1	0.8%	1	0.4%	2	0.8%	6	1.6%	4	1.0%	2	0.8%	2	0.7%	6	1.2%	3	1.1%	2	5.3%	11	0.4%		
男女合計	5	2.1%	7	2.0%	9	1.8%	14	2.0%	14	1.7%	8	1.5%	5	0.8%	14	1.4%	5	0.8%	2	1.7%	83	1.5%		
4と回答	5	4.2%	2	1.2%	6	2.4%	3	0.8%	14	3.6%	3	1.1%	5	1.8%	10	2.0%	2	0.7%	0	0.0%	50	1.9%		
男性	7	5.6%	6	3.4%	9	3.7%	13	3.8%	17	3.9%	3	1.2%	5	1.6%	14	2.8%	5	1.5%	0	0.0%	79	2.8%		
女性	2	1.6%	2	1.0%	3	1.2%	2	0.6%	10	2.3%	6	2.3%	3	1.0%	8	1.6%	2	0.6%	0	0.0%	19	0.7%		
男女合計	12	4.9%	8	2.3%	15	3.0%	16	2.2%	31	3.7%	6	1.1%	10	1.7%	24	2.4%	7	1.2%	0	0.0%	129	2.4%		
5と回答	70	58.8%	93	56.0%	166	66.1%	257	68.7%	257	65.6%	184	70.0%	191	67.0%	316	63.6%	141	52.0%	19	50.0%	1694	63.8%		
男性	76	61.3%	105	58.7%	138	56.1%	229	67.4%	283	64.2%	164	63.1%	205	67.0%	278	54.6%	173	53.6%	39	47.0%	1690	60.1%		
女性	14	11.3%	21	11.7%	30	12.2%	23	6.8%	23	5.2%	16	6.2%	16	5.2%	46	9.0%	36	11.1%	15	18.1%	184	6.9%		
男女合計	146	60.1%	198	57.4%	304	61.2%	486	68.1%	540	64.8%	348	66.5%	396	67.0%	594	59.0%	314	52.9%	58	47.9%	3384	61.9%		
6と回答	14	11.8%	24	14.5%	21	8.4%	18	4.8%	19	4.8%	11	4.2%	14	4.9%	33	6.6%	27	10.0%	5	13.2%	186	7.0%		
男性	14	11.3%	21	11.7%	30	12.2%	23	6.8%	23	5.2%	16	6.2%	16	5.2%	46	9.0%	36	11.1%	15	18.1%	240	8.5%		
女性	2	1.6%	3	1.5%	11	4.4%	11	4.4%	11	4.4%	11	4.4%	11	4.4%	11	4.4%	11	4.4%	11	4.4%	11	4.4%	46	1.7%
男女合計	28	11.5%	45	13.0%	51	10.3%	41	5.7%	42	5.0%	27	5.2%	30	5.1%	79	7.9%	63	10.6%	20	16.5%	426	7.8%		
無回答	7	5.9%	10	6.0%	27	10.8%	38	10.2%	57	14.5%	31	11.8%	56	19.6%	99	19.9%	85	31.4%	9	23.7%	419	15.8%		
男性	8	6.5%	14	7.8%	15	6.1%	22	6.5%	43	9.8%	29	11.2%	45	14.7%	117	23.0%	92	28.5%	20	24.1%	405	14.4%		
女性	15	6.2%	24	7.0%	42	8.5%	60	8.4%	100	12.0%	60	11.5%	101	17.1%	216	21.5%	177	29.8%	29	24.0%	824	15.1%		
男女合計	119		166		251		374		392		263		285		497		271		38		2656			
全体(人)	124		179		246		340		441		260		306		509		323		83		2811			
男性	243		345		497		714		833		523		591		1006		594		121		5467			
女性																								

○職場

	10	割合	20	割合	30	割合	40	割合	50	割合	64	割合	69	割合	70	割合	80	割合	90	割合	全体数	割合
1と回答	1	0.8%	30	18.1%	62	24.7%	82	21.9%	78	19.9%	41	15.6%	23	8.1%	10	2.0%	0	0.0%	0	0.0%	327	12.3%
男性	0	0.0%	11	6.1%	14	5.7%	12	3.5%	29	6.6%	12	4.6%	2	0.7%	3	0.6%	0	0.0%	0	0.0%	83	3.0%
女性	1	0.4%	41	11.9%	76	15.3%	94	13.2%	107	12.8%	53	10.1%	25	4.2%	13	1.3%	0	0.0%	0	0.0%	410	7.5%
男女合計	1	0.4%	41	11.9%	76	15.3%	94	13.2%	107	12.8%	53	10.1%	25	4.2%	13	1.3%	0	0.0%	0	0.0%	410	7.5%
2と回答	1	0.8%	16	9.6%	32	12.7%	39	10.4%	44	11.2%	17	6.5%	10	3.5%	10	2.0%	0	0.0%	0	0.0%	169	6.4%
男性	0	0.0%	14	7.8%	10	4.1%	16	4.7%	13	2.9%	10	3.8%	9	2.9%	4	0.8%	0	0.0%	0	0.0%	76	2.7%
女性	1	0.4%	30	8.7%	42	8.5%	55	7.7%	57	6.8%	27	5.2%	19	3.2%	14	1.4%	0	0.0%	0	0.0%	245	4.5%
男女合計	1	0.4%	30	8.7%	42	8.5%	55	7.7%	57	6.8%	27	5.2%	19	3.2%	14	1.4%	0	0.0%	0	0.0%	245	4.5%
3と回答	1	0.8%	5	3.0%	11	4.4%	21	5.6%	18	4.6%	6	2.3%	6	2.1%	5	1.0%	0	0.0%	0	0.0%	73	2.7%
男性	0	0.0%	5	2.8%	3	1.2%	7	2.1%	9	2.0%	3	1.2%	2	0.7%	3	0.6%	0	0.0%	0	0.0%	32	1.1%
女性	1	0.4%	10	2.9%	14	2.8%	28	3.9%	27	3.2%	9	1.7%	8	1.4%	8	0.8%	0	0.0%	0	0.0%	105	1.9%
男女合計	1	0.4%	10	2.9%	14	2.8%	28	3.9%	27	3.2%	9	1.7%	8	1.4%	8	0.8%	0	0.0%	0	0.0%	105	1.9%
4と回答	0	0.0%	6	3.6%	8	3.2%	19	5.1%	18	4.6%	9	3.4%	7	2.5%	5	1.0%	1	0.4%	0	0.0%	73	2.7%
男性	2	1.6%	9	5.0%	9	3.7%	9	2.6%	9	2.0%	4	1.5%	1	0.3%	2	0.4%	0	0.0%	0	0.0%	45	1.6%
女性	2	0.8%	15	4.3%	17	3.4%	28	3.9%	27	3.2%	13	2.5%	8	1.4%	7	0.7%	1	0.2%	0	0.0%	118	2.2%
男女合計	2	0.8%	15	4.3%	17	3.4%	28	3.9%	27	3.2%	13	2.5%	8	1.4%	7	0.7%	1	0.2%	0	0.0%	118	2.2%
5と回答	37	31.1%	65	39.2%	95	37.8%	144	38.5%	169	43.1%	128	48.7%	98	34.4%	157	31.6%	41	15.1%	5	13.2%	939	35.4%
男性	53	42.7%	83	46.4%	126	51.2%	215	63.2%	258	58.5%	116	44.6%	112	36.6%	104	20.4%	68	21.1%	15	18.1%	1150	40.9%
女性	90	37.0%	148	42.9%	221	44.5%	359	50.3%	427	51.3%	244	46.7%	210	35.5%	261	25.9%	109	18.4%	20	16.5%	2089	38.2%
男女合計	60	50.4%	29	17.5%	25	10.0%	33	8.8%	33	8.4%	41	15.6%	83	29.1%	134	27.0%	74	27.3%	13	34.2%	525	19.8%
男性	52	41.9%	33	18.4%	67	27.2%	53	15.6%	73	16.6%	65	25.0%	85	27.8%	153	30.1%	97	30.0%	32	38.6%	710	25.3%
女性	112	46.1%	62	18.0%	92	18.5%	86	12.0%	106	12.7%	106	20.3%	168	28.4%	287	28.5%	171	28.8%	45	37.2%	1235	22.6%
無回答	19	16.0%	15	9.0%	18	7.2%	36	9.6%	32	8.2%	21	8.0%	58	20.4%	176	35.4%	155	57.2%	20	52.6%	550	20.7%
男性	17	13.7%	24	13.4%	17	6.9%	28	8.2%	50	11.3%	50	19.2%	95	31.0%	240	47.2%	158	48.9%	36	43.4%	715	25.4%
女性	36	14.8%	39	11.3%	35	7.0%	64	9.0%	82	9.8%	71	13.6%	153	25.9%	416	41.4%	313	52.7%	56	46.3%	1265	23.1%
男女合計	119		166		251		374		392		263		285		497		271		38		2656	
全体(人)	124		179		246		340		441		260		306		509		323		83		2811	
男性	243		345		497		714		833		523		591		1006		594		121		5467	
女性																						

○学校

	10	割合	20	割合	30	割合	40	割合	50	割合	64	割合	69	割合	70	割合	80	割合	90	割合	全体数	割合
1と回答	0	0.0%	1	0.6%	0	0.0%	0	0.0%	0	0.0%	0	0.0%	0	0.0%	0	0.0%	0	0.0%	0	0.0%	1	0.0%
男性	1	0.8%	0	0.0%	0	0.0%	0	0.0%	1	0.2%	0	0.0%	0	0.0%	0	0.0%	0	0.0%	0	0.0%	2	0.1%
女性	1	0.4%	1	0.3%																		

○飲食店

	10	割合	20	割合	30	割合	40	割合	50	割合	64	割合	69	割合	70	割合	80	割合	90	割合	全体数	割合
1と回答	0	0.0%	1	0.6%	0	0.0%	3	0.8%	4	1.0%	2	0.8%	0	0.0%	1	0.2%	1	0.4%	0	0.0%	12	0.5%
男性	0	0.0%	0	0.0%	0	0.0%	1	0.3%	3	0.7%	1	0.4%	0	0.0%	0	0.0%	0	0.0%	0	0.0%	5	0.2%
女性	0	0.0%	1	0.3%	0	0.0%	4	0.6%	7	0.8%	3	0.6%	0	0.0%	1	0.1%	1	0.2%	0	0.0%	17	0.3%
男女合計	0	0.0%	1	0.3%	0	0.0%	4	0.6%	7	0.8%	3	0.6%	0	0.0%	1	0.1%	1	0.2%	0	0.0%	17	0.3%
2と回答	0	0.0%	1	0.6%	1	0.4%	6	1.6%	4	1.0%	2	0.8%	2	0.7%	1	0.2%	1	0.4%	0	0.0%	18	0.7%
男性	2	1.6%	0	0.0%	0	0.0%	1	0.3%	0	0.0%	0	0.0%	0	0.0%	1	0.2%	0	0.0%	1	1.2%	5	0.2%
女性	0	0.0%	1	0.6%	1	0.4%	6	1.6%	4	1.0%	2	0.8%	2	0.7%	1	0.2%	1	0.4%	0	0.0%	18	0.7%
男女合計	2	0.8%	1	0.3%	1	0.2%	7	1.0%	4	0.5%	2	0.4%	2	0.3%	2	0.2%	1	0.2%	1	0.8%	23	0.4%
3と回答	1	0.8%	7	4.2%	4	1.6%	5	1.3%	5	1.3%	3	1.1%	5	1.8%	0	0.0%	2	0.7%	0	0.0%	32	1.2%
男性	2	1.6%	2	1.1%	1	0.4%	5	1.5%	7	1.6%	3	1.2%	2	0.7%	2	0.4%	1	0.3%	0	0.0%	25	0.9%
女性	0	0.0%	5	2.6%	5	1.0%	10	1.4%	12	1.4%	6	1.1%	7	1.2%	2	0.2%	3	0.5%	0	0.0%	37	1.0%
男女合計	3	1.2%	9	2.6%	5	1.0%	10	1.4%	12	1.4%	6	1.1%	7	1.2%	2	0.2%	3	0.5%	0	0.0%	37	1.0%
4と回答	6	5.0%	9	5.4%	14	5.6%	11	2.9%	10	2.6%	7	2.7%	17	6.0%	13	2.6%	5	1.8%	0	0.0%	92	3.5%
男性	2	1.6%	11	6.1%	11	4.5%	13	3.8%	13	2.9%	4	1.5%	4	1.3%	6	1.2%	1	0.3%	0	0.0%	65	2.3%
女性	8	3.3%	20	5.8%	25	5.0%	24	3.4%	23	2.8%	11	2.1%	21	3.6%	19	1.9%	6	1.0%	0	0.0%	157	2.9%
男女合計	8	3.3%	20	5.8%	25	5.0%	24	3.4%	23	2.8%	11	2.1%	21	3.6%	19	1.9%	6	1.0%	0	0.0%	157	2.9%
5と回答	60	50.4%	72	43.4%	110	43.8%	160	42.8%	154	39.3%	110	41.8%	94	33.0%	158	31.8%	50	18.5%	6	15.8%	974	36.7%
男性	68	54.8%	73	40.8%	115	46.7%	162	47.6%	172	39.0%	101	38.8%	113	36.9%	113	22.2%	74	22.9%	12	14.5%	1003	35.7%
女性	128	52.7%	145	42.0%	225	45.3%	322	45.1%	326	39.1%	211	40.3%	207	35.0%	271	26.9%	124	20.9%	18	14.9%	1977	36.2%
男女合計	128	52.7%	145	42.0%	225	45.3%	322	45.1%	326	39.1%	211	40.3%	207	35.0%	271	26.9%	124	20.9%	18	14.9%	1977	36.2%
6と回答	44	37.0%	52	31.3%	82	32.7%	119	31.8%	138	35.2%	89	33.8%	87	30.5%	161	32.4%	79	29.2%	12	31.6%	863	32.5%
男性	40	32.3%	63	35.2%	92	37.4%	116	34.1%	172	39.0%	92	35.4%	90	29.4%	167	32.8%	97	30.0%	34	41.0%	963	34.3%
女性	84	34.6%	115	33.3%	174	35.0%	235	32.9%	310	37.2%	181	34.6%	177	29.9%	328	32.6%	176	29.6%	46	38.0%	1826	33.4%
男女合計	84	34.6%	115	33.3%	174	35.0%	235	32.9%	310	37.2%	181	34.6%	177	29.9%	328	32.6%	176	29.6%	46	38.0%	1826	33.4%
無回答	8	6.7%	24	14.5%	40	15.9%	70	18.7%	77	19.6%	50	19.0%	80	28.1%	163	32.8%	133	49.1%	20	52.6%	665	25.0%
男性	10	8.1%	30	16.8%	27	11.0%	42	12.4%	74	16.8%	59	22.7%	97	31.7%	220	43.2%	150	46.4%	36	43.4%	745	26.5%
女性	18	7.4%	54	15.7%	67	13.5%	112	15.7%	151	18.1%	109	20.8%	177	29.9%	383	38.1%	283	47.6%	56	46.3%	1410	25.8%
男女合計	18	7.4%	54	15.7%	67	13.5%	112	15.7%	151	18.1%	109	20.8%	177	29.9%	383	38.1%	283	47.6%	56	46.3%	1410	25.8%
全体(人)	119		166		251		374		392		263		285		497		271		38		2656	
男性	124		179		246		340		441		260		306		509		323		83		2811	
女性	243		345		497		714		833		523		591		1006		594		121		5467	
男女合計	243		345		497		714		833		523		591		1006		594		121		5467	

○遊技場

	10	割合	20	割合	30	割合	40	割合	50	割合	64	割合	69	割合	70	割合	80	割合	90	割合	全体数	割合
1と回答	0	0.0%	1	0.6%	1	0.4%	2	0.5%	2	0.5%	2	0.8%	4	1.4%	1	0.2%	0	0.0%	0	0.0%	13	0.5%
男性	0	0.0%	0	0.0%	0	0.0%	1	0.3%	3	0.7%	0	0.0%	0	0.0%	0	0.0%	0	0.0%	0	0.0%	4	0.1%
女性	0	0.0%	1	0.3%	1	0.2%	3	0.4%	5	0.6%	2	0.4%	4	0.7%	1	0.1%	0	0.0%	0	0.0%	17	0.3%
男女合計	0	0.0%	1	0.3%	1	0.2%	3	0.4%	5	0.6%	2	0.4%	4	0.7%	1	0.1%	0	0.0%	0	0.0%	17	0.3%
2と回答	0	0.0%	2	1.2%	5	2.0%	9	2.4%	5	1.3%	4	1.5%	3	1.1%	5	1.0%	1	0.4%	0	0.0%	34	1.3%
男性	0	0.0%	1	0.6%	0	0.0%	1	0.3%	0	0.0%	0	0.0%	0	0.0%	0	0.0%	0	0.0%	0	0.0%	2	0.1%
女性	0	0.0%	3	0.9%	5	1.0%	10	1.4%	5	0.6%	4	0.8%	3	0.5%	5	0.5%	1	0.2%	0	0.0%	36	0.7%
男女合計	0	0.0%	3	0.9%	5	1.0%	10	1.4%	5	0.6%	4	0.8%	3	0.5%	5	0.5%	1	0.2%	0	0.0%	36	0.7%
3と回答	0	0.0%	5	3.0%	3	1.2%	7	1.9%	10	2.6%	4	1.5%	8	2.8%	5	1.0%	0	0.0%	0	0.0%	42	1.6%
男性	0	0.0%	0	0.0%	0	0.0%	1	0.3%	0	0.0%	3	1.2%	1	0.3%	2	0.4%	0	0.0%	0	0.0%	7	0.2%
女性	0	0.0%	5	1.4%	3	0.6%	8	1.1%	10	1.2%	7	1.3%	9	1.5%	7	0.7%	0	0.0%	0	0.0%	49	0.9%
男女合計	0	0.0%	5	1.4%	3	0.6%	8	1.1%	10	1.2%	7	1.3%	9	1.5%	7	0.7%	0	0.0%	0	0.0%	49	0.9%
4と回答	4	3.4%	6	3.6%	4	1.6%	8	2.1%	6	1.5%	6	2.3%	2	0.7%	5	1.0%	1	0.4%	0	0.0%	42	1.6%
男性	0	0.0%	2	1.1%	4	1.6%	6	1.8%	2	0.5%	2	0.8%	0	0.0%	3	0.6%	1	0.3%	0	0.0%	20	0.7%
女性	4	1.6%	8	2.3%	8	1.6%	14	2.0%	8	1.5%	8	1.5%	2	0.3%	8	0.8%	2	0.3%	0	0.0%	62	1.1%
男女合計	4	1.6%	8	2.3%	8	1.6%	14	2.0%	8	1.5%	8	1.5%	2	0.3%	8	0.8%	2	0.3%	0	0.0%	62	1.1%
5と回答	39	32.8%	42	25.3%	67	26.7%	93	24.9%	71	18.1%	54	20.5%	56	19.6%	109	21.9%	37	13.7%	6	15.8%	574	21.6%
男性	42	33.9%	32	17.9%	64	26.0%	94	27.6%	73	16.6%	52	20.0%	66	21.6%	77	15.1%	59	18.3%	9	10.8%	568	20.2%
女性	81	33.3%	74	21.4%	131	26.4%	187	26.2%	144	17.3%	106	20.3%	122	20.6%	186	18.5%	96	16.2%	15	12.4%	1142	20.9%
男女合計	81	33.3%	74	21.4%	131	26.4%	187	26.2%	144	17.3%	106	20.3%	122	20.6%	186	18.5%	96	16.2%	15	12.4%	1142	20.9%
6と回答	66	55.5%	85	51.2%	130	51.8%	186	49.7%	216	55.1%	137	52.1%	124	43.5%	197	39.6%	95	35.1%	12	31.6%	1248	47.0%
男性	70	56.5%	113	63.1%	151	61.4%	192	56.5%	284	64.4%	138	53.1%	137	44.8%	193	37.9%	109	33.7%	38	45.8%	1425	50.7%
女性	136	56.0%	198	57.4%	281	56.5%	378	52.9%	500	60.0%	275	52.6%	261	44.2%	390	38.8%	204	34.3%	50	41.3%	2673	48.9%
男女合計	136	56.0%	198	57.4%	281	56.5%	378	52.9%	500	60.0%	275	52.6%	261	44.2%	390	38.8%	204	34.3%	50	41.3%	2673	48.9%
無回答	10	8.4%	25	15.1%	41	16.3%	69	18.4%	82	20.9%	56	21.3%	88	30.9%	175	35.2%	137	50.6%	20	52.6%	703	26.5%
男性	12	9.7%	31	17.3%	27	11.0%	45	13.2%	79	17.9%	65	25.0%	102	33.3%	234	46.0%	154	47.7%	36	43.4%	785	27.9%
女性	22	9.1%	56	16.2%	68	13.7%	114	16.0%	161	19.3%	121	23.1%	190	32.1%	409	40.7%	291	49.0%				

○医療機関

	10	割合	20	割合	30	割合	40	割合	50	割合	64	割合	69	割合	70	割合	80	割合	90	割合	全体数	割合		
1と回答	0	0.0%	0	0.0%	0	0.0%	0	0.0%	1	0.3%	2	0.8%	0	0.0%	0	0.0%	0	0.0%	0	0.0%	3	0.1%		
男性	0	0.0%	0	0.0%	0	0.0%	1	0.3%	1	0.2%	0	0.0%	0	0.0%	0	0.0%	0	0.0%	0	0.0%	2	0.1%		
女性	0	0.0%	0	0.0%	0	0.0%	1	0.3%	1	0.2%	0	0.0%	0	0.0%	0	0.0%	0	0.0%	0	0.0%	2	0.1%		
男女合計	0	0.0%	0	0.0%	0	0.0%	1	0.1%	2	0.2%	2	0.4%	0	0.0%	0	0.0%	0	0.0%	0	0.0%	5	0.1%		
2と回答	0	0.0%	0	0.0%	1	0.4%	1	0.3%	1	0.3%	0	0.0%	0	0.0%	2	0.7%	0	0.0%	0	0.0%	0	0.0%	5	0.2%
男性	0	0.0%	0	0.0%	1	0.4%	1	0.3%	1	0.3%	0	0.0%	0	0.0%	2	0.7%	0	0.0%	0	0.0%	0	0.0%	6	0.2%
女性	0	0.0%	0	0.0%	2	0.8%	1	0.3%	0	0.0%	1	0.4%	0	0.0%	1	0.2%	1	0.3%	0	0.0%	0	0.0%	6	0.2%
男女合計	0	0.0%	0	0.0%	3	0.6%	2	0.3%	1	0.1%	1	0.2%	2	0.3%	1	0.1%	1	0.2%	0	0.0%	0	0.0%	11	0.2%
3と回答	0	0.0%	1	0.6%	2	0.8%	1	0.3%	0	0.0%	1	0.4%	0	0.0%	1	0.2%	0	0.0%	0	0.0%	0	0.0%	6	0.2%
男性	0	0.0%	0	0.0%	1	0.4%	1	0.3%	1	0.2%	0	0.0%	1	0.3%	2	0.4%	0	0.0%	0	0.0%	0	0.0%	6	0.2%
女性	0	0.0%	1	0.3%	3	0.6%	2	0.3%	1	0.2%	1	0.2%	1	0.2%	3	0.3%	0	0.0%	0	0.0%	0	0.0%	12	0.2%
男女合計	0	0.0%	1	0.3%	3	0.6%	2	0.3%	1	0.1%	1	0.2%	1	0.2%	3	0.3%	0	0.0%	0	0.0%	0	0.0%	12	0.2%
4と回答	0	0.0%	1	0.6%	4	1.6%	7	1.9%	6	1.5%	10	3.8%	10	3.5%	22	4.4%	13	4.8%	3	7.9%			76	2.9%
男性	0	0.0%	3	1.7%	4	0.0%	5	1.5%	7	1.6%	4	1.5%	7	2.3%	21	4.1%	6	1.9%	0	0.0%			53	1.9%
女性	0	0.0%	4	1.2%	4	0.8%	12	1.7%	13	1.6%	14	2.7%	17	2.9%	43	4.3%	19	3.2%	3	2.5%			129	2.4%
男女合計	0	0.0%	4	1.2%	4	0.8%	12	1.7%	13	1.6%	14	2.7%	17	2.9%	43	4.3%	19	3.2%	3	2.5%			129	2.4%
5と回答	54	45.4%	75	45.2%	100	39.8%	181	48.4%	191	48.7%	145	55.1%	148	51.9%	235	47.3%	88	32.5%	13	34.2%			1230	46.3%
男性	62	50.0%	83	46.4%	136	55.3%	194	57.1%	239	54.2%	144	55.4%	156	51.0%	198	38.9%	120	37.2%	25	30.1%			1357	48.3%
女性	116	47.7%	158	45.8%	236	47.5%	375	52.5%	430	51.6%	289	55.3%	304	51.4%	433	43.0%	208	35.0%	38	31.4%			2587	47.3%
男女合計	116	47.7%	158	45.8%	236	47.5%	375	52.5%	430	51.6%	289	55.3%	304	51.4%	433	43.0%	208	35.0%	38	31.4%			2587	47.3%
6と回答	54	45.4%	64	38.6%	102	40.6%	113	30.2%	107	27.3%	51	19.4%	42	14.7%	70	14.1%	40	14.8%	5	13.2%			648	24.4%
男性	50	40.3%	61	34.1%	80	32.5%	97	28.5%	116	26.3%	48	18.5%	52	17.0%	72	14.1%	47	14.6%	26	31.3%			649	23.1%
女性	104	42.8%	125	36.2%	182	36.6%	210	29.4%	223	26.8%	99	18.9%	94	15.9%	142	14.1%	87	14.6%	31	25.6%			1297	23.7%
男女合計	104	42.8%	125	36.2%	182	36.6%	210	29.4%	223	26.8%	99	18.9%	94	15.9%	142	14.1%	87	14.6%	31	25.6%			1297	23.7%
無回答	11	9.2%	25	15.1%	42	16.7%	71	19.0%	86	21.9%	54	20.5%	83	29.1%	169	34.0%	130	48.0%	17	44.7%			688	25.9%
男性	12	9.7%	32	17.9%	27	11.0%	41	12.1%	77	17.5%	63	24.2%	90	29.4%	215	42.2%	149	46.1%	32	38.6%			738	26.3%
女性	23	9.5%	57	16.5%	69	13.9%	112	15.7%	163	19.6%	117	22.4%	173	29.3%	384	38.2%	279	47.0%	49	40.5%			1426	26.1%
男女合計	23	9.5%	57	16.5%	69	13.9%	112	15.7%	163	19.6%	117	22.4%	173	29.3%	384	38.2%	279	47.0%	49	40.5%			1426	26.1%
全体(人)	119		166		251		374		392		263		285		497		271		38				2656	
男性	124		179		246		340		441		260		306		509		323		83				2811	
女性	243		345		497		714		833		523		591		1006		594		121				5467	

○公共交通機関

	10	割合	20	割合	30	割合	40	割合	50	割合	64	割合	69	割合	70	割合	80	割合	90	割合	全体数	割合		
1と回答	0	0.0%	0	0.0%	0	0.0%	1	0.3%	0	0.0%	2	0.8%	0	0.0%	0	0.0%	0	0.0%	0	0.0%	3	0.1%		
男性	0	0.0%	0	0.0%	0	0.0%	1	0.3%	1	0.2%	0	0.0%	0	0.0%	0	0.0%	0	0.0%	0	0.0%	2	0.1%		
女性	0	0.0%	0	0.0%	0	0.0%	1	0.3%	1	0.2%	0	0.0%	0	0.0%	0	0.0%	0	0.0%	0	0.0%	2	0.1%		
男女合計	0	0.0%	0	0.0%	0	0.0%	2	0.3%	1	0.1%	2	0.4%	0	0.0%	0	0.0%	0	0.0%	0	0.0%	5	0.1%		
2と回答	1	0.8%	1	0.6%	2	0.8%	1	0.3%	4	1.0%	1	0.4%	0	0.0%	0	0.0%	1	0.4%	0	0.0%			11	0.4%
男性	0	0.0%	0	0.0%	0	0.0%	0	0.0%	0	0.0%	2	0.8%	1	0.3%	0	0.0%	0	0.0%	0	0.0%			3	0.1%
女性	1	0.4%	1	0.3%	2	0.4%	1	0.1%	4	0.5%	3	0.6%	1	0.2%	0	0.0%	1	0.2%	0	0.0%			14	0.3%
男女合計	1	0.4%	1	0.3%	2	0.4%	1	0.1%	4	0.5%	3	0.6%	1	0.2%	0	0.0%	1	0.2%	0	0.0%			14	0.3%
3と回答	0	0.0%	2	1.2%	0	0.0%	2	0.5%	0	0.0%	0	0.0%	1	0.4%	0	0.0%	0	0.0%	0	0.0%			5	0.2%
男性	0	0.0%	1	0.6%	0	0.0%	1	0.3%	1	0.2%	1	0.4%	0	0.0%	0	0.0%	3	0.9%	0	0.0%			7	0.2%
女性	0	0.0%	3	0.9%	0	0.0%	3	0.4%	1	0.1%	1	0.2%	1	0.2%	0	0.0%	3	0.5%	0	0.0%			12	0.2%
男女合計	0	0.0%	3	0.9%	0	0.0%	3	0.4%	1	0.1%	1	0.2%	1	0.2%	0	0.0%	3	0.5%	0	0.0%			12	0.2%
4と回答	1	0.8%	1	0.6%	0	0.0%	3	0.8%	3	0.8%	4	1.5%	2	0.7%	6	1.2%	4	1.5%	0	0.0%			24	0.9%
男性	4	3.2%	5	2.8%	1	0.4%	6	1.8%	4	0.9%	1	0.4%	2	0.7%	2	0.4%	1	0.3%	0	0.0%			26	0.9%
女性	5	2.1%	6	1.7%	1	0.2%	9	1.3%	7	0.8%	5	1.0%	4	0.7%	8	0.8%	5	0.8%	0	0.0%			50	0.9%
男女合計	5	2.1%	6	1.7%	1	0.2%	9	1.3%	7	0.8%	5	1.0%	4	0.7%	8	0.8%	5	0.8%	0	0.0%			50	0.9%
5と回答	58	48.7%	61	36.7%	83	33.1%	129	34.5%	119	30.4%	91	34.6%	75	26.3%	150	30.2%	56	20.7%	7	18.4%			829	31.2%
男性	72	58.1%	60	33.5%	78	31.7%	124	36.5%	134	30.4%	74	28.5%	92	30.1%	115	22.6%	78	24.1%	12	14.5%			839	29.8%
女性	130	53.5%	121	35.1%	161	32.4%	253	35.4%	253	30.4%	165	31.5%	167	28.3%	265	26.3%	134	22.6%	19	15.7%			1668	30.5%
男女合計	130	53.5%	121	35.1%	161	32.4%	253	35.4%	253	30.4%	165	31.5%	167	28.3%	265	26.3%	134	22.6%	19	15.7%			1668	30.5%
6と回答	48	40.3%	76	45.8%	124	49.4%	166	44.4%	184	46.9%	111	42.2%	112	39.3%	159	32.0%	74	27.3%	10	26.3%			1064	40.1%
男性	36	29.0%	83	46.4%	140	56.9%	166	48.8%	221	50.1%	115	44.2%	114	37.3%	158	31.0%	92	28.5%	36	43.4%			1161	41.3%
女性	84	34.6%	159	46.1%	264	53.1%	332	46.5%	405	48.6%	226	43.2%	226	38.2%	317	31.5%	166	27.9%	46	38.0%			2225	40.7%
男女合計	84	34.6%	159	46.1%	264	53.1%	332	46.5%	405	48.6%	226	43.2%	226	38.2%	317	31.5%	166	27.9%	46	38.0%			2225	40.7%
無回答	11	9.2%	25	15.1%	42	16.7%	72	19.3%	82	20.9%	54	20.5%	95	33.3%	182	36.6%	136	50.2%	21	55.3%			720	27.1%
男性	12	9.7%	30	16.8%	27	11.0%	42	12.4%	80	18.1%	67	25.8%	97	31.7%	234	46.0%	149	46.1%	35	42.2%			773	27.5%
女性	23	9.5%	55	15.9%	69	13.9%	114	16.0%	162	19.4%	121	23.1%	192	32.5%	416	41.4%	285	48.0%	56	46.3%			1493	27.3%
男女合計	23	9.5%	55	15.9%	69	13.9%	114	16.0%	162	19.4%	121	23.1%	192	32.5%	416	41.4%	285	48.0%	56	46.3%			1493	27.3%
全体(人)	119		166		251		374		392		263		285											

○子供が利用する屋外の空間

	10	割合	20	割合	30	割合	40	割合	50	割合	64	割合	69	割合	70	割合	80	割合	90	割合	全体数	割合
1と回答	0	0.0%	2	1.2%	0	0.0%	1	0.3%	0	0.0%	3	1.1%	1	0.4%	0	0.0%	0	0.0%	0	0.0%	7	0.3%
男性	0	0.0%	0	0.0%	0	0.0%	0	0.0%	0	0.0%	1	0.4%	0	0.0%	1	0.2%	0	0.0%	0	0.0%	3	0.1%
女性	0	0.0%	2	0.6%	0	0.0%	1	0.1%	1	0.1%	4	0.8%	1	0.2%	1	0.1%	0	0.0%	0	0.0%	10	0.2%
男女合計	0	0.0%	2	0.6%	0	0.0%	1	0.1%	1	0.1%	4	0.8%	1	0.2%	1	0.1%	0	0.0%	0	0.0%	10	0.2%
2と回答	0	0.0%	0	0.0%	0	0.0%	2	0.5%	1	0.3%	2	0.8%	2	0.7%	0	0.0%	0	0.0%	0	0.0%	7	0.3%
男性	0	0.0%	0	0.0%	0	0.0%	0	0.0%	0	0.0%	0	0.0%	0	0.0%	0	0.0%	0	0.0%	0	0.0%	3	0.1%
女性	0	0.0%	0	0.0%	0	0.0%	2	0.5%	1	0.3%	2	0.8%	2	0.7%	0	0.0%	0	0.0%	0	0.0%	10	0.2%
男女合計	0	0.0%	0	0.0%	0	0.0%	2	0.5%	1	0.3%	4	1.2%	4	1.2%	0	0.0%	0	0.0%	0	0.0%	10	0.2%
3と回答	0	0.0%	2	1.2%	0	0.0%	1	0.3%	0	0.0%	0	0.0%	1	0.4%	0	0.0%	1	0.4%	0	0.0%	5	0.2%
男性	0	0.0%	0	0.0%	1	0.4%	4	1.2%	0	0.0%	3	1.2%	0	0.0%	0	0.0%	0	0.0%	0	0.0%	8	0.3%
女性	0	0.0%	2	0.6%	1	0.2%	5	0.7%	0	0.0%	3	0.6%	1	0.2%	0	0.0%	1	0.2%	0	0.0%	13	0.2%
男女合計	0	0.0%	2	0.6%	1	0.2%	5	0.7%	0	0.0%	3	0.6%	1	0.2%	0	0.0%	1	0.2%	0	0.0%	13	0.2%
4と回答	1	0.8%	1	0.6%	5	2.0%	6	1.6%	1	0.3%	5	1.9%	2	0.7%	1	0.2%	0	0.0%	0	0.0%	22	0.8%
男性	1	0.8%	3	1.7%	5	2.0%	7	2.1%	1	0.2%	0	0.0%	2	0.7%	1	0.2%	0	0.0%	0	0.0%	20	0.7%
女性	2	0.8%	4	1.2%	10	2.0%	13	1.8%	2	0.2%	5	1.0%	4	0.7%	2	0.2%	0	0.0%	0	0.0%	42	0.8%
男女合計	2	0.8%	4	1.2%	10	2.0%	13	1.8%	2	0.2%	5	1.0%	4	0.7%	2	0.2%	0	0.0%	0	0.0%	42	0.8%
5と回答	49	41.2%	53	31.9%	88	35.1%	135	36.1%	107	27.3%	75	28.5%	82	28.8%	147	29.6%	48	17.7%	5	13.2%	789	29.7%
男性	59	47.6%	49	27.4%	114	46.3%	139	40.9%	117	26.5%	62	23.8%	77	25.2%	93	18.3%	65	20.1%	10	12.0%	785	27.9%
女性	108	44.4%	102	29.6%	202	40.6%	274	38.4%	224	26.9%	137	26.2%	159	26.9%	240	23.9%	113	19.0%	15	12.4%	1574	28.8%
男女合計	108	44.4%	102	29.6%	202	40.6%	274	38.4%	224	26.9%	137	26.2%	159	26.9%	240	23.9%	113	19.0%	15	12.4%	1574	28.8%
6と回答	57	47.9%	82	49.4%	115	45.8%	156	41.7%	189	48.2%	120	45.6%	100	35.1%	152	30.6%	79	29.2%	13	34.2%	1063	40.0%
男性	51	41.1%	96	53.6%	97	39.4%	145	42.6%	238	54.0%	121	46.5%	121	39.5%	164	32.2%	98	30.3%	34	41.0%	1165	41.4%
女性	108	44.4%	178	51.6%	212	42.7%	301	42.2%	427	51.3%	241	46.1%	221	37.4%	316	31.4%	177	29.8%	47	38.8%	2228	40.8%
男女合計	108	44.4%	178	51.6%	212	42.7%	301	42.2%	427	51.3%	241	46.1%	221	37.4%	316	31.4%	177	29.8%	47	38.8%	2228	40.8%
無回答	12	10.1%	26	15.7%	43	17.1%	73	19.5%	94	24.0%	58	22.1%	97	34.0%	197	39.6%	143	52.8%	20	52.6%	763	28.7%
男性	13	10.5%	31	17.3%	29	11.8%	44	12.9%	83	18.8%	73	28.1%	105	34.3%	250	49.1%	160	49.5%	39	47.0%	827	29.4%
女性	25	10.3%	57	16.5%	72	14.5%	117	16.4%	177	21.2%	131	25.0%	202	34.2%	447	44.4%	303	51.0%	59	48.8%	1590	29.1%
男女合計	25	10.3%	57	16.5%	72	14.5%	117	16.4%	177	21.2%	131	25.0%	202	34.2%	447	44.4%	303	51.0%	59	48.8%	1590	29.1%
全体(人)	119		166		251		374		392		263		285		497		271		38		2656	
男性	124		179		246		340		441		260		306		509		323		83		2811	
女性	243		345		497		714		833		523		591		1006		594		121		5467	

○健康増進施設

	10	割合	20	割合	30	割合	40	割合	50	割合	64	割合	69	割合	70	割合	80	割合	90	割合	全体数	割合
1と回答	0	0.0%	0	0.0%	1	0.4%	0	0.0%	0	0.0%	1	0.4%	0	0.0%	1	0.2%	0	0.0%	0	0.0%	3	0.1%
男性	0	0.0%	0	0.0%	0	0.0%	0	0.0%	0	0.0%	0	0.0%	0	0.0%	0	0.0%	0	0.0%	0	0.0%	0	0.0%
女性	0	0.0%	0	0.0%	1	0.2%	0	0.0%	0	0.0%	1	0.2%	0	0.0%	1	0.1%	0	0.0%	0	0.0%	3	0.1%
男女合計	0	0.0%	0	0.0%	1	0.2%	0	0.0%	0	0.0%	1	0.2%	0	0.0%	1	0.1%	0	0.0%	0	0.0%	3	0.1%
2と回答	0	0.0%	1	0.6%	0	0.0%	1	0.3%	2	0.5%	2	0.8%	1	0.4%	0	0.0%	0	0.0%	0	0.0%	7	0.3%
男性	0	0.0%	0	0.0%	0	0.0%	1	0.3%	0	0.0%	1	0.4%	0	0.0%	0	0.0%	0	0.0%	0	0.0%	3	0.1%
女性	0	0.0%	1	0.3%	0	0.0%	1	0.3%	2	0.5%	2	0.8%	1	0.4%	0	0.0%	0	0.0%	0	0.0%	10	0.2%
男女合計	0	0.0%	1	0.3%	0	0.0%	2	0.3%	2	0.2%	3	0.6%	1	0.2%	1	0.1%	0	0.0%	0	0.0%	10	0.2%
3と回答	0	0.0%	1	0.6%	0	0.0%	2	0.5%	1	0.3%	1	0.4%	3	1.1%	3	0.6%	0	0.0%	0	0.0%	11	0.4%
男性	0	0.0%	0	0.0%	0	0.0%	0	0.0%	0	0.0%	0	0.0%	0	0.0%	2	0.4%	0	0.0%	0	0.0%	2	0.1%
女性	0	0.0%	1	0.3%	0	0.0%	2	0.3%	1	0.1%	1	0.2%	3	0.5%	5	0.5%	0	0.0%	0	0.0%	13	0.2%
男女合計	0	0.0%	1	0.3%	0	0.0%	2	0.3%	1	0.1%	1	0.2%	3	0.5%	5	0.5%	0	0.0%	0	0.0%	13	0.2%
4と回答	0	0.0%	0	0.0%	0	0.0%	2	0.5%	2	0.5%	1	0.4%	2	0.7%	1	0.2%	0	0.0%	0	0.0%	8	0.3%
男性	1	0.8%	0	0.0%	0	0.0%	2	0.6%	0	0.0%	2	0.8%	1	0.3%	1	0.2%	0	0.0%	0	0.0%	7	0.2%
女性	1	0.4%	0	0.0%	0	0.0%	4	0.6%	2	0.2%	3	0.6%	3	0.5%	2	0.2%	0	0.0%	0	0.0%	15	0.3%
男女合計	1	0.4%	0	0.0%	0	0.0%	4	0.6%	2	0.2%	3	0.6%	3	0.5%	2	0.2%	0	0.0%	0	0.0%	15	0.3%
5と回答	37	31.1%	48	28.9%	72	28.7%	107	28.6%	82	20.9%	57	21.7%	72	25.3%	122	24.5%	44	16.2%	6	15.8%	647	24.4%
男性	43	34.7%	39	21.8%	74	30.1%	102	30.0%	99	22.4%	56	21.5%	92	30.1%	92	18.1%	75	23.2%	13	15.7%	685	24.4%
女性	80	32.9%	87	25.2%	146	29.4%	209	29.3%	181	21.7%	113	21.6%	164	27.7%	214	21.3%	119	20.0%	19	15.7%	1332	24.4%
男女合計	69	58.0%	88	53.0%	132	52.6%	185	49.5%	212	54.1%	139	52.9%	113	39.6%	169	34.0%	81	29.9%	12	31.6%	1200	45.2%
男性	66	53.2%	107	59.8%	144	58.5%	186	54.7%	258	58.5%	126	48.5%	106	34.6%	167	32.8%	89	27.6%	31	37.3%	1280	45.5%
女性	135	55.6%	195	56.5%	276	55.5%	371	52.0%	470	56.4%	265	50.7%	219	37.1%	336	33.4%	170	28.6%	43	35.5%	2480	45.4%
男女合計	135	55.6%	195	56.5%	276	55.5%	371	52.0%	470	56.4%	265	50.7%	219	37.1%	336	33.4%	170	28.6%	43	35.5%	2480	45.4%
無回答	13	10.9%	28	16.9%	46	18.3%	77	20.6%	93	23.7%	62	23.6%	94	33.0%	201	40.4%	146	53.9%	20	52.6%	780	29.4%
男性	14	11.3%	33	18.4%	28	11.4%	49	14.4%	84	19.0%	75	28.8%	107	35.0%	246	48.3%	159	49.2%	39	47.0%	834	29.7%
女性	27	11.1%	61	17.7%	74	14.9%	126	17.6%	177	21.2%	137	26.2%	201	34.0%	447	44.4%	305	51.3%	59	48.8%	1614	29.5%
男女合計	27	11.1%	61	17.7%	74	14.9%	126	17.6%	177	21.2%	137	26.2%	201	34.0%	447	44.4%	305	51.3%	59	48.8%	1614	29.5%
全体(人)	119		166		251		374		392		263		285		497		271		38		2656	
男性	124		179		246		340		441		260		306		509		323		83		2811	
女性	243		345		497		714		833		523		591		1006		594		121		5467	

14 「COPD（慢性閉塞性肺疾患）」の認知度（調査票 問14）

問14 あなたは、「COPD（慢性閉塞性肺疾患）」という病気を知っていますか。

1 知っている 2 知らない

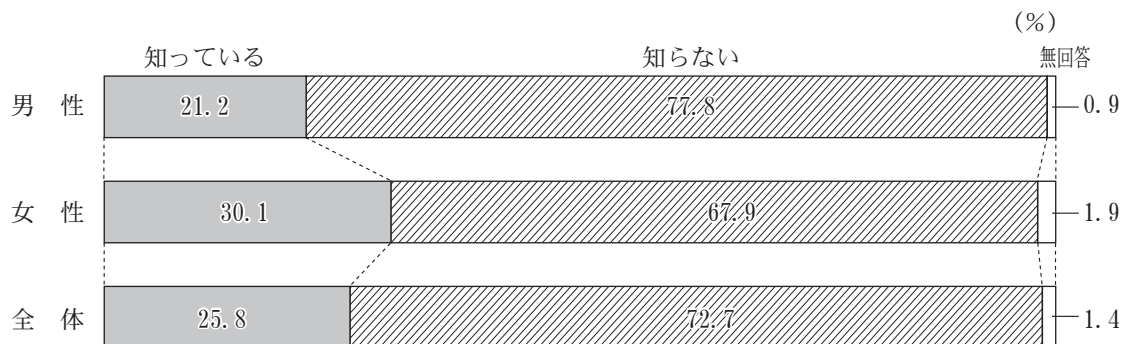

	10	割合	20	割合	30	割合	40	割合	50	割合	64	割合	69	割合	70	割合	80	割合	90	割合	全体数	割合
1と回答																						
男性	7	5.9%	24	14.5%	63	25.1%	91	24.3%	97	24.7%	73	27.8%	61	21.4%	97	19.5%	45	16.6%	6	15.8%	564	21.2%
女性	16	12.9%	57	31.8%	88	35.8%	129	37.9%	169	38.3%	91	35.0%	106	34.6%	131	25.7%	55	17.0%	5	6.0%	847	30.1%
男女合計	23	9.5%	81	23.5%	151	30.4%	220	30.8%	266	31.9%	164	31.4%	167	28.3%	228	22.7%	100	16.8%	11	9.1%	1411	25.8%
2と回答																						
男性	112	94.1%	141	84.9%	188	74.9%	280	74.9%	293	74.7%	188	71.5%	224	78.6%	393	79.1%	218	80.4%	30	78.9%	2067	77.8%
女性	107	86.3%	121	67.6%	158	64.2%	211	62.1%	270	61.2%	165	63.5%	196	64.1%	360	70.7%	249	77.1%	73	88.0%	1910	67.9%
男女合計	219	90.1%	262	75.9%	346	69.6%	491	68.8%	563	67.6%	353	67.5%	420	71.1%	753	74.9%	467	78.6%	103	85.1%	3977	72.7%
無回答																						
男性	0	0.0%	1	0.6%	0	0.0%	3	0.8%	2	0.5%	2	0.8%	0	0.0%	7	1.4%	8	3.0%	2	5.3%	25	0.9%
女性	1	0.8%	1	0.6%	0	0.0%	0	0.0%	2	0.5%	4	1.5%	4	1.3%	18	3.5%	19	5.9%	5	6.0%	54	1.9%
男女合計	1	0.4%	2	0.6%	0	0.0%	3	0.4%	4	0.5%	6	1.1%	4	0.7%	25	2.5%	27	4.5%	7	5.8%	79	1.4%
全体(人)																						
男性	119		166		251		374		392		263		285		497		271		38		2656	
女性	124		179		246		340		441		260		306		509		323		83		2811	
男女合計	243		345		497		714		833		523		591		1006		594		121		5467	

県 北

	10	割合	20	割合	30	割合	40	割合	50	割合	64	割合	69	割合	70～	割合	全体数	割合
1と回答																		
男性	3	8.6%	8	16.7%	23	25.0%	27	21.1%	33	28.0%	15	24.2%	12	20.3%	32	16.8%	153	20.9%
女性	3	8.1%	17	33.3%	30	34.1%	40	38.8%	52	38.5%	21	33.3%	36	43.9%	41	17.6%	240	30.3%
男女合計	6	8.3%	25	25.3%	53	29.4%	67	29.0%	85	33.6%	36	28.8%	48	34.0%	73	17.3%	393	25.8%
2と回答																		
男性	32	91.4%	39	81.3%	69	75.0%	100	78.1%	84	71.2%	47	75.8%	47	79.7%	154	81.1%	572	78.1%
女性	33	89.2%	34	66.7%	58	65.9%	63	61.2%	83	61.5%	41	65.1%	44	53.7%	183	78.5%	539	68.1%
男女合計	65	90.3%	73	73.7%	127	70.6%	163	70.6%	167	66.0%	88	70.4%	91	64.5%	337	79.7%	1111	72.9%
無回答																		
男性	0	0.0%	1	2.1%	0	0.0%	1	0.8%	1	0.8%	0	0.0%	0	0.0%	4	2.1%	7	1.0%
女性	1	2.7%	0	0.0%	0	0.0%	0	0.0%	0	0.0%	1	1.6%	2	2.4%	9	3.9%	13	1.6%
男女合計	1	1.4%	1	1.0%	0	0.0%	1	0.4%	1	0.4%	1	0.8%	2	1.4%	13	3.1%	20	1.3%
全体(人)																		
男性	35		48		92		128		118		62		59		190		732	
女性	37		51		88		103		135		63		82		233		792	
男女合計	72		99		180		231		253		125		141		423		1524	

県 中

	10	割合	20	割合	30	割合	40	割合	50	割合	64	割合	69	割合	70～	割合	全体数	割合
1と回答																		
男性	1	3.0%	7	17.9%	13	27.1%	21	23.1%	32	29.4%	17	27.0%	11	14.3%	34	17.3%	136	20.7%
女性	6	20.7%	18	35.3%	24	42.9%	31	34.4%	40	38.5%	19	32.8%	13	19.1%	45	19.6%	196	28.6%
男女合計	7	11.3%	25	27.8%	37	35.6%	52	28.7%	72	33.8%	36	29.8%	24	16.6%	79	18.5%	332	24.7%
2と回答																		
男性	32	97.0%	32	82.1%	35	72.9%	70	76.9%	76	69.7%	46	73.0%	66	85.7%	159	80.7%	516	78.5%
女性	23	79.3%	33	64.7%	32	57.1%	59	65.6%	63	60.6%	38	65.5%	54	79.4%	172	74.8%	474	69.1%
男女合計	55	88.7%	65	72.2%	67	64.4%	129	71.3%	139	65.3%	84	69.4%	120	82.8%	331	77.5%	990	73.7%
無回答																		
男性	0	0.0%	0	0.0%	0	0.0%	0	0.0%	1	0.9%	0	0.0%	0	0.0%	4	2.0%	5	0.8%
女性	0	0.0%	0	0.0%	0	0.0%	0	0.0%	1	1.0%	1	1.7%	1	1.5%	13	5.7%	16	2.3%
男女合計	0	0.0%	0	0.0%	0	0.0%	0	0.0%	2	0.9%	1	0.8%	1	0.7%	17	4.0%	21	1.6%
全体(人)																		
男性	33		39		48		91		109		63		77		197		657	
女性	29		51		56		90		104		58		68		230		686	
男女合計	62		90		104		181		213		121		145		427		1343	

県 南

	10	割合	20	割合	30	割合	40	割合	50	割合	64	割合	69	割合	70～	割合	全体数	割合
1と回答																		
男性	0	0.0%	0	0.0%	5	22.7%	11	29.7%	4	11.8%	10	31.3%	6	18.2%	13	15.3%	49	17.9%
女性	1	5.3%	5	29.4%	7	38.9%	10	35.7%	21	45.7%	10	31.3%	11	37.9%	19	19.6%	84	29.4%
男女合計	1	3.8%	5	12.5%	12	30.0%	21	32.3%	25	31.3%	20	31.3%	17	27.4%	32	17.6%	133	23.8%
2と回答																		
男性	7	100.0%	23	100.0%	17	77.3%	26	70.3%	30	88.2%	22	68.8%	27	81.8%	71	83.5%	223	81.7%
女性	18	94.7%	11	64.7%	11	61.1%	18	64.3%	25	54.3%	21	65.6%	18	62.1%	76	78.4%	198	69.2%
男女合計	25	96.2%	34	85.0%	28	70.0%	44	67.7%	55	68.8%	43	67.2%	45	72.6%	147	80.8%	421	75.3%
無回答																		
男性	0	0.0%	0	0.0%	0	0.0%	0	0.0%	0	0.0%	0	0.0%	0	0.0%	1	1.2%	1	0.4%
女性	0	0.0%	1	5.9%	0	0.0%	0	0.0%	0	0.0%	1	3.1%	0	0.0%	2	2.1%	4	1.4%
男女合計	0	0.0%	1	2.5%	0	0.0%	0	0.0%	0	0.0%	1	1.6%	0	0.0%	3	1.6%	5	0.9%
全体(人)																		
男性	7		23		22		37		34		32		33		85		273	
女性	19		17		18		28		46		32		29		97		286	
男女合計	26		40		40		65		80		64		62		182		559	

会 津

	10	割合	20	割合	30	割合	40	割合	50	割合	64	割合	69	割合	70～	割合	全体数	割合
1と回答																		
男性	1	5.0%	4	14.3%	6	20.7%	11	32.4%	16	34.0%	14	28.0%	13	28.9%	19	19.4%	84	23.9%
女性	4	28.6%	8	38.1%	11	34.4%	14	41.2%	28	38.9%	18	41.9%	17	35.4%	18	15.7%	118	31.1%
男女合計	5	14.7%	12	24.5%	17	27.9%	25	36.8%	44	37.0%	32	34.4%	30	32.3%	37	17.4%	202	27.7%
2と回答																		
男性	19	95.0%	24	85.7%	23	79.3%	23	67.6%	31	66.0%	36	72.0%	32	71.1%	77	78.6%	265	75.5%
女性	10	71.4%	13	61.9%	21	65.6%	20	58.8%	43	59.7%	25	58.1%	31	64.6%	93	80.9%	256	67.5%
男女合計	29	85.3%	37	75.5%	44	72.1%	43	63.2%	74	62.2%	61	65.6%	63	67.7%	170	79.8%	521	71.4%
無回答																		
男性	0	0.0%	0	0.0%	0	0.0%	0	0.0%	0	0.0%	0	0.0%	0	0.0%	2	2.0%	2	0.6%
女性	0	0.0%	0	0.0%	0	0.0%	0	0.0%	1	1.4%	0	0.0%	0	0.0%	4	3.5%	5	1.3%
男女合計	0	0.0%	0	0.0%	0	0.0%	0	0.0%	1	0.8%	0	0.0%	0	0.0%	6	2.8%	7	1.0%
全体(人)																		
男性	20		28		29		34		47		50		45		98		351	
女性	14		21		32		34		72		43		48		115		379	
男女合計	34		49		61		68		119		93		93		213		730	

南会津

	10	割合	20	割合	30	割合	40	割合	50	割合	64	割合	69	割合	70～	割合	全体数	割合
1と回答																		
男性	0	0.0%	0	0.0%	1	33.3%	3	33.3%	1	14.3%	1	50.0%	1	16.7%	8	36.4%	15	28.8%
女性	1	50.0%	1	50.0%	0	0.0%	2	33.3%	1	25.0%	0	0.0%	4	57.1%	2	10.0%	11	23.4%
男女合計	1	50.0%	1	20.0%	1	25.0%	5	33.3%	2	18.2%	1	14.3%	5	38.5%	10	23.8%	26	26.3%
2と回答																		
男性	0	0.0%	3	100.0%	2	66.7%	5	55.6%	6	85.7%	1	50.0%	5	83.3%	13	59.1%	35	67.3%
女性	1	50.0%	1	50.0%	1	100.0%	4	66.7%	3	75.0%	5	100.0%	3	42.9%	17	85.0%	35	74.5%
男女合計	1	50.0%	4	80.0%	3	75.0%	9	60.0%	9	81.8%	6	85.7%	8	61.5%	30	71.4%	70	70.7%
無回答																		
男性	0	0.0%	0	0.0%	0	0.0%	1	11.1%	0	0.0%	0	0.0%	0	0.0%	1	4.5%	2	3.8%
女性	0	0.0%	0	0.0%	0	0.0%	0	0.0%	0	0.0%	0	0.0%	0	0.0%	1	5.0%	1	2.1%
男女合計	0	0.0%	0	0.0%	0	0.0%	1	6.7%	0	0.0%	0	0.0%	0	0.0%	2	4.8%	3	3.0%
全体(人)																		
男性	0		3		3		9		7		2		6		22		52	
女性	2		2		1		6		4		5		7		20		47	
男女合計	2		5		4		15		11		7		13		42		99	

相 双

	10	割合	20	割合	30	割合	40	割合	50	割合	64	割合	69	割合	70～	割合	全体数	割合
1と回答																		
男性	0	0.0%	0	0.0%	3	50.0%	2	13.3%	2	22.2%	5	26.3%	6	22.2%	13	16.9%	31	19.4%
女性	0	0.0%	0	0.0%	2	33.3%	8	44.4%	3	17.6%	6	33.3%	6	26.1%	15	23.8%	40	25.2%
男女合計	0	0.0%	0	0.0%	5	41.7%	10	30.3%	5	19.2%	11	29.7%	12	24.0%	28	20.0%	71	22.3%
2と回答																		
男性	5	100.0%	2	100.0%	3	50.0%	13	86.7%	7	77.8%	12	63.2%	21	77.8%	62	80.5%	125	78.1%
女性	8	100.0%	6	100.0%	4	66.7%	10	55.6%	14	82.4%	11	61.1%	17	73.9%	42	66.7%	112	70.4%
男女合計	13	100.0%	8	100.0%	7	58.3%	23	69.7%	21	80.8%	23	62.2%	38	76.0%	104	74.3%	237	74.3%
無回答																		
男性	0	0.0%	0	0.0%	0	0.0%	0	0.0%	0	0.0%	2	10.5%	0	0.0%	2	2.6%	4	2.5%
女性	0	0.0%	0	0.0%	0	0.0%	0	0.0%	0	0.0%	1	5.6%	0	0.0%	6	9.5%	7	4.4%
男女合計	0	0.0%	0	0.0%	0	0.0%	0	0.0%	0	0.0%	3	8.1%	0	0.0%	8	5.7%	11	3.4%
全体(人)																		
男性	5		2		6		15		9		19		27		77		160	
女性	8		6		6		18		17		18		23		63		159	
男女合計	13		8		12		33		26		37		50		140		319	

いわき

	10	割合	20	割合	30	割合	40	割合	50	割合	64	割合	69	割合	70～	割合	全体数	割合
1と回答																		
男性	2	10.5%	5	21.7%	12	23.5%	16	26.7%	9	13.2%	11	31.4%	12	31.6%	29	21.2%	96	22.3%
女性	1	6.7%	8	25.8%	14	31.1%	24	39.3%	24	38.1%	17	41.5%	19	38.8%	51	32.5%	158	34.2%
男女合計	3	8.8%	13	24.1%	26	27.1%	40	33.1%	33	25.2%	28	36.8%	31	35.6%	80	27.2%	254	28.4%
2と回答																		
男性	17	89.5%	18	78.3%	39	76.5%	43	71.7%	59	86.8%	24	68.6%	26	68.4%	105	76.6%	331	76.8%
女性	14	93.3%	23	74.2%	31	68.9%	37	60.7%	39	61.9%	24	58.5%	29	59.2%	99	63.1%	296	64.1%
男女合計	31	91.2%	41	75.9%	70	72.9%	80	66.1%	98	74.8%	48	63.2%	55	63.2%	204	69.4%	627	70.2%
無回答																		
男性	0	0.0%	0	0.0%	0	0.0%	1	1.7%	0	0.0%	0	0.0%	0	0.0%	3	2.2%	4	0.9%
女性	0	0.0%	0	0.0%	0	0.0%	0	0.0%	0	0.0%	0	0.0%	1	2.0%	7	4.5%	8	1.7%
男女合計	0	0.0%	0	0.0%	0	0.0%	1	0.8%	0	0.0%	0	0.0%	1	1.1%	10	3.4%	12	1.3%
全体(人)																		
男性	19		23		51		60		68		35		38		137		431	
女性	15		31		45		61		63		41		49		157		462	
男女合計	34		54		96		121		131		76		87		294		893	

全県 (60歳以上・再掲)

	64	割合	69	割合	70	割合	80	割合	90	割合	全体数	割合
1と回答												
男性	73	27.8%	61	21.4%	97	19.5%	45	16.6%	6	15.8%	282	20.8%
女性	91	35.0%	106	34.6%	131	25.7%	55	17.0%	5	6.0%	388	26.2%
男女合計	164	31.4%	167	28.3%	228	22.7%	100	16.8%	11	9.1%	670	23.6%
2と回答												
男性	188	71.5%	224	78.6%	393	79.1%	218	80.4%	30	78.9%	1053	77.8%
女性	165	63.5%	196	64.1%	360	70.7%	249	77.1%	73	88.0%	1043	70.4%
男女合計	353	67.5%	420	71.1%	753	74.9%	467	78.6%	103	85.1%	2096	73.9%
無回答												
男性	2	0.8%	0	0.0%	7	1.4%	8	3.0%	2	5.3%	19	1.4%
女性	4	1.5%	4	1.3%	18	3.5%	19	5.9%	5	6.0%	50	3.4%
男女合計	6	1.1%	4	0.7%	25	2.5%	27	4.5%	7	5.8%	69	2.4%
全体(人)												
男性	263		285		497		271		38		1354	
女性	260		306		509		323		83		1481	
男女合計	523		591		1006		594		121		2835	

15 飲酒の状況（満20歳以上対象）（調査票 問15）

(1) 飲酒の頻度

問15 あなたは、どのくらいお酒を飲んでいきますか。（あてはまる番号1つに○）

- 1 毎日飲んでいる
- 2 週に5～6回飲んでいる
- 3 週に3～4回飲んでいる
- 4 たまに飲む程度
- 5 以前は飲んでいましたが、今は飲んでいない
- 6 もともと飲まない

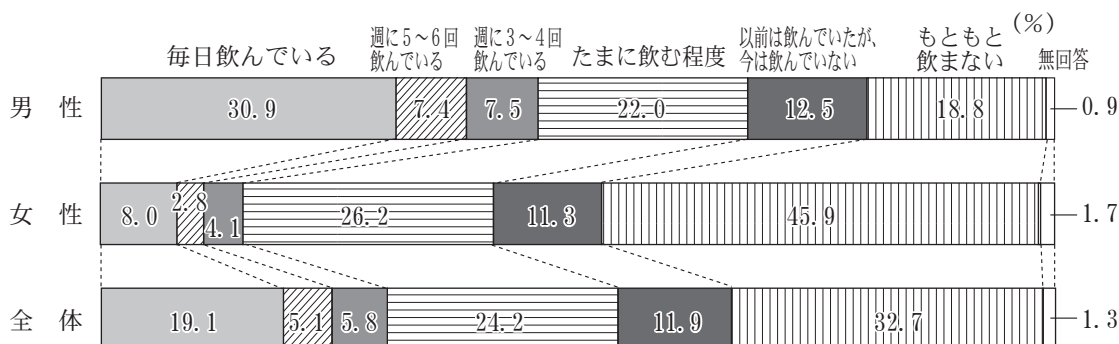

	20	割合	30	割合	40	割合	50	割合	64	割合	69	割合	70	割合	80	割合	90	割合	全体数	割合
1と回答																				
男性	8	4.8%	47	18.7%	95	25.4%	148	37.8%	111	42.2%	108	37.9%	186	37.4%	72	26.6%	8	21.1%	783	30.9%
女性	3	1.7%	18	7.3%	39	11.5%	43	9.8%	35	13.5%	26	8.5%	38	7.5%	11	3.4%	1	1.2%	214	8.0%
男女合計	11	3.2%	65	13.1%	134	18.8%	191	22.9%	146	27.9%	134	22.7%	224	22.3%	83	14.0%	9	7.4%	997	19.1%
2と回答																				
男性	5	3.0%	20	8.0%	31	8.3%	37	9.4%	25	9.5%	35	12.3%	24	4.8%	10	3.7%	1	2.6%	188	7.4%
女性	2	1.1%	5	2.0%	15	4.4%	18	4.1%	9	3.5%	14	4.6%	10	2.0%	3	0.9%	0	0.0%	76	2.8%
男女合計	7	2.0%	25	5.0%	46	6.4%	55	6.6%	34	6.5%	49	8.3%	34	3.4%	13	2.2%	1	0.8%	264	5.1%
3と回答																				
男性	14	8.4%	15	6.0%	30	8.0%	39	9.9%	19	7.2%	23	8.1%	37	7.4%	14	5.2%	0	0.0%	191	7.5%
女性	7	3.9%	14	5.7%	21	6.2%	23	5.2%	12	4.6%	14	4.6%	12	2.4%	7	2.2%	0	0.0%	110	4.1%
男女合計	21	6.1%	29	5.8%	51	7.1%	62	7.4%	31	5.9%	37	6.3%	49	4.9%	21	3.5%	0	0.0%	301	5.8%
4と回答																				
男性	83	50.0%	73	29.1%	106	28.3%	87	22.2%	46	17.5%	40	14.0%	73	14.7%	44	16.2%	6	15.8%	558	22.0%
女性	90	50.3%	82	33.3%	112	32.9%	148	33.6%	78	30.0%	65	21.2%	88	17.3%	41	12.7%	1	1.2%	705	26.2%
男女合計	173	50.1%	155	31.2%	218	30.5%	235	28.2%	124	23.7%	105	17.8%	161	16.0%	85	14.3%	7	5.8%	1263	24.2%
5と回答																				
男性	3	1.8%	13	5.2%	33	8.8%	28	7.1%	33	12.5%	32	11.2%	93	18.7%	65	24.0%	17	44.7%	317	12.5%
女性	22	12.3%	44	17.9%	42	12.4%	55	12.5%	19	7.3%	27	8.8%	56	11.0%	26	8.0%	13	15.7%	304	11.3%
男女合計	25	7.2%	57	11.5%	75	10.5%	83	10.0%	52	9.9%	59	10.0%	149	14.8%	91	15.3%	30	24.8%	621	11.9%
6と回答																				
男性	53	31.9%	83	33.1%	75	20.1%	52	13.3%	26	9.9%	46	16.1%	82	16.5%	55	20.3%	4	10.5%	476	18.8%
女性	54	30.2%	83	33.7%	110	32.4%	154	34.9%	107	41.2%	159	52.0%	290	57.0%	212	65.6%	63	75.9%	1232	45.9%
男女合計	107	31.0%	166	33.4%	185	25.9%	206	24.7%	133	25.4%	205	34.7%	372	37.0%	267	44.9%	67	55.4%	1708	32.7%
無回答																				
男性	0	0.0%	0	0.0%	4	1.1%	1	0.3%	3	1.1%	1	0.4%	2	0.4%	11	4.1%	2	5.3%	24	0.9%
女性	1	0.6%	0	0.0%	1	0.3%	0	0.0%	0	0.0%	1	0.3%	15	2.9%	23	7.1%	5	6.0%	46	1.7%
男女合計	1	0.3%	0	0.0%	5	0.7%	1	0.1%	3	0.6%	2	0.3%	17	1.7%	34	5.7%	7	5.8%	70	1.3%
全体(人)																				
男性	166		251		374		392		263		285		497		271		38		2537	
女性	179		246		340		441		260		306		509		323		83		2687	
男女合計	345		497		714		833		523		591		1006		594		121		5224	

県 北

	20	割合	30	割合	40	割合	50	割合	64	割合	69	割合	70～	割合	全体数	割合
1と回答																
男性	3	6.3%	17	18.5%	33	25.8%	51	43.2%	27	43.5%	21	35.6%	65	34.2%	217	31.1%
女性	1	2.0%	5	5.7%	11	10.7%	14	10.4%	12	19.0%	11	13.4%	10	4.3%	64	8.5%
男女合計	4	4.0%	22	12.2%	44	19.0%	65	25.7%	39	31.2%	32	22.7%	75	17.7%	281	19.4%
2と回答																
男性	1	2.1%	9	9.8%	10	7.8%	10	8.5%	8	12.9%	10	16.9%	9	4.7%	57	8.2%
女性	0	0.0%	0	0.0%	4	3.9%	6	4.4%	1	1.6%	3	3.7%	3	1.3%	17	2.3%
男女合計	1	1.0%	9	5.0%	14	6.1%	16	6.3%	9	7.2%	13	9.2%	12	2.8%	74	5.1%
3と回答																
男性	3	6.3%	3	3.3%	8	6.3%	10	8.5%	3	4.8%	2	3.4%	11	5.8%	40	5.7%
女性	1	2.0%	4	4.5%	6	5.8%	8	5.9%	1	1.6%	8	9.8%	4	1.7%	32	4.2%
男女合計	4	4.0%	7	3.9%	14	6.1%	18	7.1%	4	3.2%	10	7.1%	15	3.5%	72	5.0%
4と回答																
男性	23	47.9%	31	33.7%	45	35.2%	27	22.9%	12	19.4%	13	22.0%	33	17.4%	184	26.4%
女性	27	52.9%	32	36.4%	35	34.0%	44	32.6%	14	22.2%	20	24.4%	27	11.6%	199	26.4%
男女合計	50	50.5%	63	35.0%	80	34.6%	71	28.1%	26	20.8%	33	23.4%	60	14.2%	383	26.4%
5と回答																
男性	1	2.1%	7	7.6%	11	8.6%	7	5.9%	7	11.3%	8	13.6%	41	21.6%	82	11.8%
女性	7	13.7%	17	19.3%	13	12.6%	18	13.3%	6	9.5%	5	6.1%	38	16.3%	104	13.8%
男女合計	8	8.1%	24	13.3%	24	10.4%	25	9.9%	13	10.4%	13	9.2%	79	18.7%	186	12.8%
6と回答																
男性	17	35.4%	25	27.2%	20	15.6%	13	11.0%	4	6.5%	5	8.5%	29	15.3%	113	16.2%
女性	15	29.4%	30	34.1%	34	33.0%	45	33.0%	29	46.0%	35	42.7%	144	61.8%	332	44.0%
男女合計	32	32.3%	55	30.6%	54	23.4%	58	22.9%	33	26.4%	40	28.4%	173	40.9%	445	30.6%
無回答																
男性	0	0.0%	0	0.0%	1	0.8%	0	0.0%	1	1.6%	0	0.0%	2	1.1%	4	0.6%
女性	0	0.0%	0	0.0%	0	0.0%	0	0.0%	0	0.0%	0	0.0%	7	3.0%	7	0.9%
男女合計	0	0.0%	0	0.0%	1	0.4%	0	0.0%	1	0.8%	0	0.0%	9	2.1%	11	0.8%
全体(人)																
男性	48		92		128		118		62		59		190		697	
女性	51		88		103		135		63		82		233		755	
男女合計	99		180		231		253		125		141		423		1452	

県 中

	20	割合	30	割合	40	割合	50	割合	64	割合	69	割合	70～	割合	全体数	割合
1と回答																
男性	1	2.6%	8	16.7%	21	23.1%	40	36.7%	23	36.5%	27	35.1%	57	28.9%	177	28.4%
女性	0	0.0%	2	3.6%	8	8.9%	12	11.5%	5	8.6%	5	7.4%	9	3.9%	41	6.2%
男女合計	1	1.1%	10	9.6%	29	16.0%	52	24.4%	28	23.1%	32	22.1%	66	15.5%	218	17.0%
2と回答																
男性	1	2.6%	2	4.2%	7	7.7%	10	9.2%	3	4.8%	9	11.7%	2	1.0%	34	5.4%
女性	0	0.0%	1	1.8%	5	5.6%	4	3.8%	4	6.9%	4	5.9%	5	2.2%	23	3.5%
男女合計	1	1.1%	3	2.9%	12	6.6%	14	6.6%	7	5.8%	13	9.0%	7	1.6%	57	4.4%
3と回答																
男性	5	12.8%	5	10.4%	9	9.9%	10	9.2%	8	12.7%	8	10.4%	15	7.6%	60	9.6%
女性	1	2.0%	3	5.4%	9	10.0%	3	2.9%	3	5.2%	2	2.9%	4	1.7%	25	3.8%
男女合計	6	6.7%	8	7.7%	18	9.9%	13	6.1%	11	9.1%	10	6.9%	19	4.4%	85	6.6%
4と回答																
男性	19	48.7%	13	27.1%	26	28.6%	28	25.7%	12	19.0%	7	9.1%	28	14.2%	133	21.3%
女性	25	49.0%	18	32.1%	28	31.1%	31	29.8%	23	39.7%	17	25.0%	36	15.7%	178	27.1%
男女合計	44	48.9%	31	29.8%	54	29.8%	59	27.7%	35	28.9%	24	16.6%	64	15.0%	311	24.3%
5と回答																
男性	0	0.0%	2	4.2%	9	9.9%	7	6.4%	9	14.3%	7	9.1%	45	22.8%	79	12.7%
女性	6	11.8%	10	17.9%	10	11.1%	13	12.5%	2	3.4%	5	7.4%	22	9.6%	68	10.4%
男女合計	6	6.7%	12	11.5%	19	10.5%	20	9.4%	11	9.1%	12	8.3%	67	15.7%	147	11.5%
6と回答																
男性	13	33.3%	18	37.5%	19	20.9%	14	12.8%	8	12.7%	19	24.7%	45	22.8%	136	21.8%
女性	18	35.3%	22	39.3%	30	33.3%	41	39.4%	21	36.2%	35	51.5%	143	62.2%	310	47.2%
男女合計	31	34.4%	40	38.5%	49	27.1%	55	25.8%	29	24.0%	54	37.2%	188	44.0%	446	34.8%
無回答																
男性	0	0.0%	0	0.0%	0	0.0%	0	0.0%	0	0.0%	0	0.0%	5	2.5%	5	0.8%
女性	1	2.0%	0	0.0%	0	0.0%	0	0.0%	0	0.0%	0	0.0%	11	4.8%	12	1.8%
男女合計	1	1.1%	0	0.0%	0	0.0%	0	0.0%	0	0.0%	0	0.0%	16	3.7%	17	1.3%
全体(人)																
男性	39		48		91		109		63		77		197		624	
女性	51		56		90		104		58		68		230		657	
男女合計	90		104		181		213		121		145		427		1281	

県 南

	20	割合	30	割合	40	割合	50	割合	64	割合	69	割合	70～	割合	全体数	割合
1と回答																
男性	0	0.0%	4	18.2%	14	37.8%	15	44.1%	13	40.6%	15	45.5%	35	41.2%	96	36.1%
女性	1	5.9%	2	11.1%	2	7.1%	5	10.9%	4	12.5%	2	6.9%	7	7.2%	23	8.6%
男女合計	1	2.5%	6	15.0%	16	24.6%	20	25.0%	17	26.6%	17	27.4%	42	23.1%	119	22.3%
2と回答																
男性	1	4.3%	4	18.2%	3	8.1%	3	8.8%	2	6.3%	1	3.0%	5	5.9%	19	7.1%
女性	0	0.0%	0	0.0%	1	3.6%	4	8.7%	2	6.3%	1	3.4%	1	1.0%	9	3.4%
男女合計	1	2.5%	4	10.0%	4	6.2%	7	8.8%	4	6.3%	2	3.2%	6	3.3%	28	5.3%
3と回答																
男性	3	13.0%	3	13.6%	1	2.7%	4	11.8%	2	6.3%	5	15.2%	4	4.7%	22	8.3%
女性	0	0.0%	0	0.0%	1	3.6%	4	8.7%	3	9.4%	1	3.4%	3	3.1%	12	4.5%
男女合計	3	7.5%	3	7.5%	2	3.1%	8	10.0%	5	7.8%	6	9.7%	7	3.8%	34	6.4%
4と回答																
男性	12	52.2%	6	27.3%	8	21.6%	7	20.6%	5	15.6%	1	3.0%	12	14.1%	51	19.2%
女性	7	41.2%	4	22.2%	11	39.3%	15	32.6%	11	34.4%	9	31.0%	14	14.4%	71	26.6%
男女合計	19	47.5%	10	25.0%	19	29.2%	22	27.5%	16	25.0%	10	16.1%	26	14.3%	122	22.9%
5と回答																
男性	0	0.0%	1	4.5%	4	10.8%	1	2.9%	6	18.8%	3	9.1%	17	20.0%	32	12.0%
女性	4	23.5%	3	16.7%	5	17.9%	7	15.2%	1	3.1%	3	10.3%	8	8.2%	31	11.6%
男女合計	4	10.0%	4	10.0%	9	13.8%	8	10.0%	7	10.9%	6	9.7%	25	13.7%	63	11.8%
6と回答																
男性	7	30.4%	4	18.2%	6	16.2%	3	8.8%	4	12.5%	7	21.2%	11	12.9%	42	15.8%
女性	5	29.4%	9	50.0%	8	28.6%	11	23.9%	11	34.4%	13	44.8%</				

会 津

	20	割合	30	割合	40	割合	50	割合	64	割合	69	割合	70	割合	全体数	割合
1と回答																
男性	3	10.7%	7	24.1%	7	20.6%	16	34.0%	24	48.0%	21	46.7%	33	33.7%	111	33.5%
女性	1	4.8%	2	6.3%	6	17.6%	3	4.2%	7	16.3%	3	6.3%	10	8.7%	32	8.8%
男女合計	4	8.2%	9	14.8%	13	19.1%	19	16.0%	31	33.3%	24	25.8%	43	20.2%	143	20.5%
2と回答																
男性	0	0.0%	1	3.4%	6	17.6%	6	12.8%	4	8.0%	5	11.1%	7	7.1%	29	8.8%
女性	2	9.5%	1	3.1%	3	8.8%	2	2.8%	1	2.3%	2	4.2%	1	0.9%	12	3.3%
男女合計	2	4.1%	2	3.3%	9	13.2%	8	6.7%	5	5.4%	7	7.5%	8	3.8%	41	5.9%
3と回答																
男性	0	0.0%	1	3.4%	3	8.8%	3	6.4%	4	8.0%	5	11.1%	7	7.1%	23	6.9%
女性	1	4.8%	5	15.6%	1	2.9%	3	4.2%	2	4.7%	1	2.1%	2	1.7%	15	4.1%
男女合計	1	2.0%	6	9.8%	4	5.9%	6	5.0%	6	6.5%	6	6.5%	9	4.2%	38	5.5%
4と回答																
男性	14	50.0%	7	24.1%	10	29.4%	13	27.7%	9	18.0%	6	13.3%	12	12.2%	71	21.5%
女性	11	52.4%	12	37.5%	8	23.5%	30	41.7%	13	30.2%	7	14.6%	21	18.3%	102	27.9%
男女合計	25	51.0%	19	31.1%	18	26.5%	43	36.1%	22	23.7%	13	14.0%	33	15.5%	173	24.9%
5と回答																
男性	2	7.1%	1	3.4%	3	8.8%	5	10.6%	3	6.0%	3	6.7%	21	21.4%	38	11.5%
女性	1	4.8%	5	15.6%	3	8.8%	8	11.1%	1	2.3%	2	4.2%	10	8.7%	30	8.2%
男女合計	3	6.1%	6	9.8%	6	8.8%	13	10.9%	4	4.3%	5	5.4%	31	14.6%	68	9.8%
6と回答																
男性	9	32.1%	12	41.4%	5	14.7%	4	8.5%	5	10.0%	5	11.1%	16	16.3%	56	16.9%
女性	5	23.8%	7	21.9%	13	38.2%	26	36.1%	19	44.2%	32	66.7%	64	55.7%	166	45.5%
男女合計	14	28.6%	19	31.1%	18	26.5%	30	25.2%	24	25.8%	37	39.8%	80	37.6%	222	31.9%
無回答																
男性	0	0.0%	0	0.0%	0	0.0%	0	0.0%	1	2.0%	0	0.0%	2	2.0%	3	0.9%
女性	0	0.0%	0	0.0%	0	0.0%	0	0.0%	0	0.0%	1	2.1%	7	6.1%	8	2.2%
男女合計	0	0.0%	0	0.0%	0	0.0%	0	0.0%	1	1.1%	1	1.1%	9	4.2%	11	1.6%
全体(人)																
男性	28		29		34		47		50		45		98		331	
女性	21		32		34		72		43		48		115		365	
男女合計	49		61		68		119		93		93		213		696	

南 会 津

	20	割合	30	割合	40	割合	50	割合	64	割合	69	割合	70～	割合	全体数	割合
1と回答																
男性	0	0.0%	0	0.0%	2	22.2%	3	42.9%	0	0.0%	2	33.3%	9	40.9%	16	30.8%
女性	0	0.0%	0	0.0%	2	33.3%	1	25.0%	0	0.0%	1	14.3%	1	5.0%	5	11.1%
男女合計	0	0.0%	0	0.0%	4	26.7%	4	36.4%	0	0.0%	3	23.1%	10	23.8%	21	21.6%
2と回答																
男性	1	33.3%	1	33.3%	0	0.0%	0	0.0%	1	50.0%	3	50.0%	1	4.5%	7	13.5%
女性	0	0.0%	0	0.0%	0	0.0%	0	0.0%	0	0.0%	0	0.0%	0	0.0%	0	0.0%
男女合計	1	20.0%	1	25.0%	0	0.0%	0	0.0%	1	14.3%	3	23.1%	1	2.4%	7	7.2%
3と回答																
男性	0	0.0%	0	0.0%	0	0.0%	1	14.3%	0	0.0%	0	0.0%	0	0.0%	1	1.9%
女性	0	0.0%	0	0.0%	0	0.0%	0	0.0%	0	0.0%	0	0.0%	1	5.0%	2	4.4%
男女合計	0	0.0%	0	0.0%	0	0.0%	2	18.2%	0	0.0%	0	0.0%	1	2.4%	3	3.1%
4と回答																
男性	2	66.7%	0	0.0%	3	33.3%	0	0.0%	0	0.0%	1	16.7%	0	0.0%	6	11.5%
女性	2	100.0%	1	100.0%	2	33.3%	1	25.0%	1	20.0%	1	14.3%	2	10.0%	10	22.2%
男女合計	4	80.0%	1	25.0%	5	33.3%	1	9.1%	1	14.3%	2	15.4%	2	4.8%	16	16.5%
5と回答																
男性	0	0.0%	1	33.3%	0	0.0%	1	14.3%	1	50.0%	0	0.0%	6	27.3%	9	17.3%
女性	0	0.0%	0	0.0%	0	0.0%	0	0.0%	1	20.0%	4	57.1%	3	15.0%	8	17.8%
男女合計	0	0.0%	1	25.0%	0	0.0%	1	9.1%	2	28.6%	4	30.8%	9	21.4%	17	17.5%
6と回答																
男性	0	0.0%	1	33.3%	3	33.3%	2	28.6%	0	0.0%	0	0.0%	6	27.3%	12	23.1%
女性	0	0.0%	0	0.0%	2	33.3%	1	25.0%	3	60.0%	1	14.3%	12	60.0%	19	42.2%
男女合計	0	0.0%	1	25.0%	5	33.3%	3	27.3%	3	42.9%	1	7.7%	18	42.9%	31	32.0%
無回答																
男性	0	0.0%	0	0.0%	1	11.1%	0	0.0%	0	0.0%	0	0.0%	0	0.0%	1	1.9%
女性	0	0.0%	0	0.0%	0	0.0%	0	0.0%	0	0.0%	0	0.0%	1	5.0%	1	2.2%
男女合計	0	0.0%	0	0.0%	1	6.7%	0	0.0%	0	0.0%	0	0.0%	1	2.4%	2	2.1%
全体(人)																
男性	3		3		9		7		2		6		22		52	
女性	2		1		6		4		5		7		20		45	
男女合計	5		4		15		11		7		13		42		97	

相 双

	20	割合	30	割合	40	割合	50	割合	64	割合	69	割合	70～	割合	全体数	割合
1と回答																
男性	0	0.0%	2	33.3%	7	46.7%	2	22.2%	8	42.1%	10	37.0%	22	28.6%	51	32.9%
女性	0	0.0%	2	33.3%	3	16.7%	2	11.8%	1	5.6%	2	8.7%	1	1.6%	11	7.3%
男女合計	0	0.0%	4	33.3%	10	30.3%	4	15.4%	9	24.3%	12	24.0%	23	16.4%	62	20.3%
2と回答																
男性	0	0.0%	1	16.7%	0	0.0%	2	22.2%	4	21.1%	3	11.1%	6	7.8%	16	10.3%
女性	0	0.0%	0	0.0%	0	0.0%	1	5.9%	0	0.0%	1	4.3%	0	0.0%	2	1.3%
男女合計	0	0.0%	1	8.3%	0	0.0%	3	11.5%	4	10.8%	4	8.0%	6	4.3%	18	5.9%
3と回答																
男性	1	50.0%	1	16.7%	2	13.3%	0	0.0%	1	5.3%	2	7.4%	4	5.2%	11	7.1%
女性	1	16.7%	0	0.0%	1	5.6%	0	0.0%	1	5.6%	0	0.0%	1	1.6%	4	2.6%
男女合計	2	25.0%	1	8.3%	3	9.1%	0	0.0%	2	5.4%	2	4.0%	5	3.6%	15	4.9%
4と回答																
男性	1	50.0%	1	16.7%	3	20.0%	0	0.0%	2	10.5%	6	22.2%	12	15.6%	25	16.1%
女性	1	16.7%	1	16.7%	5	27.8%	3	17.6%	4	22.2%	8	34.8%	5	7.9%	27	17.9%
男女合計	2	25.0%	2	16.7%	8	24.2%	3	11.5%	6	16.2%	14	28.0%	17	12.1%	52	17.0%
5と回答																
男性	0	0.0%	0	0.0%	0	0.0%	3	33.3%	0	0.0%	5	18.5%	19	24.7%	27	17.4%
女性	1	16.7%	1	16.7%	3	16.7%	3	17.6%	3	16.7%	3	13.0%	6	9.5%	20	13.2%
男女合計	1	12.5%	1	8.3%	3	9.1%	6	23.1%	3	8.1%	8	16.0%	25	17.9%	47	15.4%
6と回答																
男性	0	0.0%	1	16.7%	3	20.0%	2	22.2%	3	15.8%	1	3.7%	11	14.3%	21	13.5%
女性	3	50.0%	2	33.3%	6	33.3%	8	47.1%	9	50.0%	9	39.1%	46	73.0%	83	55.0%
男女合計	3	37.5%	3	25.0%	9	27.3%	10	38.5%	12	32.4%	10	20.0%	57	40.7%	104	34.0%

いわき

	20	割合	30	割合	40	割合	50	割合	64	割合	69	割合	70～	割合	全体数	割合
1と回答																
男性	1	4.3%	9	17.6%	11	18.3%	21	30.9%	16	45.7%	12	31.6%	45	32.8%	115	27.9%
女性	0	0.0%	5	11.1%	7	11.5%	6	9.5%	6	14.6%	2	4.1%	12	7.6%	38	8.5%
男女合計	1	1.9%	14	14.6%	18	14.9%	27	20.6%	22	28.9%	14	16.1%	57	19.4%	153	17.8%
2と回答																
男性	1	4.3%	2	3.9%	5	8.3%	6	8.8%	3	8.6%	4	10.5%	5	3.6%	26	6.3%
女性	0	0.0%	3	6.7%	2	3.3%	1	1.6%	1	2.4%	3	6.1%	3	1.9%	13	2.9%
男女合計	1	1.9%	5	5.2%	7	5.8%	7	5.3%	4	5.3%	7	8.0%	8	2.7%	39	4.5%
3と回答																
男性	2	8.7%	2	3.9%	7	11.7%	11	16.2%	1	2.9%	1	2.6%	10	7.3%	34	8.3%
女性	3	9.7%	2	4.4%	3	4.9%	4	6.3%	2	4.9%	2	4.1%	4	2.5%	20	4.5%
男女合計	5	9.3%	4	4.2%	10	8.3%	15	11.5%	3	3.9%	3	3.4%	14	4.8%	54	6.3%
4と回答																
男性	12	52.2%	15	29.4%	11	18.3%	12	17.6%	6	17.1%	6	15.8%	26	19.0%	88	21.4%
女性	17	54.8%	14	31.1%	23	37.7%	24	38.1%	12	29.3%	3	6.1%	25	15.9%	118	26.4%
男女合計	29	53.7%	29	30.2%	34	28.1%	36	27.5%	18	23.7%	9	10.3%	51	17.3%	206	24.0%
5と回答																
男性	0	0.0%	1	2.0%	6	10.0%	4	5.9%	7	20.0%	6	15.8%	26	19.0%	50	12.1%
女性	3	9.7%	8	17.8%	8	13.1%	6	9.5%	5	12.2%	5	10.2%	8	5.1%	43	9.6%
男女合計	3	5.6%	9	9.4%	14	11.6%	10	7.6%	12	15.8%	11	12.6%	34	11.6%	93	10.8%
6と回答																
男性	7	30.4%	22	43.1%	19	31.7%	14	20.6%	2	5.7%	9	23.7%	23	16.8%	96	23.3%
女性	8	25.8%	13	28.9%	17	27.9%	22	34.9%	15	36.6%	34	69.4%	95	60.5%	204	45.6%
男女合計	15	27.8%	35	36.5%	36	29.8%	36	27.5%	17	22.4%	43	49.4%	118	40.1%	300	34.9%
無回答																
男性	0	0.0%	0	0.0%	1	1.7%	0	0.0%	0	0.0%	0	0.0%	2	1.5%	3	0.7%
女性	0	0.0%	0	0.0%	1	1.6%	0	0.0%	0	0.0%	0	0.0%	10	6.4%	11	2.5%
男女合計	0	0.0%	0	0.0%	2	1.7%	0	0.0%	0	0.0%	0	0.0%	12	4.1%	14	1.6%
全体(人)																
男性	23		51		60		68		35		38		137		412	
女性	31		45		61		63		41		49		157		447	
男女合計	54		96		121		131		76		87		294		859	

(2) 飲酒の量 (調査票 問15付問)

付問 問15で1～4を選んだ方におたずねします。あなたが1回に飲む量はどれくらいですか。日本酒にあてはめて計算し、あてはまる番号を1つ選んで○をつけてください。(計算の仕方は、下記のとおりでです。)

1 極少量 2 1合程度 3 2合程度 4 3合以上

焼酎(25度、100ml)は……………日本酒約1合に当たる。
 ビール中瓶1本(500ml)は……………日本酒約1合に当たる。
 ウィスキーダブル1杯(60ml)は ……日本酒約1合に当たる。
 ワイングラス2杯(200ml)は……………日本酒約1合に当たる。
 うすめて飲むときは、もとの量で計算してください。

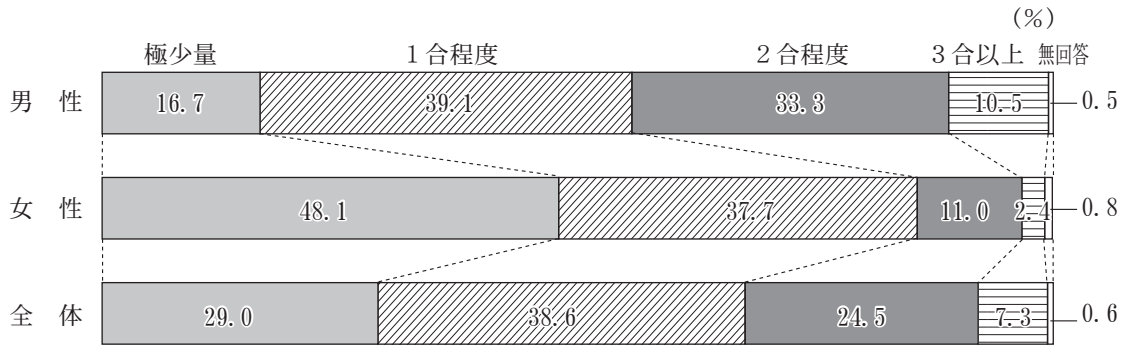

	20	割合	30	割合	40	割合	50	割合	64	割合	69	割合	70	割合	80	割合	90	割合	全体数	割合
1と回答																				
男性	34	30.9%	35	22.6%	41	15.6%	36	11.6%	24	11.9%	30	14.6%	47	14.7%	30	21.4%	10	66.7%	287	16.7%
女性	52	51.0%	62	52.1%	65	34.8%	102	44.0%	64	47.8%	58	48.7%	83	56.1%	44	71.0%	2	100.0%	532	48.1%
男女合計	86	40.6%	97	35.4%	106	23.6%	138	25.4%	88	26.3%	88	27.1%	130	27.8%	74	36.6%	12	70.6%	819	29.0%
2と回答																				
男性	49	44.5%	64	41.3%	106	40.5%	106	34.1%	69	34.3%	73	35.4%	133	41.6%	69	49.3%	4	26.7%	673	39.1%
女性	36	35.3%	41	34.5%	85	45.5%	93	40.1%	48	35.8%	42	35.3%	58	39.2%	14	22.6%	0	0.0%	417	37.7%
男女合計	85	40.1%	105	38.3%	191	42.5%	199	36.6%	117	34.9%	115	35.4%	191	40.8%	83	41.1%	4	23.5%	1090	38.6%
3と回答																				
男性	18	16.4%	45	29.0%	79	30.2%	109	35.0%	87	43.3%	85	41.3%	114	35.6%	34	24.3%	1	6.7%	572	33.3%
女性	9	8.8%	15	12.6%	31	16.6%	27	11.6%	18	13.4%	15	12.6%	5	3.4%	1	1.6%	0	0.0%	121	11.0%
男女合計	27	12.7%	60	21.9%	110	24.5%	136	25.0%	105	31.3%	100	30.8%	119	25.4%	35	17.3%	1	5.9%	693	24.5%
4と回答																				
男性	8	7.3%	11	7.1%	36	13.7%	60	19.3%	21	10.4%	18	8.7%	24	7.5%	2	1.4%	0	0.0%	180	10.5%
女性	4	3.9%	1	0.8%	6	3.2%	7	3.0%	3	2.2%	4	3.4%	1	0.7%	0	0.0%	0	0.0%	26	2.4%
男女合計	12	5.7%	12	4.4%	42	9.4%	67	12.3%	24	7.2%	22	6.8%	25	5.3%	2	1.0%	0	0.0%	206	7.3%
無回答																				
男性	1	0.9%	0	0.0%	0	0.0%	0	0.0%	0	0.0%	0	0.0%	2	0.6%	5	3.6%	0	0.0%	8	0.5%
女性	1	1.0%	0	0.0%	0	0.0%	3	1.3%	1	0.7%	0	0.0%	1	0.7%	3	4.8%	0	0.0%	9	0.8%
男女合計	2	0.9%	0	0.0%	0	0.0%	3	0.6%	1	0.3%	0	0.0%	3	0.6%	8	4.0%	0	0.0%	17	0.6%
全体(人)																				
男性	110		155		262		311		201		206		320		140		15		1720	
女性	102		119		187		232		134		119		148		62		2		1105	
男女合計	212		274		449		543		335		325		468		202		17		2825	

県 北

	20	割合	30	割合	40	割合	50	割合	64	割合	69	割合	70～	割合	全体数	割合
1と回答																
男性	10	33.3%	14	23.3%	23	24.0%	16	16.3%	7	14.0%	10	21.7%	22	18.6%	102	20.5%
女性	13	44.8%	24	58.5%	23	41.1%	34	47.2%	16	57.1%	17	40.5%	29	65.9%	156	50.0%
男女合計	23	39.0%	38	37.6%	46	30.3%	50	29.4%	23	29.5%	27	30.7%	51	31.5%	258	31.9%
2と回答																
男性	13	43.3%	23	38.3%	43	44.8%	27	27.6%	14	28.0%	17	37.0%	46	39.0%	183	36.7%
女性	14	48.3%	12	29.3%	26	46.4%	26	36.1%	6	21.4%	18	42.9%	13	29.5%	115	36.9%
男女合計	27	45.8%	35	34.7%	69	45.4%	53	31.2%	20	25.6%	35	39.8%	59	36.4%	298	36.8%
3と回答																
男性	5	16.7%	18	30.0%	18	18.8%	36	36.7%	25	50.0%	18	39.1%	41	34.7%	161	32.3%
女性	1	3.4%	5	12.2%	5	8.9%	12	16.7%	3	10.7%	6	14.3%	1	2.3%	33	10.6%
男女合計	6	10.2%	23	22.8%	23	15.1%	48	28.2%	28	35.9%	24	27.3%	42	25.9%	194	24.0%
4と回答																
男性	2	6.7%	5	8.3%	12	12.5%	19	19.4%	4	8.0%	1	2.2%	8	6.8%	51	10.2%
女性	1	3.4%	0	0.0%	2	3.6%	0	0.0%	3	10.7%	1	2.4%	0	0.0%	7	2.2%
男女合計	3	5.1%	5	5.0%	14	9.2%	19	11.2%	7	9.0%	2	2.3%	8	4.9%	58	7.2%
無回答																
男性	0	0.0%	0	0.0%	0	0.0%	0	0.0%	0	0.0%	0	0.0%	1	0.8%	1	0.2%
女性	0	0.0%	0	0.0%	0	0.0%	0	0.0%	0	0.0%	0	0.0%	1	2.3%	1	0.3%
男女合計	0	0.0%	0	0.0%	0	0.0%	0	0.0%	0	0.0%	0	0.0%	2	1.2%	2	0.2%
全体(人)																
男性	30		60		96		98		50		46		118		498	
女性	29		41		56		72		28		42		44		312	
男女合計	59		101		152		170		78		88		162		810	

県 中

	20	割合	30	割合	40	割合	50	割合	64	割合	69	割合	70～	割合	全体数	割合
1と回答																
男性	10	38.5%	7	25.0%	6	9.5%	8	9.1%	6	13.0%	5	9.8%	15	14.7%	57	14.1%
女性	12	46.2%	13	54.2%	14	28.0%	17	34.0%	20	57.1%	15	53.6%	32	59.3%	123	46.1%
男女合計	22	42.3%	20	38.5%	20	17.7%	25	18.1%	26	32.1%	20	25.3%	47	30.1%	180	26.8%
2と回答																
男性	9	34.6%	13	46.4%	22	34.9%	37	42.0%	15	32.6%	19	37.3%	52	51.0%	167	41.3%
女性	11	42.3%	8	33.3%	25	50.0%	24	48.0%	11	31.4%	8	28.6%	20	37.0%	107	40.1%
男女合計	20	38.5%	21	40.4%	47	41.6%	61	44.2%	26	32.1%	27	34.2%	72	46.2%	274	40.8%
3と回答																
男性	5	19.2%	5	17.9%	26	41.3%	29	33.0%	19	41.3%	21	41.2%	29	28.4%	134	33.2%
女性	2	7.7%	3	12.5%	10	20.0%	3	6.0%	4	11.4%	4	14.3%	1	1.9%	27	10.1%
男女合計	7	13.5%	8	15.4%	36	31.9%	32	23.2%	23	28.4%	25	31.6%	30	19.2%	161	24.0%
4と回答																
男性	2	7.7%	3	10.7%	9	14.3%	14	15.9%	6	13.0%	6	11.8%	3	2.9%	43	10.6%
女性	1	3.8%	0	0.0%	1	2.0%	3	6.0%	0	0.0%	1	3.6%	0	0.0%	6	2.2%
男女合計	3	5.8%	3	5.8%	10	8.8%	17	12.3%	6	7.4%	7	8.9%	3	1.9%	49	7.3%
無回答																
男性	0	0.0%	0	0.0%	0	0.0%	0	0.0%	0	0.0%	0	0.0%	3	2.9%	3	0.7%
女性	0	0.0%	0	0.0%	0	0.0%	3	6.0%	0	0.0%	0	0.0%	1	1.9%	4	1.5%
男女合計	0	0.0%	0	0.0%	0	0.0%	3	2.2%	0	0.0%	0	0.0%	4	2.6%	7	1.0%
全体(人)																
男性	26		28		63		88		46		51		102		404	
女性	26		24		50		50		35		28		54		267	
男女合計	52		52		113		138		81		79		156		671	

県 南

	20	割合	30	割合	40	割合	50	割合	64	割合	69	割合	70～	割合	全体数	割合
1と回答																
男性	4	25.0%	1	5.9%	1	3.8%	2	6.9%	3	13.6%	3	13.6%	14	25.0%	28	14.9%
女性	5	62.5%	4	66.7%	7	46.7%	12	42.9%	11	55.0%	9	69.2%	15	60.0%	63	54.8%
男女合計	9	37.5%	5	21.7%	8	19.5%	14	24.6%	14	33.3%	12	34.3%	29	35.8%	91	30.0%
2と回答																
男性	7	43.8%	9	52.9%	14	53.8%	9	31.0%	6	27.3%	9	40.9%	21	37.5%	75	39.9%
女性	2	25.0%	2	33.3%	7	46.7%	10	35.7%	6	30.0%	3	23.1%	8	32.0%	38	33.0%
男女合計	9	37.5%	11	47.8%	21	51.2%	19	33.3%	12	28.6%	12	34.3%	29	35.8%	113	37.3%
3と回答																
男性	3	18.8%	7	41.2%	8	30.8%	10	34.5%	11	50.0%	8	36.4%	17	30.4%	64	34.0%
女性	0	0.0%	0	0.0%	1	6.7%	3	10.7%	2	10.0%	1	7.7%	0	0.0%	7	6.1%
男女合計	3	12.5%	7	30.4%	9	22.0%	13	22.8%	13	31.0%	9	25.7%	17	21.0%	71	23.4%
4と回答																
男性	2	12.5%	0	0.0%	3	11.5%	8	27.6%	2	9.1%	2	9.1%	3	5.4%	20	10.6%
女性	1	12.5%	0	0.0%	0	0.0%	3	10.7%	0	0.0%	0	0.0%	1	4.0%	5	4.3%
男女合計	3	12.5%	0	0.0%	3	7.3%	11	19.3%	2	4.8%	2	5.7%	4	4.9%	25	8.3%
無回答																
男性	0	0.0%	0	0.0%	0	0.0%	0	0.0%	0	0.0%	0	0.0%	1	1.8%	1	0.5%
女性	0	0.0%	0	0.0%	0	0.0%	0	0.0%	1	5.0%	0	0.0%	1	4.0%	2	1.7%
男女合計	0	0.0%	0	0.0%	0	0.0%	0	0.0%	1	2.4%	0	0.0%	2	2.5%	3	1.0%
全体(人)																
男性	16		17		26		29		22		22		56		188	
女性	8		6		15		28		20		13		25		115	
男女合計	24		23		41		57		42		35		81		303	

会 津

	20	割合	30	割合	40	割合	50	割合	64	割合	69	割合	70～	割合	全体数	割合
1と回答																
男性	2	11.8%	5	31.3%	5	19.2%	4	10.5%	2	4.9%	3	8.1%	8	13.6%	29	12.4%
女性	8	53.3%	8	40.0%	8	44.4%	18	47.4%	9	39.1%	5	38.5%	22	64.7%	78	48.4%
男女合計	10	31.3%	13	36.1%	13	29.5%	22	28.9%	11	17.2%	8	16.0%	30	32.3%	107	27.1%
2と回答																
男性	12	70.6%	8	50.0%	8	30.8%	14	36.8%	22	53.7%	11	29.7%	25	42.4%	100	42.7%
女性	2	13.3%	10	50.0%	4	22.2%	16	42.1%	11	47.8%	5	38.5%	11	32.4%	59	36.6%
男女合計	14	43.8%	18	50.0%	12	27.3%	30	39.5%	33	51.6%	16	32.0%	36	38.7%	159	40.3%
3と回答																
男性	1	5.9%	3	18.8%	8	30.8%	12	31.6%	14	34.1%	22	59.5%	21	35.6%	81	34.6%
女性	4	26.7%	2	10.0%	5	27.8%	4	10.5%	3	13.0%	2	15.4%	1	2.9%	21	13.0%
男女合計	5	15.6%	5	13.9%	13	29.5%	16	21.1%	17	26.6%	24	48.0%	22	23.7%	102	25.8%
4と回答																
男性	1	5.9%	0	0.0%	5	19.2%	8	21.1%	3	7.3%	1	2.7%	5	8.5%	23	9.8%
女性	1	6.7%	0	0.0%	1	5.6%	0	0.0%	0	0.0%	1	7.7%	0	0.0%	3	1.9%
男女合計	2	6.3%	0	0.0%	6	13.6%	8	10.5%	3	4.7%	2	4.0%	5	5.4%	26	6.6%
無回答																
男性	1	5.9%	0	0.0%	0	0.0%	0	0.0%	0	0.0%	0	0.0%	0	0.0%	1	0.4%
女性	0	0.0%	0	0.0%	0	0.0%	0	0.0%	0	0.0%	0	0.0%	0	0.0%	0	0.0%
男女合計	1	3.1%	0	0.0%	0	0.0%	0	0.0%	0	0.0%	0	0.0%	0	0.0%	1	0.3%
全体(人)																
男性	17		16		26		38		41		37		59		234	
女性	15		20		18		38		23		13		34		161	
男女合計	32		36		44		76		64		50		93		395	

南 会 津

	20	割合	30	割合	40	割合	50	割合	64	割合	69	割合	70～	割合	全体数	割合
1と回答																
男性	1	33.3%	0	0.0%	1	20.0%	0	0.0%	0	0.0%	0	0.0%	1	10.0%	3	10.0%
女性	1	50.0%	0	0.0%	1	25.0%	1	33.3%	0	0.0%	2	100.0%	3	75.0%	8	47.1%
男女合計	2	40.0%	0	0.0%	2	22.2%	1	14.3%	0	0.0%	2	25.0%	4	28.6%	11	23.4%
2と回答																
男性	1	33.3%	0	0.0%	0	0.0%	1	25.0%	1	100.0%	3	50.0%	5	50.0%	11	36.7%
女性	1	50.0%	1	100.0%	1	25.0%	1	33.3%	1	100.0%	0	0.0%	1	25.0%	6	35.3%
男女合計	2	40.0%	1	50.0%	1	11.1%	2	28.6%	2	100.0%	3	37.5%	6	42.9%	17	36.2%
3と回答																
男性	1	33.3%	0	0.0%	3	60.0%	2	50.0%	0	0.0%	2	33.3%	2	20.0%	10	33.3%
女性	0	0.0%	0	0.0%	1	25.0%	1	33.3%	0	0.0%	0	0.0%	0	0.0%	2	11.8%
男女合計	1	20.0%	0	0.0%	4	44.4%	3	42.9%	0	0.0%	2	25.0%	2	14.3%	12	25.5%
4と回答																
男性	0	0.0%	1	100.0%	1	20.0%	1	25.0%	0	0.0%	1	16.7%	2	20.0%	6	20.0%
女性	0	0.0%	0	0.0%	1	25.0%	0	0.0%	0	0.0%	0	0.0%	0	0.0%	1	5.9%
男女合計	0	0.0%	1	50.0%	2	22.2%	1	14.3%	0	0.0%	1	12.5%	2	14.3%	7	14.9%
無回答																
男性	0	0.0%	0	0.0%	0	0.0%	0	0.0%	0	0.0%	0	0.0%	0	0.0%	0	0.0%
女性	0	0.0%	0	0.0%	0	0.0%	0	0.0%	0	0.0%	0	0.0%	0	0.0%	0	0.0%
男女合計	0	0.0%	0	0.0%	0	0.0%	0	0.0%	0	0.0%	0	0.0%	0	0.0%	0	0.0%
全体(人)																
男性	3		1		5		4		1		6		10		30	
女性	2		1		4		3		1		2		4		17	
男女合計	5		2		9		7		2		8		14		47	

相 双

	20	割合	30	割合	40	割合	50	割合	64	割合	69	割合	70～	割合	全体数	割合
1と回答																
男性	1	50.0%	0	0.0%	2	16.7%	0	0.0%	1	6.7%	3	14.3%	9	20.5%	16	15.5%
女性	0	0.0%	1	33.3%	1	11.1%	2	33.3%	1	16.7%	7	63.6%	5	71.4%	17	38.6%
男女合計	1	25.0%	1	12.5%	3	14.3%	2	20.0%	2	9.5%	10	31.3%	14	27.5%	33	22.4%
2と回答																
男性	1	50.0%	2	40.0%	5	41.7%	0	0.0%	7	46.7%	7	33.3%	16	36.4%	38	36.9%
女性	1	50.0%	1	33.3%	5	55.6%	3	50.0%	5	83.3%	4	36.4%	2	28.6%	21	47.7%
男女合計	2	50.0%	3	37.5%	10	47.6%	3	30.0%	12	57.1%	11	34.4%	18	35.3%	59	40.1%
3と回答																
男性	0	0.0%	3	60.0%	5	41.7%	3	75.0%	6	40.0%	8	38.1%	17	38.6%	42	40.8%
女性	1	50.0%	1	33.3%	3	33.3%	1	16.7%	0	0.0%	0	0.0%	0	0.0%	6	13.6%
男女合計	1	25.0%	4	50.0%	8	38.1%	4	40.0%	6	28.6%	8	25.0%	17	33.3%	48	32.7%
4と回答																
男性	0	0.0%	0	0.0%	0	0.0%	1	25.0%	1	6.7%	3	14.3%	1	2.3%	6	5.8%
女性	0	0.0%	0	0.0%	0	0.0%	0	0.0%	0	0.0%	0	0.0%	0	0.0%	0	0.0%
男女合計	0	0.0%	0	0.0%	0	0.0%	1	10.0%	1	4.8%	3	9.4%	1	2.0%	6	4.1%
無回答																
男性	0	0.0%	0	0.0%	0	0.0%	0	0.0%	0	0.0%	0	0.0%	1	2.3%	1	1.0%
女性	0	0.0%	0	0.0%	0	0.0%	0	0.0%	0	0.0%	0	0.0%	0	0.0%	0	0.0%
男女合計	0	0.0%	0	0.0%	0	0.0%	0	0.0%	0	0.0%	0	0.0%	1	2.0%	1	0.7%
全体(人)																
男性	2		5		12		4		15		21		44		103	
女性	2		3		9		6		6		11		7		44	
男女合計	4		8		21		10		21		32		51		147	

いわき

	20	割合	30	割合	40	割合	50	割合	64	割合	69	割合	70～	割合	全体数	割合
1と回答																
男性	6	37.5%	8	28.6%	3	8.8%	6	12.0%	5	19.2%	6	26.1%	18	20.9%	52	19.8%
女性	13	65.0%	12	50.0%	11	31.4%	18	51.4%	7	33.3%	3	30.0%	23	52.3%	87	46.0%
男女合計	19	52.8%	20	38.5%	14	20.3%	24	28.2%	12	25.5%	9	27.3%	41	31.5%	139	30.8%
2と回答																
男性	6	37.5%	9	32.1%	14	41.2%	18	36.0%	4	15.4%	7	30.4%	41	47.7%	99	37.6%
女性	5	25.0%	7	29.2%	17	48.6%	13	37.1%	8	38.1%	4	40.0%	17	38.6%	71	37.6%
男女合計	11	30.6%	16	30.8%	31	44.9%	31	36.5%	12	25.5%	11	33.3%	58	44.6%	170	37.6%
3と回答																
男性	3	18.8%	9	32.1%	11	32.4%	17	34.0%	12	46.2%	6	26.1%	22	25.6%	80	30.4%
女性	1	5.0%	4	16.7%	6	17.1%	3	8.6%	6	28.6%	2	20.0%	3	6.8%	25	13.2%
男女合計	4	11.1%	13	25.0%	17	24.6%	20	23.5%	18	38.3%	8	24.2%	25	19.2%	105	23.2%
4と回答																
男性	1	6.3%	2	7.1%	6	17.6%	9	18.0%	5	19.2%	4	17.4%	4	4.7%	31	11.8%
女性	0	0.0%	1	4.2%	1	2.9%	1	2.9%	0	0.0%	1	10.0%	0	0.0%	4	2.1%
男女合計	1	2.8%	3	5.8%	7	10.1%	10	11.8%	5	10.6%	5	15.2%	4	3.1%	35	7.7%
無回答																
男性	0	0.0%	0	0.0%	0	0.0%	0	0.0%	0	0.0%	0	0.0%	1	1.2%	1	0.4%
女性	1	5.0%	0	0.0%	0	0.0%	0	0.0%	0	0.0%	0	0.0%	1	2.3%	2	1.1%
男女合計	1	2.8%	0	0.0%	0	0.0%	0	0.0%	0	0.0%	0	0.0%	2	1.5%	3	0.7%
全体(人)																
男性	16		28		34		50		26		23		86		263	
女性	20		24		35		35		21		10		44		189	
男女合計	36		52		69		85		47		33		130		452	

(3) 飲酒の状況

(「(1) 飲酒の頻度」及び「(2) 飲酒の量」の回答に関するクロス集計)

	20	割合	30	割合	40	割合	50	割合	64	割合	69	割合	70	割合	80	割合	90	割合	全体数	割合
毎日、極少量お酒を飲んでいる。																				
男性	1	0.6%	4	1.6%	2	0.5%	4	1.0%	3	1.1%	10	3.5%	11	2.2%	10	3.7%	5	13.2%	50	2.0%
女性	1	0.6%	3	1.2%	3	0.9%	8	1.8%	6	2.3%	5	1.6%	9	1.8%	5	1.5%	1	1.2%	41	1.5%
男女合計	2	0.6%	7	1.4%	5	0.7%	12	1.4%	9	1.7%	15	2.5%	20	2.0%	15	2.5%	6	5.0%	91	1.7%
毎日、1合程度お酒を飲んでいる。																				
男性	5	3.0%	13	5.2%	34	9.1%	42	10.7%	29	11.0%	34	11.9%	69	13.9%	36	13.3%	2	5.3%	264	10.4%
女性	1	0.6%	6	2.4%	19	5.6%	20	4.5%	14	5.4%	9	2.9%	25	4.9%	5	1.5%	0	0.0%	99	3.7%
男女合計	6	1.7%	19	3.8%	53	7.4%	62	7.4%	43	8.2%	43	7.3%	94	9.3%	41	6.9%	2	1.7%	363	6.9%
毎日、2合程度お酒を飲んでいる。																				
男性	1	0.6%	23	9.2%	36	9.6%	63	16.1%	62	23.6%	53	18.6%	84	16.9%	25	9.2%	1	2.6%	348	13.7%
女性	1	0.6%	8	3.3%	14	4.1%	13	2.9%	12	4.6%	10	3.3%	4	0.8%	1	0.3%	0	0.0%	63	2.3%
男女合計	2	0.6%	31	6.2%	50	7.0%	76	9.1%	74	14.1%	63	10.7%	88	8.7%	26	4.4%	1	0.8%	411	7.9%
毎日、3合以上お酒を飲んでいる。																				
男性	1	0.6%	7	2.8%	23	6.1%	39	9.9%	17	6.5%	11	3.9%	21	4.2%	1	0.4%	0	0.0%	120	4.7%
女性	0	0.0%	1	0.4%	3	0.9%	2	0.5%	3	1.2%	2	0.7%	0	0.0%	0	0.0%	0	0.0%	11	0.4%
男女合計	1	0.3%	8	1.6%	26	3.6%	41	4.9%	20	3.8%	13	2.2%	21	2.1%	1	0.2%	0	0.0%	131	2.5%
毎日、お酒を飲んでいる。(飲む量未回答)																				
男性	0	0.0%	0	0.0%	0	0.0%	0	0.0%	0	0.0%	0	0.0%	1	0.2%	0	0.0%	0	0.0%	1	0.0%
女性	0	0.0%	0	0.0%	0	0.0%	0	0.0%	0	0.0%	0	0.0%	0	0.0%	0	0.0%	0	0.0%	0	0.0%
男女合計	0	0.0%	0	0.0%	0	0.0%	0	0.0%	0	0.0%	0	0.0%	1	0.1%	0	0.0%	0	0.0%	1	0.0%
週に5～6回、極少量お酒を飲んでいる。																				
男性	0	0.0%	2	0.8%	2	0.5%	1	0.3%	1	0.4%	3	1.1%	0	0.0%	3	1.1%	1	2.6%	13	0.5%
女性	0	0.0%	1	0.4%	0	0.0%	1	0.2%	2	0.8%	5	1.6%	4	0.8%	0	0.0%	0	0.0%	13	0.5%
男女合計	0	0.0%	3	0.6%	2	0.3%	2	0.2%	3	0.6%	8	1.4%	4	0.4%	3	0.5%	1	0.8%	26	0.5%
週に5～6回、1合程度お酒を飲んでいる。																				
男性	3	1.8%	10	4.0%	16	4.3%	14	3.6%	11	4.2%	11	3.9%	13	2.6%	5	1.8%	0	0.0%	83	3.3%
女性	0	0.0%	3	1.2%	10	2.9%	12	2.7%	7	2.7%	8	2.6%	6	1.2%	3	0.9%	0	0.0%	49	1.8%
男女合計	3	0.9%	13	2.6%	26	3.6%	26	3.1%	18	3.4%	19	3.2%	19	1.9%	8	1.3%	0	0.0%	132	2.5%
週に5～6回、2合程度お酒を飲んでいる。																				
男性	2	1.2%	6	2.4%	9	2.4%	17	4.3%	11	4.2%	17	6.0%	8	1.6%	2	0.7%	0	0.0%	72	2.8%
女性	2	1.1%	1	0.4%	3	0.9%	2	0.5%	0	0.0%	1	0.3%	0	0.0%	0	0.0%	0	0.0%	9	0.3%
男女合計	4	1.2%	7	1.4%	12	1.7%	19	2.3%	11	2.1%	18	3.0%	8	0.8%	2	0.3%	0	0.0%	81	1.6%
週に5～6回、3合以上お酒を飲んでいる。																				
男性	0	0.0%	2	0.8%	4	1.1%	5	1.3%	2	0.8%	4	1.4%	3	0.6%	0	0.0%	0	0.0%	20	0.8%
女性	0	0.0%	0	0.0%	2	0.6%	3	0.7%	0	0.0%	0	0.0%	0	0.0%	0	0.0%	0	0.0%	5	0.2%
男女合計	0	0.0%	2	0.4%	6	0.8%	8	1.0%	2	0.4%	4	0.7%	3	0.3%	0	0.0%	0	0.0%	25	0.5%

	20	割合	30	割合	40	割合	50	割合	64	割合	69	割合	70	割合	80	割合	90	割合	全体数	割合		
週に5～6回、お酒を飲んでいる。(飲む量未回答)																						
男性	0	0.0%	0	0.0%	0	0.0%	0	0.0%	0	0.0%	0	0.0%	0	0.0%	0	0.0%	0	0.0%	0	0.0%		
女性	0	0.0%	0	0.0%	0	0.0%	0	0.0%	0	0.0%	0	0.0%	0	0.0%	0	0.0%	0	0.0%	0	0.0%		
男女合計	0	0.0%	0	0.0%	0	0.0%	0	0.0%	0	0.0%	0	0.0%	0	0.0%	0	0.0%	0	0.0%	0	0.0%		
週に3～4回、極少量お酒を飲んでいる。																						
男性	0	0.0%	2	0.8%	5	1.3%	1	0.3%	2	0.8%	2	0.7%	7	1.4%	1	0.4%	0	0.0%	20	0.8%		
女性	1	0.6%	5	2.0%	2	0.6%	8	1.8%	7	2.7%	3	1.0%	4	0.8%	4	1.2%	0	0.0%	34	1.3%		
男女合計	1	0.3%	7	1.4%	7	1.0%	9	1.1%	9	1.7%	5	0.8%	11	1.1%	5	0.8%	0	0.0%	54	1.0%		
週に3～4回、1合程度お酒を飲んでいる。																						
男性	4	2.4%	7	2.8%	10	2.7%	18	4.6%	9	3.4%	7	2.5%	17	3.4%	5	1.8%	0	0.0%	77	3.0%		
女性	3	1.7%	7	2.8%	16	4.7%	9	2.0%	3	1.2%	8	2.6%	7	1.4%	2	0.6%	0	0.0%	55	2.0%		
男女合計	7	2.0%	14	2.8%	26	3.6%	27	3.2%	12	2.3%	15	2.5%	24	2.4%	7	1.2%	0	0.0%	132	2.5%		
週に3～4回、2合程度お酒を飲んでいる。																						
男性	6	3.6%	6	2.4%	12	3.2%	14	3.6%	8	3.0%	11	3.9%	13	2.6%	5	1.8%	0	0.0%	75	3.0%		
女性	1	0.6%	2	0.8%	3	0.9%	6	1.4%	2	0.8%	3	1.0%	1	0.2%	0	0.0%	0	0.0%	18	0.7%		
男女合計	7	2.0%	8	1.6%	15	2.1%	20	2.4%	10	1.9%	14	2.4%	14	1.4%	5	0.8%	0	0.0%	93	1.8%		
週に3～4回、3合以上お酒を飲んでいる。																						
男性	4	2.4%	0	0.0%	3	0.8%	6	1.5%	0	0.0%	3	1.1%	0	0.0%	1	0.4%	0	0.0%	17	0.7%		
女性	1	0.6%	0	0.0%	0	0.0%	0	0.0%	0	0.0%	0	0.0%	0	0.0%	0	0.0%	0	0.0%	1	0.0%		
男女合計	5	1.4%	0	0.0%	3	0.4%	6	0.7%	0	0.0%	3	0.5%	0	0.0%	1	0.2%	0	0.0%	18	0.3%		
週に3～4回、お酒を飲んでいる。(飲む量未回答)																						
男性	0	0.0%	0	0.0%	0	0.0%	0	0.0%	0	0.0%	0	0.0%	0	0.0%	2	0.7%	0	0.0%	2	0.1%		
女性	1	0.6%	0	0.0%	0	0.0%	0	0.0%	0	0.0%	0	0.0%	0	0.0%	1	0.3%	0	0.0%	2	0.1%		
男女合計	1	0.3%	0	0.0%	0	0.0%	0	0.0%	0	0.0%	0	0.0%	0	0.0%	3	0.5%	0	0.0%	4	0.1%		
たまに、極少量お酒を飲んでいる。																						
男性	33	19.9%	27	10.8%	32	8.6%	30	7.7%	18	6.8%	15	5.3%	29	5.8%	16	5.9%	4	10.5%	204	8.0%		
女性	50	27.9%	53	21.5%	60	17.6%	85	19.3%	49	18.8%	45	14.7%	66	13.0%	35	10.8%	1	1.2%	444	16.5%		
男女合計	83	24.1%	80	16.1%	92	12.9%	115	13.8%	67	12.8%	60	10.2%	95	9.4%	51	8.6%	5	4.1%	648	12.4%		
たまに、1合程度お酒を飲んでいる。																						
男性	37	22.3%	34	13.5%	46	12.3%	32	8.2%	20	7.6%	21	7.4%	34	6.8%	23	8.5%	2	5.3%	249	9.8%		
女性	32	17.9%	25	10.2%	40	11.8%	52	11.8%	24	9.2%	17	5.6%	20	3.9%	4	1.2%	0	0.0%	214	8.0%		
男女合計	69	20.0%	59	11.9%	86	12.0%	84	10.1%	44	8.4%	38	6.4%	54	5.4%	27	4.5%	2	1.7%	463	8.9%		
たまに、2合程度お酒を飲んでいる。																						
男性	9	5.4%	10	4.0%	22	5.9%	15	3.8%	6	2.3%	4	1.4%	9	1.8%	2	0.7%	0	0.0%	77	3.0%		
女性	5	2.8%	4	1.6%	11	3.2%	6	1.4%	4	1.5%	1	0.3%	0	0.0%	0	0.0%	0	0.0%	31	1.2%		
男女合計	14	4.1%	14	2.8%	33	4.6%	21	2.5%	10	1.9%	5	0.8%	9	0.9%	2	0.3%	0	0.0%	108	2.1%		
たまに、3合以上お酒を飲んでいる。																						
男性	3	1.8%	2	0.8%	6	1.6%	10	2.6%	2	0.8%	0	0.0%	0	0.0%	0	0.0%	0	0.0%	23	0.9%		
女性	3	1.7%	0	0.0%	1	0.3%	2	0.5%	0	0.0%	2	0.7%	1	0.2%	0	0.0%	0	0.0%	9	0.3%		
男女合計	6	1.7%	2	0.4%	7	1.0%	12	1.4%	2	0.4%	2	0.3%	1	0.1%	0	0.0%	0	0.0%	32	0.6%		
たまに、お酒を飲んでいる。(飲む量未回答)																						
男性	1	0.6%	0	0.0%	0	0.0%	0	0.0%	0	0.0%	0	0.0%	1	0.2%	3	1.1%	0	0.0%	5	0.2%		
女性	0	0.0%	0	0.0%	0	0.0%	3	0.7%	1	0.4%	0	0.0%	1	0.2%	2	0.6%	0	0.0%	7	0.3%		
男女合計	1	0.3%	0	0.0%	0	0.0%	3	0.4%	1	0.2%	0	0.0%	2	0.2%	5	0.8%	0	0.0%	12	0.2%		
*参考 以前は飲んでいたが、今は飲んでいない。																						
男性	3	1.8%	13	5.2%	33	8.8%	28	7.1%	33	12.5%	32	11.2%	93	18.7%	65	24.0%	17	44.7%	317	12.5%		
女性	22	12.3%	44	17.9%	42	12.4%	55	12.5%	19	7.3%	27	8.8%	56	11.0%	26	8.0%	13	15.7%	304	11.3%		
男女合計	25	7.2%	57	11.5%	75	10.5%	83	10.0%	52	9.9%	59	10.0%	149	14.8%	91	15.3%	30	24.8%	621	11.9%		
*参考 もともと飲まない。																						
男性	53	31.9%	83	33.1%	75	20.1%	52	13.3%	26	9.9%	46	16.1%	82	16.5%	55	20.3%	4	10.5%	476	18.8%		
女性	54	30.2%	83	33.7%	110	32.4%	154	34.9%	107	41.2%	159	52.0%	290	57.0%	212	65.6%	63	75.9%	1232	45.9%		
男女合計	107	31.0%	166	33.4%	185	25.9%	206	24.7%	133	25.4%	205	34.7%	372	37.0%	267	44.9%	67	55.4%	1708	32.7%		
無回答																						
男性	0	0.0%	0	0.0%	4	1.1%	1	0.3%	3	1.1%	1	0.4%	2	0.4%	11	4.1%	2	5.3%	24	0.9%		
女性	1	0.6%	0	0.0%	1	0.3%	0	0.0%	0	0.0%	1	0.3%	15	2.9%	23	7.1%	5	6.0%	46	1.7%		
男女合計	1	0.3%	0	0.0%	5	0.7%	1	0.1%	3	0.6%	2	0.3%	17	1.7%	34	5.7%	7	5.8%	70	1.3%		
全体(人)																						
男性	166		251		374		392		263		285		497		271		38		2537			
女性	179		246		340		441		260		306		509		323		83		2687			
男女合計	345		497		714		833		523		591		1006		594		121		5224			

16 定期的な歯科健診の状況（調査票 問16）

問16 あなたは定期的に歯科健診（歯石の除去、歯面清掃を含む）を受けていますか。

1 はい 2 いいえ

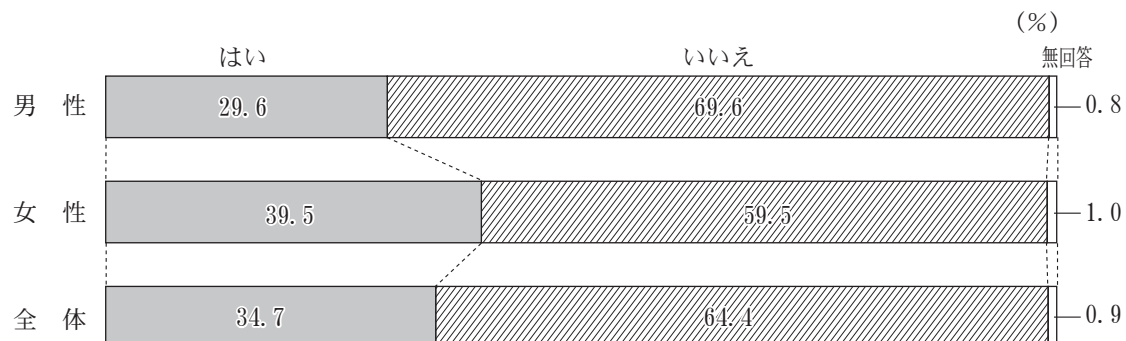

	10	割合	20	割合	30	割合	40	割合	50	割合	64	割合	69	割合	70	割合	80	割合	90	割合	全体数	割合
1と回答																						
男性	39	32.8%	36	21.7%	61	24.3%	99	26.5%	117	29.8%	88	33.5%	107	37.5%	158	31.8%	74	27.3%	7	18.4%	786	29.6%
女性	46	37.1%	59	33.0%	107	43.5%	158	46.5%	176	39.9%	111	42.7%	128	41.8%	211	41.5%	101	31.3%	13	15.7%	1110	39.5%
男女合計	85	35.0%	95	27.5%	168	33.8%	257	36.0%	293	35.2%	199	38.0%	235	39.8%	369	36.7%	175	29.5%	20	16.5%	1896	34.7%
2と回答																						
男性	80	67.2%	129	77.7%	190	75.7%	272	72.7%	275	70.2%	174	66.2%	178	62.5%	332	66.8%	190	70.1%	29	76.3%	1849	69.6%
女性	78	62.9%	120	67.0%	139	56.5%	182	53.5%	265	60.1%	148	56.9%	177	57.8%	289	56.8%	209	64.7%	66	79.5%	1673	59.5%
男女合計	158	65.0%	249	72.2%	329	66.2%	454	63.6%	540	64.8%	322	61.6%	355	60.1%	621	61.7%	399	67.2%	95	78.5%	3522	64.4%
無回答																						
男性	0	0.0%	1	0.6%	0	0.0%	3	0.8%	0	0.0%	1	0.4%	0	0.0%	7	1.4%	7	2.6%	2	5.3%	21	0.8%
女性	0	0.0%	0	0.0%	0	0.0%	0	0.0%	0	0.0%	1	0.4%	1	0.3%	9	1.8%	13	4.0%	4	4.8%	28	1.0%
男女合計	0	0.0%	1	0.3%	0	0.0%	3	0.4%	0	0.0%	2	0.4%	1	0.2%	16	1.6%	20	3.4%	6	5.0%	49	0.9%
全体(人)																						
男性	119		166		251		374		392		263		285		497		271		38		2656	
女性	124		179		246		340		441		260		306		509		323		83		2811	
男女合計	243		345		497		714		833		523		591		1006		594		121		5467	

県 北

	10	割合	20	割合	30	割合	40	割合	50	割合	64	割合	69	割合	70～	割合	全体数	割合
1と回答																		
男性	10	28.6%	13	27.1%	19	20.7%	28	21.9%	42	35.6%	24	38.7%	17	28.8%	53	27.9%	206	28.1%
女性	14	37.8%	18	35.3%	38	43.2%	44	42.7%	59	43.7%	25	39.7%	34	41.5%	78	33.5%	310	39.1%
男女合計	24	33.3%	31	31.3%	57	31.7%	72	31.2%	101	39.9%	49	39.2%	51	36.2%	131	31.0%	516	33.9%
2と回答																		
男性	25	71.4%	35	72.9%	73	79.3%	98	76.6%	76	64.4%	38	61.3%	42	71.2%	134	70.5%	521	71.2%
女性	23	62.2%	33	64.7%	50	56.8%	59	57.3%	76	56.3%	38	60.3%	48	58.5%	150	64.4%	477	60.2%
男女合計	48	66.7%	68	68.7%	123	68.3%	157	68.0%	152	60.1%	76	60.8%	90	63.8%	284	67.1%	998	65.5%
無回答																		
男性	0	0.0%	0	0.0%	0	0.0%	2	1.6%	0	0.0%	0	0.0%	0	0.0%	3	1.6%	5	0.7%
女性	0	0.0%	0	0.0%	0	0.0%	0	0.0%	0	0.0%	0	0.0%	0	0.0%	5	2.1%	5	0.6%
男女合計	0	0.0%	0	0.0%	0	0.0%	2	0.9%	0	0.0%	0	0.0%	0	0.0%	8	1.9%	10	0.7%
全体(人)																		
男性	35		48		92		128		118		62		59		190		732	
女性	37		51		88		103		135		63		82		233		792	
男女合計	72		99		180		231		253		125		141		423		1524	

県 中

	10	割合	20	割合	30	割合	40	割合	50	割合	64	割合	69	割合	70～	割合	全体数	割合
1と回答																		
男性	10	30.3%	4	10.3%	10	20.8%	27	29.7%	29	26.6%	19	30.2%	32	41.6%	50	25.4%	181	27.5%
女性	11	37.9%	18	35.3%	23	41.1%	36	40.0%	37	35.6%	23	39.7%	23	33.8%	83	36.1%	254	37.0%
男女合計	21	33.9%	22	24.4%	33	31.7%	63	34.8%	66	31.0%	42	34.7%	55	37.9%	133	31.1%	435	32.4%
2と回答																		
男性	23	69.7%	35	89.7%	38	79.2%	64	70.3%	80	73.4%	44	69.8%	45	58.4%	144	73.1%	473	72.0%
女性	18	62.1%	33	64.7%	33	58.9%	54	60.0%	67	64.4%	35	60.3%	45	66.2%	140	60.9%	425	62.0%
男女合計	41	66.1%	68	75.6%	71	68.3%	118	65.2%	147	69.0%	79	65.3%	90	62.1%	284	66.5%	898	66.9%
無回答																		
男性	0	0.0%	0	0.0%	0	0.0%	0	0.0%	0	0.0%	0	0.0%	0	0.0%	3	1.5%	3	0.5%
女性	0	0.0%	0	0.0%	0	0.0%	0	0.0%	0	0.0%	0	0.0%	0	0.0%	7	3.0%	7	1.0%
男女合計	0	0.0%	0	0.0%	0	0.0%	0	0.0%	0	0.0%	0	0.0%	0	0.0%	10	2.3%	10	0.7%
全体(人)																		
男性	33		39		48		91		109		63		77		197		657	
女性	29		51		56		90		104		58		68		230		686	
男女合計	62		90		104		181		213		121		145		427		1343	

県 南

	10	割合	20	割合	30	割合	40	割合	50	割合	64	割合	69	割合	70～	割合	全体数	割合
1と回答																		
男性	1	14.3%	4	17.4%	9	40.9%	7	18.9%	7	20.6%	16	50.0%	17	51.5%	19	22.4%	80	29.3%
女性	4	21.1%	3	17.6%	9	50.0%	17	60.7%	18	39.1%	11	34.4%	12	41.4%	33	34.0%	107	37.4%
男女合計	5	19.2%	7	17.5%	18	45.0%	24	36.9%	25	31.3%	27	42.2%	29	46.8%	52	28.6%	187	33.5%
2と回答																		
男性	6	85.7%	19	82.6%	13	59.1%	30	81.1%	27	79.4%	16	50.0%	16	48.5%	63	74.1%	190	69.6%
女性	15	78.9%	14	82.4%	9	50.0%	11	39.3%	28	60.9%	20	62.5%	17	58.6%	60	61.9%	174	60.8%
男女合計	21	80.8%	33	82.5%	22	55.0%	41	63.1%	55	68.8%	36	56.3%	33	53.2%	123	67.6%	364	65.1%
無回答																		
男性	0	0.0%	0	0.0%	0	0.0%	0	0.0%	0	0.0%	0	0.0%	0	0.0%	3	3.5%	3	1.1%
女性	0	0.0%	0	0.0%	0	0.0%	0	0.0%	0	0.0%	1	3.1%	0	0.0%	4	4.1%	5	1.7%
男女合計	0	0.0%	0	0.0%	0	0.0%	0	0.0%	0	0.0%	1	1.6%	0	0.0%	7	3.8%	8	1.4%
全体(人)																		
男性	7		23		22		37		34		32		33		85		273	
女性	19		17		18		28		46		32		29		97		286	
男女合計	26		40		40		65		80		64		62		182		559	

会 津

	10	割合	20	割合	30	割合	40	割合	50	割合	64	割合	69	割合	70～	割合	全体数	割合
1と回答																		
男性	9	45.0%	5	17.9%	6	20.7%	11	32.4%	9	19.1%	16	32.0%	10	22.2%	28	28.6%	94	26.8%
女性	5	35.7%	7	33.3%	13	40.6%	17	50.0%	21	29.2%	22	51.2%	19	39.6%	32	27.8%	136	35.9%
男女合計	14	41.2%	12	24.5%	19	31.1%	28	41.2%	30	25.2%	38	40.9%	29	31.2%	60	28.2%	230	31.5%
2と回答																		
男性	11	55.0%	22	78.6%	23	79.3%	23	67.6%	38	80.9%	34	68.0%	35	77.8%	68	69.4%	254	72.4%
女性	9	64.3%	14	66.7%	19	59.4%	17	50.0%	51	70.8%	21	48.8%	29	60.4%	80	69.6%	240	63.3%
男女合計	20	58.8%	36	73.5%	42	68.9%	40	58.8%	89	74.8%	55	59.1%	64	68.8%	148	69.5%	494	67.7%
無回答																		
男性	0	0.0%	1	3.6%	0	0.0%	0	0.0%	0	0.0%	0	0.0%	0	0.0%	2	2.0%	3	0.9%
女性	0	0.0%	0	0.0%	0	0.0%	0	0.0%	0	0.0%	0	0.0%	0	0.0%	3	2.6%	3	0.8%
男女合計	0	0.0%	1	2.0%	0	0.0%	0	0.0%	0	0.0%	0	0.0%	0	0.0%	5	2.3%	6	0.8%
全体(人)																		
男性	20		28		29		34		47		50		45		98		351	
女性	14		21		32		34		72		43		48		115		379	
男女合計	34		49		61		68		119		93		93		213		730	

南 会 津

	10	割合	20	割合	30	割合	40	割合	50	割合	64	割合	69	割合	70～	割合	全体数	割合
1と回答																		
男性	0	0.0%	1	33.3%	1	33.3%	3	33.3%	3	42.9%	0	0.0%	1	16.7%	5	22.7%	14	26.9%
女性	2	100.0%	0	0.0%	0	0.0%	3	50.0%	1	25.0%	2	40.0%	4	57.1%	8	40.0%	20	42.6%
男女合計	2	100.0%	1	20.0%	1	25.0%	6	40.0%	4	36.4%	2	28.6%	5	38.5%	13	31.0%	34	34.3%
2と回答																		
男性	0	0.0%	2	66.7%	2	66.7%	5	55.6%	4	57.1%	2	100.0%	5	83.3%	16	72.7%	36	69.2%
女性	0	0.0%	2	100.0%	1	100.0%	3	50.0%	3	75.0%	3	60.0%	3	42.9%	11	55.0%	26	55.3%
男女合計	0	0.0%	4	80.0%	3	75.0%	8	53.3%	7	63.6%	5	71.4%	8	61.5%	27	64.3%	62	62.6%
無回答																		
男性	0	0.0%	0	0.0%	0	0.0%	1	11.1%	0	0.0%	0	0.0%	0	0.0%	1	4.5%	2	3.8%
女性	0	0.0%	0	0.0%	0	0.0%	0	0.0%	0	0.0%	0	0.0%	0	0.0%	1	5.0%	1	2.1%
男女合計	0	0.0%	0	0.0%	0	0.0%	1	6.7%	0	0.0%	0	0.0%	0	0.0%	2	4.8%	3	3.0%
全体(人)																		
男性	0		3		3		9		7		2		6		22		52	
女性	2		2		1		6		4		5		7		20		47	
男女合計	2		5		4		15		11		7		13		42		99	

相 双

	10	割合	20	割合	30	割合	40	割合	50	割合	64	割合	69	割合	70～	割合	全体数	割合
1と回答																		
男性	2	40.0%	1	50.0%	3	50.0%	3	20.0%	3	33.3%	4	21.1%	15	55.6%	27	35.1%	58	36.3%
女性	5	62.5%	2	33.3%	4	66.7%	9	50.0%	8	47.1%	10	55.6%	15	65.2%	28	44.4%	81	50.9%
男女合計	7	53.8%	3	37.5%	7	58.3%	12	36.4%	11	42.3%	14	37.8%	30	60.0%	55	39.3%	139	43.6%
2と回答																		
男性	3	60.0%	1	50.0%	3	50.0%	12	80.0%	6	66.7%	14	73.7%	12	44.4%	48	62.3%	99	61.9%
女性	3	37.5%	4	66.7%	2	33.3%	9	50.0%	9	52.9%	8	44.4%	7	30.4%	34	54.0%	76	47.8%
男女合計	6	46.2%	5	62.5%	5	41.7%	21	63.6%	15	57.7%	22	59.5%	19	38.0%	82	58.6%	175	54.9%
無回答																		
男性	0	0.0%	0	0.0%	0	0.0%	0	0.0%	0	0.0%	1	5.3%	0	0.0%	2	2.6%	3	1.9%
女性	0	0.0%	0	0.0%	0	0.0%	0	0.0%	0	0.0%	0	0.0%	1	4.3%	1	1.6%	2	1.3%
男女合計	0	0.0%	0	0.0%	0	0.0%	0	0.0%	0	0.0%	1	2.7%	1	2.0%	3	2.1%	5	1.6%
全体(人)																		
男性	5		2		6		15		9		19		27		77		160	
女性	8		6		6		18		17		18		23		63		159	
男女合計	13		8		12		33		26		37		50		140		319	

いわき

	10	割合	20	割合	30	割合	40	割合	50	割合	64	割合	69	割合	70～	割合	全体数	割合
1と回答																		
男性	7	36.8%	8	34.8%	13	25.5%	20	33.3%	24	35.3%	9	25.7%	15	39.5%	57	41.6%	153	35.5%
女性	5	33.3%	11	35.5%	20	44.4%	32	52.5%	32	50.8%	18	43.9%	21	42.9%	63	40.1%	202	43.7%
男女合計	12	35.3%	19	35.2%	33	34.4%	52	43.0%	56	42.7%	27	35.5%	36	41.4%	120	40.8%	355	39.8%
2と回答																		
男性	12	63.2%	15	65.2%	38	74.5%	40	66.7%	44	64.7%	26	74.3%	23	60.5%	78	56.9%	276	64.0%
女性	10	66.7%	20	64.5%	25	55.6%	29	47.5%	31	49.2%	23	56.1%	28	57.1%	89	56.7%	255	55.2%
男女合計	22	64.7%	35	64.8%	63	65.6%	69	57.0%	75	57.3%	49	64.5%	51	58.6%	167	56.8%	531	59.5%
無回答																		
男性	0	0.0%	0	0.0%	0	0.0%	0	0.0%	0	0.0%	0	0.0%	0	0.0%	2	1.5%	2	0.5%
女性	0	0.0%	0	0.0%	0	0.0%	0	0.0%	0	0.0%	0	0.0%	0	0.0%	5	3.2%	5	1.1%
男女合計	0	0.0%	0	0.0%	0	0.0%	0	0.0%	0	0.0%	0	0.0%	0	0.0%	7	2.4%	7	0.8%
全体(人)																		
男性	19		23		51		60		68		35		38		137		431	
女性	15		31		45		61		63		41		49		157		462	
男女合計	34		54		96		121		131		76		87		294		893	

全県 (60歳以上・再掲)

	64	割合	69	割合	70	割合	80	割合	90	割合	全体数	割合
1と回答												
男性	88	33.5%	107	37.5%	158	31.8%	74	27.3%	7	18.4%	434	32.1%
女性	111	42.7%	128	41.8%	211	41.5%	101	31.3%	13	15.7%	564	38.1%
男女合計	199	38.0%	235	39.8%	369	36.7%	175	29.5%	20	16.5%	998	35.2%
2と回答												
男性	174	66.2%	178	62.5%	332	66.8%	190	70.1%	29	76.3%	903	66.7%
女性	148	56.9%	177	57.8%	289	56.8%	209	64.7%	66	79.5%	889	60.0%
男女合計	322	61.6%	355	60.1%	621	61.7%	399	67.2%	95	78.5%	1792	63.2%
無回答												
男性	1	0.4%	0	0.0%	7	1.4%	7	2.6%	2	5.3%	17	1.3%
女性	1	0.4%	1	0.3%	9	1.8%	13	4.0%	4	4.8%	28	1.9%
男女合計	2	0.4%	1	0.2%	16	1.6%	20	3.4%	6	5.0%	45	1.6%
全体(人)												
男性	263		285		497		271		38		1354	
女性	260		306		509		323		83		1481	
男女合計	523		591		1006		594		121		2835	

17 歯みがきの状況（調査票 問17）

問17 あなたは、毎食後（1日3回以上）歯をみがいていますか。

1 はい 2 いいえ

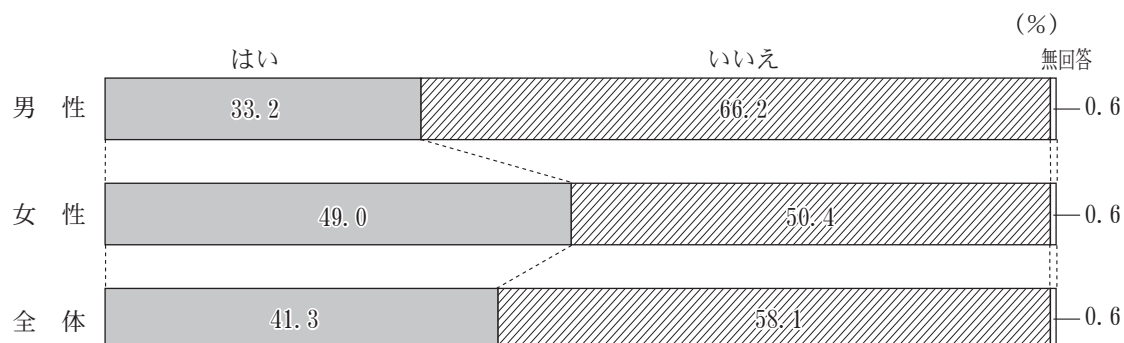

	10	割合	20	割合	30	割合	40	割合	50	割合	64	割合	69	割合	70	割合	80	割合	90	割合	全体数	割合
1と回答																						
男性	40	33.6%	58	34.9%	86	34.3%	109	29.1%	107	27.3%	82	31.2%	102	35.8%	192	38.6%	96	35.4%	10	26.3%	882	33.2%
女性	56	45.2%	107	59.8%	116	47.2%	178	52.4%	199	45.1%	127	48.8%	154	50.3%	260	51.1%	148	45.8%	33	39.8%	1378	49.0%
男女合計	96	39.5%	165	47.8%	202	40.6%	287	40.2%	306	36.7%	209	40.0%	256	43.3%	452	44.9%	244	41.1%	43	35.5%	2260	41.3%
2と回答																						
男性	79	66.4%	108	65.1%	165	65.7%	263	70.3%	284	72.4%	180	68.4%	183	64.2%	302	60.8%	167	61.6%	28	73.7%	1759	66.2%
女性	68	54.8%	72	40.2%	130	52.8%	162	47.6%	241	54.6%	133	51.2%	150	49.0%	244	47.9%	167	51.7%	49	59.0%	1416	50.4%
男女合計	147	60.5%	180	52.2%	295	59.4%	425	59.5%	525	63.0%	313	59.8%	333	56.3%	546	54.3%	334	56.2%	77	63.6%	3175	58.1%
無回答																						
男性	0	0.0%	0	0.0%	0	0.0%	2	0.5%	1	0.3%	1	0.4%	0	0.0%	3	0.6%	8	3.0%	0	0.0%	15	0.6%
女性	0	0.0%	0	0.0%	0	0.0%	0	0.0%	1	0.2%	0	0.0%	2	0.7%	5	1.0%	8	2.5%	1	1.2%	17	0.6%
男女合計	0	0.0%	0	0.0%	0	0.0%	2	0.3%	2	0.2%	1	0.2%	2	0.3%	8	0.8%	16	2.7%	1	0.8%	32	0.6%
全体(人)																						
男性	119		166		251		374		392		263		285		497		271		38		2656	
女性	124		179		246		340		441		260		306		509		323		83		2811	
男女合計	243		345		497		714		833		523		591		1006		594		121		5467	

県 北

	10	割合	20	割合	30	割合	40	割合	50	割合	64	割合	69	割合	70～	割合	全体数	割合
1と回答																		
男性	11	31.4%	14	29.2%	32	34.8%	34	26.6%	33	28.0%	24	38.7%	22	37.3%	62	32.6%	232	31.7%
女性	17	45.9%	32	62.7%	40	45.5%	53	51.5%	64	47.4%	26	41.3%	43	52.4%	112	48.1%	387	48.9%
男女合計	28	38.9%	46	46.5%	72	40.0%	87	37.7%	97	38.3%	50	40.0%	65	46.1%	174	41.1%	619	40.6%
2と回答																		
男性	24	68.6%	34	70.8%	60	65.2%	93	72.7%	85	72.0%	38	61.3%	37	62.7%	128	67.4%	499	68.2%
女性	20	54.1%	19	37.3%	48	54.5%	50	48.5%	71	52.6%	37	58.7%	38	46.3%	118	50.6%	401	50.6%
男女合計	44	61.1%	53	53.5%	108	60.0%	143	61.9%	156	61.7%	75	60.0%	75	53.2%	246	58.2%	900	59.1%
無回答																		
男性	0	0.0%	0	0.0%	0	0.0%	1	0.8%	0	0.0%	0	0.0%	0	0.0%	0	0.0%	1	0.1%
女性	0	0.0%	0	0.0%	0	0.0%	0	0.0%	0	0.0%	0	0.0%	1	1.2%	3	1.3%	4	0.5%
男女合計	0	0.0%	0	0.0%	0	0.0%	1	0.4%	0	0.0%	0	0.0%	1	0.7%	3	0.7%	5	0.3%
全体(人)																		
男性	35		48		92		128		118		62		59		190		732	
女性	37		51		88		103		135		63		82		233		792	
男女合計	72		99		180		231		253		125		141		423		1524	

県 中

	10	割合	20	割合	30	割合	40	割合	50	割合	64	割合	69	割合	70～	割合	全体数	割合
1と回答																		
男性	12	36.4%	16	41.0%	21	43.8%	26	28.6%	26	23.9%	16	25.4%	28	36.4%	71	36.0%	216	32.9%
女性	11	37.9%	30	58.8%	30	53.6%	43	47.8%	47	45.2%	31	53.4%	29	42.6%	103	44.8%	324	47.2%
男女合計	23	37.1%	46	51.1%	51	49.0%	69	38.1%	73	34.3%	47	38.8%	57	39.3%	174	40.7%	540	40.2%
2と回答																		
男性	21	63.6%	23	59.0%	27	56.3%	65	71.4%	83	76.1%	47	74.6%	49	63.6%	124	62.9%	439	66.8%
女性	18	62.1%	21	41.2%	26	46.4%	47	52.2%	56	53.8%	27	46.6%	39	57.4%	124	53.9%	358	52.2%
男女合計	39	62.9%	44	48.9%	53	51.0%	112	61.9%	139	65.3%	74	61.2%	88	60.7%	248	58.1%	797	59.3%
無回答																		
男性	0	0.0%	0	0.0%	0	0.0%	0	0.0%	0	0.0%	0	0.0%	0	0.0%	2	1.0%	2	0.3%
女性	0	0.0%	0	0.0%	0	0.0%	0	0.0%	1	1.0%	0	0.0%	0	0.0%	3	1.3%	4	0.6%
男女合計	0	0.0%	0	0.0%	0	0.0%	0	0.0%	1	0.5%	0	0.0%	0	0.0%	5	1.2%	6	0.4%
全体(人)																		
男性	33		39		48		91		109		63		77		197		657	
女性	29		51		56		90		104		58		68		230		686	
男女合計	62		90		104		181		213		121		145		427		1343	

県 南

	10	割合	20	割合	30	割合	40	割合	50	割合	64	割合	69	割合	70～	割合	全体数	割合
1と回答																		
男性	3	42.9%	8	34.8%	4	18.2%	13	35.1%	11	32.4%	13	40.6%	14	42.4%	34	40.0%	100	36.6%
女性	9	47.4%	11	64.7%	10	55.6%	16	57.1%	24	52.2%	21	65.6%	21	72.4%	48	49.5%	160	55.9%
男女合計	12	46.2%	19	47.5%	14	35.0%	29	44.6%	35	43.8%	34	53.1%	35	56.5%	82	45.1%	260	46.5%
2と回答																		
男性	4	57.1%	15	65.2%	18	81.8%	24	64.9%	23	67.6%	19	59.4%	19	57.6%	49	57.6%	171	62.6%
女性	10	52.6%	6	35.3%	8	44.4%	12	42.9%	22	47.8%	11	34.4%	8	27.6%	48	49.5%	125	43.7%
男女合計	14	53.8%	21	52.5%	26	65.0%	36	55.4%	45	56.3%	30	46.9%	27	43.5%	97	53.3%	296	53.0%
無回答																		
男性	0	0.0%	0	0.0%	0	0.0%	0	0.0%	0	0.0%	0	0.0%	0	0.0%	2	2.4%	2	0.7%
女性	0	0.0%	0	0.0%	0	0.0%	0	0.0%	0	0.0%	0	0.0%	0	0.0%	1	1.0%	1	0.3%
男女合計	0	0.0%	0	0.0%	0	0.0%	0	0.0%	0	0.0%	0	0.0%	0	0.0%	3	1.6%	3	0.5%
全体(人)																		
男性	7		23		22		37		34		32		33		85		273	
女性	19		17		18		28		46		32		29		97		286	
男女合計	26		40		40		65		80		64		62		182		559	

会 津

	10	割合	20	割合	30	割合	40	割合	50	割合	64	割合	69	割合	70～	割合	全体数	割合
1と回答																		
男性	7	35.0%	10	35.7%	9	31.0%	11	32.4%	13	27.7%	14	28.0%	14	31.1%	43	43.9%	121	34.5%
女性	7	50.0%	14	66.7%	14	43.8%	20	58.8%	36	50.0%	18	41.9%	21	43.8%	63	54.8%	193	50.9%
男女合計	14	41.2%	24	49.0%	23	37.7%	31	45.6%	49	41.2%	32	34.4%	35	37.6%	106	49.8%	314	43.0%
2と回答																		
男性	13	65.0%	18	64.3%	20	69.0%	23	67.6%	34	72.3%	36	72.0%	31	68.9%	54	55.1%	229	65.2%
女性	7	50.0%	7	33.3%	18	56.3%	14	41.2%	36	50.0%	25	58.1%	26	54.2%	50	43.5%	183	48.3%
男女合計	20	58.8%	25	51.0%	38	62.3%	37	54.4%	70	58.8%	61	65.6%	57	61.3%	104	48.8%	412	56.4%
無回答																		
男性	0	0.0%	0	0.0%	0	0.0%	0	0.0%	0	0.0%	0	0.0%	0	0.0%	1	1.0%	1	0.3%
女性	0	0.0%	0	0.0%	0	0.0%	0	0.0%	0	0.0%	0	0.0%	1	2.1%	2	1.7%	3	0.8%
男女合計	0	0.0%	0	0.0%	0	0.0%	0	0.0%	0	0.0%	0	0.0%	1	1.1%	3	1.4%	4	0.5%
全体(人)																		
男性	20		28		29		34		47		50		45		98		351	
女性	14		21		32		34		72		43		48		115		379	
男女合計	34		49		61		68		119		93		93		213		730	

南会津

	10	割合	20	割合	30	割合	40	割合	50	割合	64	割合	69	割合	70～	割合	全体数	割合
1と回答																		
男性	0	0.0%	1	33.3%	1	33.3%	3	33.3%	4	57.1%	1	50.0%	2	33.3%	11	50.0%	23	44.2%
女性	2	100.0%	0	0.0%	0	0.0%	4	66.7%	2	50.0%	0	0.0%	4	57.1%	8	40.0%	20	42.6%
男女合計	2	100.0%	1	20.0%	1	25.0%	7	46.7%	6	54.5%	1	14.3%	6	46.2%	19	45.2%	43	43.4%
2と回答																		
男性	0	0.0%	2	66.7%	2	66.7%	5	55.6%	2	28.6%	1	50.0%	4	66.7%	11	50.0%	27	51.9%
女性	0	0.0%	2	100.0%	1	100.0%	2	33.3%	2	50.0%	5	100.0%	3	42.9%	11	55.0%	26	55.3%
男女合計	0	0.0%	4	80.0%	3	75.0%	7	46.7%	4	36.4%	6	85.7%	7	53.8%	22	52.4%	53	53.5%
無回答																		
男性	0	0.0%	0	0.0%	0	0.0%	1	11.1%	1	14.3%	0	0.0%	0	0.0%	0	0.0%	2	3.8%
女性	0	0.0%	0	0.0%	0	0.0%	0	0.0%	0	0.0%	0	0.0%	0	0.0%	1	5.0%	1	2.1%
男女合計	0	0.0%	0	0.0%	0	0.0%	1	6.7%	1	9.1%	0	0.0%	0	0.0%	1	2.4%	3	3.0%
全体(人)																		
男性	0		3		3		9		7		2		6		22		52	
女性	2		2		1		6		4		5		7		20		47	
男女合計	2		5		4		15		11		7		13		42		99	

相 双

	10	割合	20	割合	30	割合	40	割合	50	割合	64	割合	69	割合	70～	割合	全体数	割合
1と回答																		
男性	3	60.0%	0	0.0%	5	83.3%	8	53.3%	2	22.2%	6	31.6%	13	48.1%	26	33.8%	63	39.4%
女性	5	62.5%	3	50.0%	3	50.0%	14	77.8%	6	35.3%	10	55.6%	13	56.5%	28	44.4%	82	51.6%
男女合計	8	61.5%	3	37.5%	8	66.7%	22	66.7%	8	30.8%	16	43.2%	26	52.0%	54	38.6%	145	45.5%
2と回答																		
男性	2	40.0%	2	100.0%	1	16.7%	7	46.7%	7	77.8%	12	63.2%	14	51.9%	49	63.6%	94	58.8%
女性	3	37.5%	3	50.0%	3	50.0%	4	22.2%	11	64.7%	8	44.4%	10	43.5%	35	55.6%	77	48.4%
男女合計	5	38.5%	5	62.5%	4	33.3%	11	33.3%	18	69.2%	20	54.1%	24	48.0%	84	60.0%	171	53.6%
無回答																		
男性	0	0.0%	0	0.0%	0	0.0%	0	0.0%	0	0.0%	1	5.3%	0	0.0%	2	2.6%	3	1.9%
女性	0	0.0%	0	0.0%	0	0.0%	0	0.0%	0	0.0%	0	0.0%	0	0.0%	0	0.0%	0	0.0%
男女合計	0	0.0%	0	0.0%	0	0.0%	0	0.0%	0	0.0%	1	2.7%	0	0.0%	2	1.4%	3	0.9%
全体(人)																		
男性	5		2		6		15		9		19		27		77		160	
女性	8		6		6		18		17		18		23		63		159	
男女合計	13		8		12		33		26		37		50		140		319	

いわき

	10	割合	20	割合	30	割合	40	割合	50	割合	64	割合	69	割合	70～	割合	全体数	割合
1と回答																		
男性	4	21.1%	9	39.1%	14	27.5%	14	23.3%	18	26.5%	8	22.9%	9	23.7%	51	37.2%	127	29.5%
女性	5	33.3%	17	54.8%	19	42.2%	28	45.9%	20	31.7%	21	51.2%	23	46.9%	79	50.3%	212	45.9%
男女合計	9	26.5%	26	48.1%	33	34.4%	42	34.7%	38	29.0%	29	38.2%	32	36.8%	130	44.2%	339	38.0%
2と回答																		
男性	15	78.9%	14	60.9%	37	72.5%	46	76.7%	50	73.5%	27	77.1%	29	76.3%	82	59.9%	300	69.6%
女性	10	66.7%	14	45.2%	26	57.8%	33	54.1%	43	68.3%	20	48.8%	26	53.1%	74	47.1%	246	53.2%
男女合計	25	73.5%	28	51.9%	63	65.6%	79	65.3%	93	71.0%	47	61.8%	55	63.2%	156	53.1%	546	61.1%
無回答																		
男性	0	0.0%	0	0.0%	0	0.0%	0	0.0%	0	0.0%	0	0.0%	0	0.0%	4	2.9%	4	0.9%
女性	0	0.0%	0	0.0%	0	0.0%	0	0.0%	0	0.0%	0	0.0%	0	0.0%	4	2.5%	4	0.9%
男女合計	0	0.0%	0	0.0%	0	0.0%	0	0.0%	0	0.0%	0	0.0%	0	0.0%	8	2.7%	8	0.9%
全体(人)																		
男性	19		23		51		60		68		35		38		137		431	
女性	15		31		45		61		63		41		49		157		462	
男女合計	34		54		96		121		131		76		87		294		893	

全県(60歳以上・再掲)

	64	割合	69	割合	70	割合	80	割合	90	割合	全体数	割合
1と回答												
男性	82	31.2%	102	35.8%	192	38.6%	96	35.4%	10	26.3%	482	35.6%
女性	127	48.8%	154	50.3%	260	51.1%	148	45.8%	33	39.8%	722	48.8%
男女合計	209	40.0%	256	43.3%	452	44.9%	244	41.1%	43	35.5%	1204	42.5%
2と回答												
男性	180	68.4%	183	64.2%	302	60.8%	167	61.6%	28	73.7%	860	63.5%
女性	133	51.2%	150	49.0%	244	47.9%	167	51.7%	49	59.0%	743	50.2%
男女合計	313	59.8%	333	56.3%	546	54.3%	334	56.2%	77	63.6%	1603	56.5%
無回答												
男性	1	0.4%	0	0.0%	3	0.6%	8	3.0%	0	0.0%	12	0.9%
女性	0	0.0%	2	0.7%	5	1.0%	8	2.5%	1	1.2%	16	1.1%
男女合計	1	0.2%	2	0.3%	8	0.8%	16	2.7%	1	0.8%	28	1.0%
全体(人)												
男性	263		285		497		271		38		1354	
女性	260		306		509		323		83		1481	
男女合計	523		591		1006		594		121		2835	

18 外出の状況（調査票 問18）

問18 あなたは、積極的に外出するほうですか。
 （外出には日常生活の中での買物や散歩を含めます）

1 はい 2 いいえ

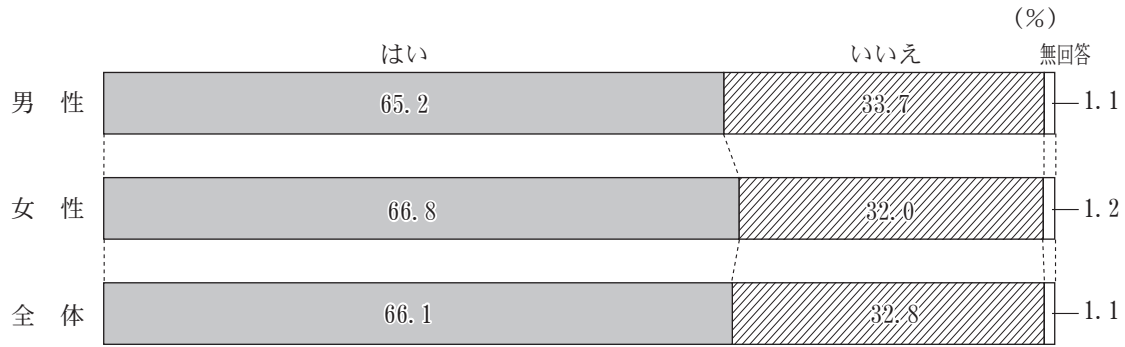

	10	割合	20	割合	30	割合	40	割合	50	割合	64	割合	69	割合	70	割合	80	割合	90	割合	全体数	割合
1と回答																						
男性	77	64.7%	102	61.4%	165	65.7%	234	62.6%	259	66.1%	163	62.0%	198	69.5%	351	70.6%	163	60.1%	21	55.3%	1733	65.2%
女性	72	58.1%	122	68.2%	162	65.9%	247	72.6%	306	69.4%	184	70.8%	229	74.8%	357	70.1%	184	57.0%	15	18.1%	1878	66.8%
男女合計	149	61.3%	224	64.9%	327	65.8%	481	67.4%	565	67.8%	347	66.3%	427	72.3%	708	70.4%	347	58.4%	36	29.8%	3611	66.1%
2と回答																						
男性	41	34.5%	64	38.6%	85	33.9%	137	36.6%	130	33.2%	99	37.6%	86	30.2%	136	27.4%	100	36.9%	16	42.1%	894	33.7%
女性	52	41.9%	56	31.3%	84	34.1%	92	27.1%	135	30.6%	72	27.7%	73	23.9%	139	27.3%	130	40.2%	67	80.7%	900	32.0%
男女合計	93	38.3%	120	34.8%	169	34.0%	229	32.1%	265	31.8%	171	32.7%	159	26.9%	275	27.3%	230	38.7%	83	68.6%	1794	32.8%
無回答																						
男性	1	0.8%	0	0.0%	1	0.4%	3	0.8%	3	0.8%	1	0.4%	1	0.4%	10	2.0%	8	3.0%	1	2.6%	29	1.1%
女性	0	0.0%	1	0.6%	0	0.0%	1	0.3%	0	0.0%	4	1.5%	4	1.3%	13	2.6%	9	2.8%	1	1.2%	33	1.2%
男女合計	1	0.4%	1	0.3%	1	0.2%	4	0.6%	3	0.4%	5	1.0%	5	0.8%	23	2.3%	17	2.9%	2	1.7%	62	1.1%
全体(人)																						
男性	119		166		251		374		392		263		285		497		271		38		2656	
女性	124		179		246		340		441		260		306		509		323		83		2811	
男女合計	243		345		497		714		833		523		591		1006		594		121		5467	

県 北

	10	割合	20	割合	30	割合	40	割合	50	割合	64	割合	69	割合	70～	割合	全体数	割合
1と回答																		
男性	23	65.7%	32	66.7%	66	71.7%	77	60.2%	78	66.1%	37	59.7%	40	67.8%	120	63.2%	473	64.6%
女性	24	64.9%	36	70.6%	59	67.0%	81	78.6%	95	70.4%	46	73.0%	61	74.4%	131	56.2%	533	67.3%
男女合計	47	65.3%	68	68.7%	125	69.4%	158	68.4%	173	68.4%	83	66.4%	101	71.6%	251	59.3%	1006	66.0%
2と回答																		
男性	12	34.3%	16	33.3%	26	28.3%	48	37.5%	40	33.9%	25	40.3%	19	32.2%	67	35.3%	253	34.6%
女性	13	35.1%	15	29.4%	29	33.0%	22	21.4%	40	29.6%	16	25.4%	21	25.6%	99	42.5%	255	32.2%
男女合計	25	34.7%	31	31.3%	55	30.6%	70	30.3%	80	31.6%	41	32.8%	40	28.4%	166	39.2%	508	33.3%
無回答																		
男性	0	0.0%	0	0.0%	0	0.0%	3	2.3%	0	0.0%	0	0.0%	0	0.0%	3	1.6%	6	0.8%
女性	0	0.0%	0	0.0%	0	0.0%	0	0.0%	0	0.0%	1	1.6%	0	0.0%	3	1.3%	4	0.5%
男女合計	0	0.0%	0	0.0%	0	0.0%	3	1.3%	0	0.0%	1	0.8%	0	0.0%	6	1.4%	10	0.7%
全体(人)																		
男性	35		48		92		128		118		62		59		190		732	
女性	37		51		88		103		135		63		82		233		792	
男女合計	72		99		180		231		253		125		141		423		1524	

県 中

	10	割合	20	割合	30	割合	40	割合	50	割合	64	割合	69	割合	70～	割合	全体数	割合
1と回答																		
男性	22	66.7%	27	69.2%	34	70.8%	56	61.5%	75	68.8%	39	61.9%	47	61.0%	132	67.0%	432	65.8%
女性	16	55.2%	38	74.5%	38	67.9%	65	72.2%	71	68.3%	39	67.2%	51	75.0%	137	59.6%	455	66.3%
男女合計	38	61.3%	65	72.2%	72	69.2%	121	66.9%	146	68.5%	78	64.5%	98	67.6%	269	63.0%	887	66.0%
2と回答																		
男性	10	30.3%	12	30.8%	14	29.2%	35	38.5%	33	30.3%	23	36.5%	29	37.7%	61	31.0%	217	33.0%
女性	13	44.8%	12	23.5%	18	32.1%	24	26.7%	33	31.7%	17	29.3%	14	20.6%	84	36.5%	215	31.3%
男女合計	23	37.1%	24	26.7%	32	30.8%	59	32.6%	66	31.0%	40	33.1%	43	29.7%	145	34.0%	432	32.2%
無回答																		
男性	1	3.0%	0	0.0%	0	0.0%	0	0.0%	1	0.9%	1	1.6%	1	1.3%	4	2.0%	8	1.2%
女性	0	0.0%	1	2.0%	0	0.0%	1	1.1%	0	0.0%	2	3.4%	3	4.4%	9	3.9%	16	2.3%
男女合計	1	1.6%	1	1.1%	0	0.0%	1	0.6%	1	0.5%	3	2.5%	4	2.8%	13	3.0%	24	1.8%
全体(人)																		
男性	33		39		48		91		109		63		77		197		657	
女性	29		51		56		90		104		58		68		230		686	
男女合計	62		90		104		181		213		121		145		427		1343	

県 南

	10	割合	20	割合	30	割合	40	割合	50	割合	64	割合	69	割合	70～	割合	全体数	割合
1と回答																		
男性	5	71.4%	11	47.8%	16	72.7%	28	75.7%	23	67.6%	18	56.3%	26	78.8%	56	65.9%	183	67.0%
女性	11	57.9%	12	70.6%	13	72.2%	20	71.4%	38	82.6%	24	75.0%	21	72.4%	63	64.9%	202	70.6%
男女合計	16	61.5%	23	57.5%	29	72.5%	48	73.8%	61	76.3%	42	65.6%	47	75.8%	119	65.4%	385	68.9%
2と回答																		
男性	2	28.6%	12	52.2%	6	27.3%	9	24.3%	11	32.4%	14	43.8%	7	21.2%	25	29.4%	86	31.5%
女性	8	42.1%	5	29.4%	5	27.8%	8	28.6%	8	17.4%	7	21.9%	8	27.6%	31	32.0%	80	28.0%
男女合計	10	38.5%	17	42.5%	11	27.5%	17	26.2%	19	23.8%	21	32.8%	15	24.2%	56	30.8%	166	29.7%
無回答																		
男性	0	0.0%	0	0.0%	0	0.0%	0	0.0%	0	0.0%	0	0.0%	0	0.0%	4	4.7%	4	1.5%
女性	0	0.0%	0	0.0%	0	0.0%	0	0.0%	0	0.0%	1	3.1%	0	0.0%	3	3.1%	4	1.4%
男女合計	0	0.0%	0	0.0%	0	0.0%	0	0.0%	0	0.0%	1	1.6%	0	0.0%	7	3.8%	8	1.4%
全体(人)																		
男性	7		23		22		37		34		32		33		85		273	
女性	19		17		18		28		46		32		29		97		286	
男女合計	26		40		40		65		80		64		62		182		559	

会 津

	10	割合	20	割合	30	割合	40	割合	50	割合	64	割合	69	割合	70～	割合	全体数	割合
1と回答																		
男性	14	70.0%	16	57.1%	14	48.3%	20	58.8%	33	70.2%	33	66.0%	32	71.1%	63	64.3%	225	64.1%
女性	7	50.0%	13	61.9%	19	59.4%	24	70.6%	51	70.8%	27	62.8%	36	75.0%	72	62.6%	249	65.7%
男女合計	21	61.8%	29	59.2%	33	54.1%	44	64.7%	84	70.6%	60	64.5%	68	73.1%	135	63.4%	474	64.9%
2と回答																		
男性	6	30.0%	12	42.9%	15	51.7%	14	41.2%	13	27.7%	17	34.0%	13	28.9%	33	33.7%	123	35.0%
女性	7	50.0%	8	38.1%	13	40.6%	10	29.4%	21	29.2%	16	37.2%	12	25.0%	36	31.3%	123	32.5%
男女合計	13	38.2%	20	40.8%	28	45.9%	24	35.3%	34	28.6%	33	35.5%	25	26.9%	69	32.4%	246	33.7%
無回答																		
男性	0	0.0%	0	0.0%	0	0.0%	0	0.0%	1	2.1%	0	0.0%	0	0.0%	2	2.0%	3	0.9%
女性	0	0.0%	0	0.0%	0	0.0%	0	0.0%	0	0.0%	0	0.0%	0	0.0%	7	6.1%	7	1.8%
男女合計	0	0.0%	0	0.0%	0	0.0%	0	0.0%	1	0.8%	0	0.0%	0	0.0%	9	4.2%	10	1.4%
全体(人)																		
男性	20		28		29		34		47		50		45		98		351	
女性	14		21		32		34		72		43		48		115		379	
男女合計	34		49		61		68		119		93		93		213		730	

南会津

	10	割合	20	割合	30	割合	40	割合	50	割合	64	割合	69	割合	70～	割合	全体数	割合
1と回答																		
男性	0	0.0%	1	33.3%	1	33.3%	7	77.8%	3	42.9%	0	0.0%	4	66.7%	21	95.5%	37	71.2%
女性	1	50.0%	2	100.0%	0	0.0%	3	50.0%	2	50.0%	5	100.0%	4	57.1%	12	60.0%	29	61.7%
男女合計	1	50.0%	3	60.0%	1	25.0%	10	66.7%	5	45.5%	5	71.4%	8	61.5%	33	78.6%	66	66.7%
2と回答																		
男性	0	0.0%	2	66.7%	2	66.7%	2	22.2%	3	42.9%	2	100.0%	2	33.3%	1	4.5%	14	26.9%
女性	1	50.0%	0	0.0%	1	100.0%	3	50.0%	2	50.0%	0	0.0%	3	42.9%	8	40.0%	18	38.3%
男女合計	1	50.0%	2	40.0%	3	75.0%	5	33.3%	5	45.5%	2	28.6%	5	38.5%	9	21.4%	32	32.3%
無回答																		
男性	0	0.0%	0	0.0%	0	0.0%	0	0.0%	1	14.3%	0	0.0%	0	0.0%	0	0.0%	1	1.9%
女性	0	0.0%	0	0.0%	0	0.0%	0	0.0%	0	0.0%	0	0.0%	0	0.0%	0	0.0%	0	0.0%
男女合計	0	0.0%	0	0.0%	0	0.0%	0	0.0%	1	9.1%	0	0.0%	0	0.0%	0	0.0%	1	1.0%
全体(人)																		
男性	0		3		3		9		7		2		6		22		52	
女性	2		2		1		6		4		5		7		20		47	
男女合計	2		5		4		15		11		7		13		42		99	

相 双

	10	割合	20	割合	30	割合	40	割合	50	割合	64	割合	69	割合	70～	割合	全体数	割合
1と回答																		
男性	4	80.0%	0	0.0%	3	50.0%	11	73.3%	4	44.4%	14	73.7%	20	74.1%	51	66.2%	107	66.9%
女性	5	62.5%	1	16.7%	5	83.3%	13	72.2%	9	52.9%	13	72.2%	17	73.9%	39	61.9%	102	64.2%
男女合計	9	69.2%	1	12.5%	8	66.7%	24	72.7%	13	50.0%	27	73.0%	37	74.0%	90	64.3%	209	65.5%
2と回答																		
男性	1	20.0%	2	100.0%	3	50.0%	4	26.7%	5	55.6%	5	26.3%	7	25.9%	23	29.9%	50	31.3%
女性	3	37.5%	5	83.3%	1	16.7%	5	27.8%	8	47.1%	5	27.8%	6	26.1%	24	38.1%	57	35.8%
男女合計	4	30.8%	7	87.5%	4	33.3%	9	27.3%	13	50.0%	10	27.0%	13	26.0%	47	33.6%	107	33.5%
無回答																		
男性	0	0.0%	0	0.0%	0	0.0%	0	0.0%	0	0.0%	0	0.0%	0	0.0%	3	3.9%	3	1.9%
女性	0	0.0%	0	0.0%	0	0.0%	0	0.0%	0	0.0%	0	0.0%	0	0.0%	0	0.0%	0	0.0%
男女合計	0	0.0%	0	0.0%	0	0.0%	0	0.0%	0	0.0%	0	0.0%	0	0.0%	3	2.1%	3	0.9%
全体(人)																		
男性	5		2		6		15		9		19		27		77		160	
女性	8		6		6		18		17		18		23		63		159	
男女合計	13		8		12		33		26		37		50		140		319	

いわき

	10	割合	20	割合	30	割合	40	割合	50	割合	64	割合	69	割合	70～	割合	全体数	割合
1と回答																		
男性	9	47.4%	15	65.2%	31	60.8%	35	58.3%	43	63.2%	22	62.9%	29	76.3%	92	67.2%	276	64.0%
女性	8	53.3%	20	64.5%	28	62.2%	41	67.2%	40	63.5%	30	73.2%	39	79.6%	102	65.0%	308	66.7%
男女合計	17	50.0%	35	64.8%	59	61.5%	76	62.8%	83	63.4%	52	68.4%	68	78.2%	194	66.0%	584	65.4%
2と回答																		
男性	10	52.6%	8	34.8%	19	37.3%	25	41.7%	25	36.8%	13	37.1%	9	23.7%	42	30.7%	151	35.0%
女性	7	46.7%	11	35.5%	17	37.8%	20	32.8%	23	36.5%	11	26.8%	9	18.4%	54	34.4%	152	32.9%
男女合計	17	50.0%	19	35.2%	36	37.5%	45	37.2%	48	36.6%	24	31.6%	18	20.7%	96	32.7%	303	33.9%
無回答																		
男性	0	0.0%	0	0.0%	1	2.0%	0	0.0%	0	0.0%	0	0.0%	0	0.0%	3	2.2%	4	0.9%
女性	0	0.0%	0	0.0%	0	0.0%	0	0.0%	0	0.0%	0	0.0%	1	2.0%	1	0.6%	2	0.4%
男女合計	0	0.0%	0	0.0%	1	1.0%	0	0.0%	0	0.0%	0	0.0%	1	1.1%	4	1.4%	6	0.7%
全体(人)																		
男性	19		23		51		60		68		35		38		137		431	
女性	15		31		45		61		63		41		49		157		462	
男女合計	34		54		96		121		131		76		87		294		893	

全県 (60歳以上・再掲)

	64	割合	69	割合	70	割合	80	割合	90	割合	全体数	割合
1と回答												
男性	163	62.0%	198	69.5%	351	70.6%	163	60.1%	21	55.3%	896	66.2%
女性	184	70.8%	229	74.8%	357	70.1%	184	57.0%	15	18.1%	969	65.4%
男女合計	347	66.3%	427	72.3%	708	70.4%	347	58.4%	36	29.8%	1865	65.8%
2と回答												
男性	99	37.6%	86	30.2%	136	27.4%	100	36.9%	16	42.1%	437	32.3%
女性	72	27.7%	73	23.9%	139	27.3%	130	40.2%	67	80.7%	481	32.5%
男女合計	171	32.7%	159	26.9%	275	27.3%	230	38.7%	83	68.6%	918	32.4%
無回答												
男性	1	0.4%	1	0.4%	10	2.0%	8	3.0%	1	2.6%	21	1.6%
女性	4	1.5%	4	1.3%	13	2.6%	9	2.8%	1	1.2%	31	2.1%
男女合計	5	1.0%	5	0.8%	23	2.3%	17	2.9%	2	1.7%	52	1.8%
全体(人)												
男性	263		285		497		271		38		1354	
女性	260		306		509		323		83		1481	
男女合計	523		591		1006		594		121		2835	

19 地域活動の実施状況（調査票 問19）

問19 あなたは、何らかの地域活動を実施していますか。（あてはまる番号すべてに○）

- 1 老人クラブ
- 2 健康・スポーツの集まりや団体
- 3 趣味の集まりや団体
- 4 社会奉仕団体（ボランティア団体）
- 5 町内会、自治会の活動
- 6 宗教団体
- 7 職場のクラブ活動など
- 8 その他
- 9 何も参加していない

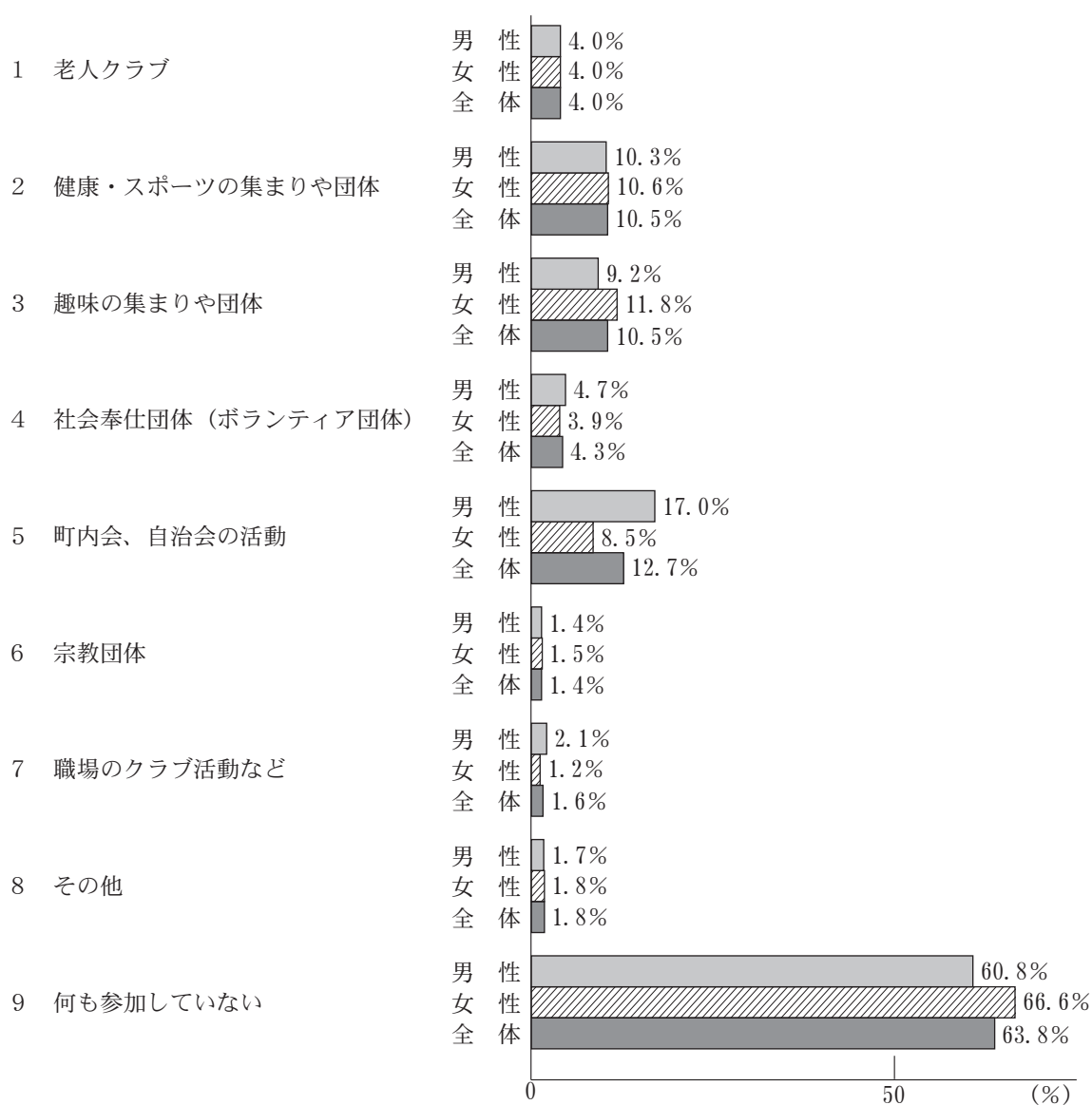

1. 老人クラブと回答した人

	10	割合	20	割合	30	割合	40	割合	50	割合	64	割合	69	割合	70	割合	80	割合	90	割合	全体数	割合
1に○																						
男性	0	0.0%	1	0.6%	1	0.4%	1	0.3%	1	0.3%	0	0.0%	7	2.5%	41	8.2%	50	18.5%	4	10.5%	106	4.0%
女性	0	0.0%	0	0.0%	0	0.0%	0	0.0%	0	0.0%	2	0.8%	5	1.6%	46	9.0%	56	17.3%	3	3.6%	112	4.0%
男女合計	0	0.0%	1	0.3%	1	0.2%	1	0.1%	1	0.1%	2	0.4%	12	2.0%	87	8.6%	106	17.8%	7	5.8%	218	4.0%
全体(人)																						
男性	119		166		251		374		392		263		285		497		271		38		2656	
女性	124		179		246		340		441		260		306		509		323		83		2811	
男女合計	243		345		497		714		833		523		591		1006		594		121		5467	

2. 健康・スポーツの集まりや団体と回答した人

	10	割合	20	割合	30	割合	40	割合	50	割合	64	割合	69	割合	70	割合	80	割合	90	割合	全体数	割合
2に○																						
男性	15	12.6%	15	9.0%	24	9.6%	28	7.5%	26	6.6%	20	7.6%	34	11.9%	63	12.7%	45	16.6%	3	7.9%	273	10.3%
女性	7	5.6%	7	3.9%	14	5.7%	17	5.0%	26	5.9%	22	8.5%	55	18.0%	102	20.0%	47	14.6%	2	2.4%	299	10.6%
男女合計	22	9.1%	22	6.4%	38	7.6%	45	6.3%	52	6.2%	42	8.0%	89	15.1%	165	16.4%	92	15.5%	5	4.1%	572	10.5%
全体(人)																						
男性	119		166		251		374		392		263		285		497		271		38		2656	
女性	124		179		246		340		441		260		306		509		323		83		2811	
男女合計	243		345		497		714		833		523		591		1006		594		121		5467	

3. 趣味の集まりや団体と回答した人

	10	割合	20	割合	30	割合	40	割合	50	割合	64	割合	69	割合	70	割合	80	割合	90	割合	全体数	割合
3に○																						
男性	4	3.4%	12	7.2%	18	7.2%	29	7.8%	25	6.4%	20	7.6%	33	11.6%	69	13.9%	31	11.4%	3	7.9%	244	9.2%
女性	2	1.6%	6	3.4%	13	5.3%	16	4.7%	31	7.0%	34	13.1%	59	19.3%	113	22.2%	53	16.4%	4	4.8%	331	11.8%
男女合計	6	2.5%	18	5.2%	31	6.2%	45	6.3%	56	6.7%	54	10.3%	92	15.6%	182	18.1%	84	14.1%	7	5.8%	575	10.5%
全体(人)																						
男性	119		166		251		374		392		263		285		497		271		38		2656	
女性	124		179		246		340		441		260		306		509		323		83		2811	
男女合計	243		345		497		714		833		523		591		1006		594		121		5467	

4. 社会奉仕団体（ボランティア団体）と回答した人

	10	割合	20	割合	30	割合	40	割合	50	割合	64	割合	69	割合	70	割合	80	割合	90	割合	全体数	割合
4に○																						
男性	3	2.5%	2	1.2%	9	3.6%	15	4.0%	16	4.1%	9	3.4%	25	8.8%	34	6.8%	12	4.4%	0	0.0%	125	4.7%
女性	2	1.6%	3	1.7%	3	1.2%	4	1.2%	15	3.4%	13	5.0%	29	9.5%	27	5.3%	15	4.6%	0	0.0%	111	3.9%
男女合計	5	2.1%	5	1.4%	12	2.4%	19	2.7%	31	3.7%	22	4.2%	54	9.1%	61	6.1%	27	4.5%	0	0.0%	236	4.3%
全体(人)																						
男性	119		166		251		374		392		263		285		497		271		38		2656	
女性	124		179		246		340		441		260		306		509		323		83		2811	
男女合計	243		345		497		714		833		523		591		1006		594		121		5467	

5. 町内会、自治会の活動と回答した人

	10	割合	20	割合	30	割合	40	割合	50	割合	64	割合	69	割合	70	割合	80	割合	90	割合	全体数	割合
5に○																						
男性	1	0.8%	8	4.8%	33	13.1%	49	13.1%	88	22.4%	72	27.4%	77	27.0%	85	17.1%	35	12.9%	4	10.5%	452	17.0%
女性	4	3.2%	3	1.7%	13	5.3%	30	8.8%	49	11.1%	27	10.4%	29	9.5%	65	12.8%	20	6.2%	0	0.0%	240	8.5%
男女合計	5	2.1%	11	3.2%	46	9.3%	79	11.1%	137	16.4%	99	18.9%	106	17.9%	150	14.9%	55	9.3%	4	3.3%	692	12.7%
全体(人)																						
男性	119		166		251		374		392		263		285		497		271		38		2656	
女性	124		179		246		340		441		260		306		509		323		83		2811	
男女合計	243		345		497		714		833		523		591		1006		594		121		5467	

6. 宗教団体と回答した人

	10	割合	20	割合	30	割合	40	割合	50	割合	64	割合	69	割合	70	割合	80	割合	90	割合	全体数	割合
6に○																						
男性	0	0.0%	1	0.6%	1	0.4%	3	0.8%	4	1.0%	7	2.7%	1	0.4%	12	2.4%	7	2.6%	0	0.0%	36	1.4%
女性	0	0.0%	2	1.1%	0	0.0%	2	0.6%	2	0.5%	11	4.2%	11	3.6%	12	2.4%	3	0.9%	0	0.0%	43	1.5%
男女合計	0	0.0%	3	0.9%	1	0.2%	5	0.7%	6	0.7%	18	3.4%	12	2.0%	24	2.4%	10	1.7%	0	0.0%	79	1.4%
全体(人)																						
男性	119		166		251		374		392		263		285		497		271		38		2656	
女性	124		179		246		340		441		260		306		509		323		83		2811	
男女合計	243		345		497		714		833		523		591		1006		594		121		5467	

7. 職場のクラブ活動などと回答した人

	10	割合	20	割合	30	割合	40	割合	50	割合	64	割合	69	割合	70	割合	80	割合	90	割合	全体数	割合
7に○																						
男性	2	1.7%	9	5.4%	6	2.4%	13	3.5%	11	2.8%	4	1.5%	5	1.8%	6	1.2%	1	0.4%	0	0.0%	57	2.1%
女性	5	4.0%	6	3.4%	3	1.2%	7	2.1%	3	0.7%	4	1.5%	1	0.3%	2	0.4%	2	0.6%	0	0.0%	33	1.2%
男女合計	7	2.9%	15	4.3%	9	1.8%	20	2.8%	14	1.7%	8	1.5%	6	1.0%	8	0.8%	3	0.5%	0	0.0%	90	1.6%
全体(人)																						
男性	119		166		251		374		392		263		285		497		271		38		2656	
女性	124		179		246		340		441		260		306		509		323		83		2811	
男女合計	243		345		497		714		833		523		591		1006		594		121		5467	

8. その他と回答した人

	10	割合	20	割合	30	割合	40	割合	50	割合	64	割合	69	割合	70	割合	80	割合	90	割合	全体数	割合
8に○																						
男性	0	0.0%	1	0.6%	0	0.0%	4	1.1%	1	0.3%	4	1.5%	9	3.2%	15	3.0%	10	3.7%	0	0.0%	44	1.7%
女性	1	0.8%	1	0.6%	3	1.2%	12	3.5%	7	1.6%	5	1.9%	8	2.6%	6	1.2%	8	2.5%	1	1.2%	52	1.8%
男女合計	1	0.4%	2	0.6%	3	0.6%	16	2.2%	8	1.0%	9	1.7%	17	2.9%	21	2.1%	18	3.0%	1	0.8%	96	1.8%
全体(人)																						
男性	119		166		251		374		392		263		285		497		271		38		2656	
女性	124		179		246		340		441		260		306		509		323		83		2811	
男女合計	243		345		497		714		833		523		591		1006		594		121		5467	

9. 何も参加していないと回答した人

	10	割合	20	割合	30	割合	40	割合	50	割合	64	割合	69	割合	70	割合	80	割合	90	割合	全体数	割合
9に○																						
男性	85	71.4%	122	73.5%	175	69.7%	256	68.4%	260	66.3%	153	58.2%	143	50.2%	256	51.5%	139	51.3%	26	68.4%	1615	60.8%
女性	100	80.6%	154	86.0%	198	80.5%	257	75.6%	324	73.5%	163	62.7%	173	56.5%	264	51.9%	176	54.5%	64	77.1%	1873	66.6%
男女合計	185	76.1%	276	80.0%	373	75.1%	513	71.8%	584	70.1%	316	60.4%	316	53.5%	520	51.7%	315	53.0%	90	74.4%	3488	63.8%
全体(人)																						
男性	119		166		251		374		392		263		285		497		271		38		2656	
女性	124		179		246		340		441		260		306		509		323		83		2811	
男女合計	243		345		497		714		833		523		591		1006		594		121		5467	

20 睡眠時間の状況（調査票 問20）

問20 あなたのふだんの睡眠時間は、どのくらいですか。（あてはまる番号1つに○）

1 4時間以下	2 5時間位	3 6時間位
4 7時間位	5 8時間位	6 9時間以上

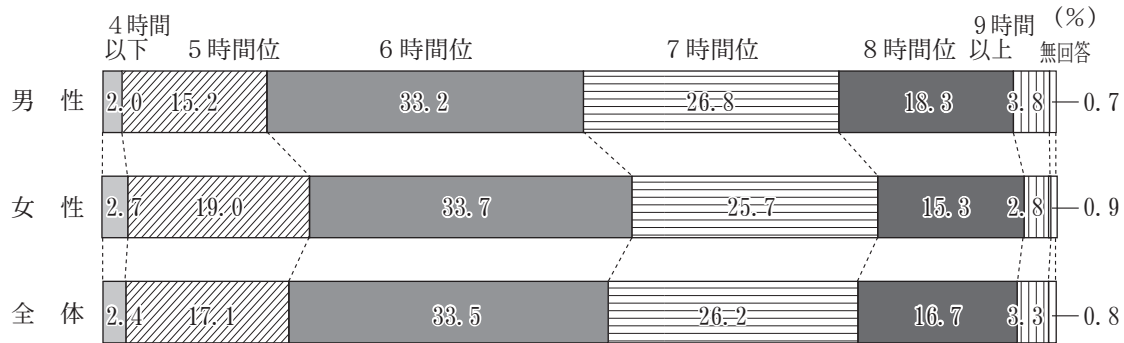

	10	割合	20	割合	30	割合	40	割合	50	割合	64	割合	69	割合	70	割合	80	割合	90	割合	全体数	割合
1と回答																						
男性	3	2.5%	3	1.8%	5	2.0%	13	3.5%	12	3.1%	5	1.9%	1	0.4%	10	2.0%	0	0.0%	1	2.6%	53	2.0%
女性	7	5.6%	6	3.4%	1	0.4%	12	3.5%	17	3.9%	7	2.7%	5	1.6%	11	2.2%	10	3.1%	0	0.0%	76	2.7%
男女合計	10	4.1%	9	2.6%	6	1.2%	25	3.5%	29	3.5%	12	2.3%	6	1.0%	21	2.1%	10	1.7%	1	0.8%	129	2.4%
2と回答																						
男性	20	16.8%	24	14.5%	45	17.9%	85	22.7%	81	20.7%	39	14.8%	44	15.4%	41	8.2%	22	8.1%	3	7.9%	404	15.2%
女性	25	20.2%	34	19.0%	45	18.3%	72	21.2%	127	28.8%	55	21.2%	43	14.1%	88	17.3%	41	12.7%	3	3.6%	533	19.0%
男女合計	45	18.5%	58	16.8%	90	18.1%	157	22.0%	208	25.0%	94	18.0%	87	14.7%	129	12.8%	63	10.6%	6	5.0%	937	17.1%
3と回答																						
男性	42	35.3%	78	47.0%	98	39.0%	144	38.5%	138	35.2%	104	39.5%	87	30.5%	134	27.0%	53	19.6%	4	10.5%	882	33.2%
女性	48	38.7%	62	34.6%	93	37.8%	127	37.4%	172	39.0%	93	35.8%	127	41.5%	156	30.6%	62	19.2%	7	8.4%	947	33.7%
男女合計	90	37.0%	140	40.6%	191	38.4%	271	38.0%	310	37.2%	197	37.7%	214	36.2%	290	28.8%	115	19.4%	11	9.1%	1829	33.5%
4と回答																						
男性	34	28.6%	40	24.1%	64	25.5%	80	21.4%	113	28.8%	70	26.6%	90	31.6%	142	28.6%	72	26.6%	8	21.1%	713	26.8%
女性	28	22.6%	45	25.1%	62	25.2%	89	26.2%	91	20.6%	68	26.2%	92	30.1%	142	27.9%	87	26.9%	18	21.7%	722	25.7%
男女合計	62	25.5%	85	24.6%	126	25.4%	169	23.7%	204	24.5%	138	26.4%	182	30.8%	284	28.2%	159	26.8%	26	21.5%	1435	26.2%
5と回答																						
男性	16	13.4%	18	10.8%	35	13.9%	44	11.8%	41	10.5%	39	14.8%	54	18.9%	138	27.8%	83	30.6%	17	44.7%	485	18.3%
女性	12	9.7%	25	14.0%	43	17.5%	39	11.5%	30	6.8%	36	13.8%	35	11.4%	90	17.7%	88	27.2%	32	38.6%	430	15.3%
男女合計	28	11.5%	43	12.5%	78	15.7%	83	11.6%	71	8.5%	75	14.3%	89	15.1%	228	22.7%	171	28.8%	49	40.5%	915	16.7%
6と回答																						
男性	4	3.4%	2	1.2%	3	1.2%	4	1.1%	5	1.3%	5	1.9%	8	2.8%	30	6.0%	35	12.9%	5	13.2%	101	3.8%
女性	4	3.2%	7	3.9%	1	0.4%	1	0.3%	3	0.7%	0	0.0%	2	0.7%	14	2.8%	26	8.0%	20	24.1%	78	2.8%
男女合計	8	3.3%	9	2.6%	4	0.8%	5	0.7%	8	1.0%	5	1.0%	10	1.7%	44	4.4%	61	10.3%	25	20.7%	179	3.3%
無回答																						
男性	0	0.0%	1	0.6%	1	0.4%	4	1.1%	2	0.5%	1	0.4%	1	0.4%	2	0.4%	6	2.2%	0	0.0%	18	0.7%
女性	0	0.0%	0	0.0%	1	0.4%	0	0.0%	1	0.2%	1	0.4%	2	0.7%	8	1.6%	9	2.8%	3	3.6%	25	0.9%
男女合計	0	0.0%	1	0.3%	2	0.4%	4	0.6%	3	0.4%	2	0.4%	3	0.5%	10	1.0%	15	2.5%	3	2.5%	43	0.8%
全体(人)																						
男性	119		166		251		374		392		263		285		497		271		38		2656	
女性	124		179		246		340		441		260		306		509		323		83		2811	
男女合計	243		345		497		714		833		523		591		1006		594		121		5467	

北 県

	10	割合	20	割合	30	割合	40	割合	50	割合	64	割合	69	割合	70～	割合	全体数	割合
1と回答																		
男性	1	2.9%	2	4.2%	1	1.1%	4	3.1%	5	4.2%	1	1.6%	0	0.0%	4	2.1%	18	2.5%
女性	3	8.1%	2	3.9%	1	1.1%	1	1.0%	6	4.4%	4	6.3%	2	2.4%	10	4.3%	29	3.7%
男女合計	4	5.6%	4	4.0%	2	1.1%	5	2.2%	11	4.3%	5	4.0%	2	1.4%	14	3.3%	47	3.1%
2と回答																		
男性	9	25.7%	8	16.7%	18	19.6%	34	26.6%	29	24.6%	5	8.1%	8	13.6%	19	10.0%	130	17.8%
女性	7	18.9%	7	13.7%	17	19.3%	20	19.4%	40	29.6%	16	25.4%	8	9.8%	35	15.0%	150	18.9%
男女合計	16	22.2%	15	15.2%	35	19.4%	54	23.4%	69	27.3%	21	16.8%	16	11.3%	54	12.8%	280	18.4%
3と回答																		
男性	10	28.6%	19	39.6%	40	43.5%	47	36.7%	40	33.9%	24	38.7%	17	28.8%	35	18.4%	232	31.7%
女性	15	40.5%	16	31.4%	34	38.0%	39	37.9%	52	38.5%	20	31.7%	36	43.9%	55	23.0%	267	33.7%
男女合計	25	34.7%	35	35.4%	74	41.1%	86	37.2%	92	36.4%	44	35.2%	53	37.6%	90	21.3%	499	32.7%
4と回答																		
男性	12	34.3%	12	25.0%	20	21.7%	28	21.9%	31	26.3%	18	29.0%	19	32.2%	63	33.2%	203	27.7%
女性	9	24.3%	14	27.5%	21	23.9%	33	32.0%	29	21.5%	17	27.0%	28	34.1%	61	26.2%	212	26.8%
男女合計	21	29.2%	26	26.3%	41	22.8%	61	26.4%	60	23.7%	35	28.0%	47	33.3%	124	29.3%	415	27.2%
5と回答																		
男性	3	8.6%	7	14.6%	12	13.0%	13	10.2%	12	10.2%	14	22.6%	15	25.4%	49	25.8%	125	17.1%
女性	2	5.4%	10	19.6%	15	17.0%	10	9.7%	7	5.2%	6	9.5%	6	7.3%	56	24.0%	112	14.1%
男女合計	5	6.9%	17	17.2%	27	15.0%	23	10.0%	19	7.5%	20	16.0%	21	14.9%	105	24.8%	237	15.6%
6と回答																		
男性	0	0.0%	0	0.0%	0	0.0%	0	0.0%	1	0.8%	0	0.0%	0	0.0%	18	9.5%	19	2.6%
女性	1	2.7%	2	3.9%	0	0.0%	0	0.0%	1	0.7%	0	0.0%	1	1.2%	13	5.6%	18	2.3%
男女合計	1	1.4%	2	2.0%	0	0.0%	0	0.0%	2	0.8%	0	0.0%	1	0.7%	31	7.3%	37	2.4%
無回答																		
男性	0	0.0%	0	0.0%	1	1.1%	2	1.6%	0	0.0%	0	0.0%	0	0.0%	2	1.1%	5	0.7%
女性	0	0.0%	0	0.0%	0	0.0%	0	0.0%	0	0.0%	0	0.0%	1	1.2%	3	1.3%	4	0.5%
男女合計	0	0.0%	0	0.0%	1	0.6%	2	0.9%	0	0.0%	0	0.0%	1	0.7%	5	1.2%	9	0.6%
全体(人)																		
男性	35		48		92		128		118		62		59		190		732	
女性	37		51		88		103		135		63		82		233		792	
男女合計	72		99		180		231		253		125		141		423		1524	

中 県

	10	割合	20	割合	30	割合	40	割合	50	割合	64	割合	69	割合	70～	割合	全体数	割合
1と回答																		
男性	1	3.0%	0	0.0%	1	2.1%	3	3.3%	4	3.7%	2	3.2%	1	1.3%	3	1.5%	15	2.3%
女性	2	6.9%	1	2.0%	0	0.0%	5	5.6%	4	3.8%	1	1.7%	0	0.0%	4	1.7%	17	2.5%
男女合計	3	4.8%	1	1.1%	1	1.0%	8	4.4%	8	3.8%	3	2.5%	1	0.7%	7	1.6%	32	2.4%
2と回答																		
男性	5	15.2%	2	5.1%	6	12.5%	19	20.9%	22	20.2%	10	15.9%	13	16.9%	16	8.1%	93	14.2%
女性	5	17.2%	12	23.5%	11	19.6%	20	22.2%	21	20.2%	10	17.2%	8	11.8%	35	15.2%	122	17.8%
男女合計	10	16.1%	14	15.6%	17	16.3%	39	21.5%	43	20.2%	20	16.5%	21	14.5%	51	11.9%	215	16.0%
3と回答																		
男性	10	30.3%	24	61.5%	20	41.7%	38	41.8%	34	31.2%	25	39.7%	25	32.5%	45	22.8%	221	33.6%
女性	11	37.9%	23	45.1%	19	33.9%	37	41.1%	44	42.3%	26	44.8%	32	47.1%	56	24.3%	248	36.2%
男女合計	21	33.9%	47	52.2%	39	37.5%	75	41.4%	78	36.6%	51	42.1%	57	39.3%	101	23.7%	469	34.9%
4と回答																		
男性	7	21.2%	10	25.6%	14	29.2%	17	18.7%	34	31.2%	14	22.2%	20	26.0%	57	28.9%	173	26.3%
女性	5	17.2%	10	19.6%	17	30.4%	18	20.3%	27	26.0%	10	17.2%	22	32.4%	65	28.3%	174	25.4%
男女合計	12	19.4%	20	22.2%	31	29.8%	35	19.3%	61	28.6%	24	19.8%	42	29.0%	122	28.6%	347	25.8%
5と回答																		
男性	7	21.2%	1	2.6%	6	12.5%	12	13.2%	13	11.9%	8	12.7%	14	18.2%	59	29.9%	120	18.3%
女性	5	17.2%	4	7.8%	9	16.1%	9	10.0%	6	5.8%	10	17.2%	5	7.4%	47	20.4%	95	13.8%
男女合計	12	19.4%	5	5.6%	15	14.4%	21	11.6%	19	8.9%	18	14.9%	19	13.1%	106	24.8%	215	16.0%
6と回答																		
男性	3	9.1%	1	2.6%	1	2.1%	1	1.1%	1	0.9%	3	4.8%	3	3.9%	16	8.1%	29	4.4%
女性	1	3.4%	1	2.0%	0	0.0%	1	1.1%	1	1.0%	0	0.0%	1	1.5%	18	7.8%	23	3.4%
男女合計	4	6.5%	2	2.2%	1	1.0%	2	1.1%	2	0.9%	3	2.5%	4	2.8%	34	8.0%	52	3.9%
無回答																		
男性	0	0.0%	1	2.6%	0	0.0%	1	1.1%	1	0.9%	1	1.6%	1	1.3%	1	0.5%	6	0.9%
女性	0	0.0%	0	0.0%	0	0.0%	0	0.0%	1	1.0%	1	1.7%	0	0.0%	5	2.2%	7	1.0%
男女合計	0	0.0%	1	1.1%	0	0.0%	1	0.6%	2	0.9%	2	1.7%	1	0.7%	6	1.4%	13	1.0%
全体(人)																		
男性	33		39		48		91		109		63		77		197		657	
女性	29		51		56		90		104		58		68		230		686	
男女合計	62		90		104		181		213		121		145		427		1343	

南 県

	10	割合	20	割合	30	割合	40	割合	50	割合	64	割合	69	割合	70～	割合	全体数	割合
1と回答																		
男性	1	14.3%	0	0.0%	0	0.0%	2	5.4%	2	5.9%	0	0.0%	0	0.0%	2	2.4%	7	2.6%
女性	1	5.3%	0	0.0%	0	0.0%	0	0.0%	2	4.3%	1	3.1%	0	0.0%	2	2.1%	6	2.1%
男女合計	2	7.7%	0	0.0%	0	0.0%	2	3.1%	4	5.0%	1	1.6%	0	0.0%	4	2.2%	13	2.3%
2と回答																		
男性	1	14.3%	5	21.7%	5	22.7%	6	16.2%	7	20.6%	3	9.4%	6	18.2%	4	4.7%	37	13.6%
女性	4	21.1%	5	29.4%	4	22.2%	5	17.9%	14	30.4%	7	21.9%	4	13.8%	11	11.3%	54	18.9%
男女合計	5	19.2%	10	25.0%	9	22.5%	11	16.9%	21	26.3%	10	15.6%	10	16.1%	15	8.2%	91	16.3%
3と回答																		
男性	1	14.3%	8	34.8%	8	36.4%	12	32.4%	7	20.6%	15	46.9%	7	21.2%	21	24.7%	79	28.9%
女性	6	31.6%	4	23.5%	5	27.8%	14	50.0%	17	37.0%	11	34.4%	7	24.1%	24	24.7%	88	30.8%
男女合計	7	26.9%	12	30.0%	13	32.5%	26	40.0%	24	30.0%	26	40.6%	14	22.6%	45	24.7%	167	29.9%
4と回答																		
男性	2	28.6%	5	21.7%	3	13.6%	8	21.6%	12	35.3%	9	28.1%	12	36.4%	19			

会 津

	10	割合	20	割合	30	割合	40	割合	50	割合	64	割合	69	割合	70～	割合	全体数	割合
1と回答	0	0.0%	0	0.0%	0	0.0%	0	0.0%	0	0.0%	0	0.0%	0	0.0%	1	1.0%	1	0.3%
男性	0	0.0%	0	0.0%	0	0.0%	0	0.0%	0	0.0%	0	0.0%	0	0.0%	0	0.0%	0	0.0%
女性	1	7.1%	1	4.8%	0	0.0%	1	2.9%	2	2.8%	1	2.3%	2	4.2%	0	0.0%	8	2.1%
男女合計	1	2.9%	1	2.0%	0	0.0%	1	1.5%	2	1.7%	1	1.1%	2	2.2%	1	0.5%	9	1.2%
2と回答	3	15.0%	2	7.1%	9	31.0%	8	23.5%	7	14.9%	10	20.0%	8	17.8%	8	8.2%	55	15.7%
男性	3	21.4%	3	14.3%	4	12.5%	9	26.5%	21	29.2%	6	14.0%	9	18.8%	9	7.8%	64	16.9%
女性	3	21.4%	3	14.3%	4	12.5%	9	26.5%	21	29.2%	6	14.0%	9	18.8%	9	7.8%	64	16.9%
男女合計	6	17.6%	5	10.2%	13	21.3%	17	25.0%	28	23.5%	16	17.2%	17	18.3%	17	8.0%	119	16.3%
3と回答	11	55.0%	18	64.3%	7	24.1%	16	47.1%	21	44.7%	19	38.0%	13	28.9%	18	18.4%	123	35.0%
男性	4	28.6%	6	28.6%	13	40.6%	11	32.4%	32	44.4%	14	32.6%	21	43.8%	28	24.3%	129	34.0%
女性	4	28.6%	6	28.6%	13	40.6%	11	32.4%	32	44.4%	14	32.6%	21	43.8%	28	24.3%	129	34.0%
男女合計	15	44.1%	24	49.0%	20	32.8%	27	39.7%	53	44.5%	33	35.5%	34	36.6%	46	21.6%	252	34.5%
4と回答	5	25.0%	6	21.4%	8	27.6%	7	20.6%	17	36.2%	14	28.0%	19	42.2%	22	22.4%	98	27.9%
男性	4	28.6%	6	28.6%	9	28.1%	10	29.4%	12	16.7%	17	39.5%	12	25.0%	30	26.1%	100	26.4%
女性	4	28.6%	6	28.6%	9	28.1%	10	29.4%	12	16.7%	17	39.5%	12	25.0%	30	26.1%	100	26.4%
男女合計	9	26.5%	12	24.5%	17	27.9%	17	25.0%	29	24.4%	31	33.3%	31	33.3%	52	24.4%	198	27.1%
5と回答	1	5.0%	2	7.1%	3	10.3%	3	8.8%	2	4.3%	7	14.0%	4	8.9%	39	39.8%	61	17.4%
男性	2	14.3%	3	14.3%	5	15.6%	3	8.8%	5	6.9%	5	11.6%	4	8.3%	32	27.8%	59	15.6%
女性	2	14.3%	3	14.3%	5	15.6%	3	8.8%	5	6.9%	5	11.6%	4	8.3%	32	27.8%	59	15.6%
男女合計	3	8.8%	5	10.2%	8	13.1%	6	8.8%	7	5.9%	12	12.9%	8	8.6%	71	33.3%	120	16.4%
6と回答	0	0.0%	0	0.0%	2	6.9%	0	0.0%	0	0.0%	0	0.0%	1	2.2%	9	9.2%	12	3.4%
男性	0	0.0%	0	0.0%	1	3.1%	0	0.0%	0	0.0%	0	0.0%	0	0.0%	13	11.3%	16	4.2%
女性	0	0.0%	0	0.0%	1	3.1%	0	0.0%	0	0.0%	0	0.0%	0	0.0%	13	11.3%	16	4.2%
男女合計	0	0.0%	2	4.1%	3	4.9%	0	0.0%	0	0.0%	0	0.0%	1	1.1%	22	10.3%	28	3.8%
無回答	0	0.0%	0	0.0%	0	0.0%	0	0.0%	0	0.0%	0	0.0%	0	0.0%	1	1.0%	1	0.3%
男性	0	0.0%	0	0.0%	0	0.0%	0	0.0%	0	0.0%	0	0.0%	0	0.0%	3	2.6%	3	0.8%
女性	0	0.0%	0	0.0%	0	0.0%	0	0.0%	0	0.0%	0	0.0%	0	0.0%	4	1.9%	4	0.5%
男女合計	0	0.0%	0	0.0%	0	0.0%	0	0.0%	0	0.0%	0	0.0%	0	0.0%	4	1.9%	4	0.5%
全体(人)	20		28		29		34		47		50		45		98		351	
男性	14		21		32		34		72		43		48		115		379	
女性	6		7		7		0		7		7		7		7		72	
男女合計	34		49		61		68		119		93		93		213		730	

南 会 津

	10	割合	20	割合	30	割合	40	割合	50	割合	64	割合	69	割合	70～	割合	全体数	割合
1と回答	0	0.0%	0	0.0%	1	33.3%	0	0.0%	0	0.0%	0	0.0%	0	0.0%	0	0.0%	1	1.9%
男性	0	0.0%	0	0.0%	0	0.0%	0	0.0%	0	0.0%	0	0.0%	0	0.0%	0	0.0%	0	0.0%
女性	0	0.0%	0	0.0%	1	25.0%	0	0.0%	0	0.0%	0	0.0%	0	0.0%	0	0.0%	1	1.0%
男女合計	0	0.0%	0	0.0%	1	25.0%	0	0.0%	0	0.0%	0	0.0%	0	0.0%	0	0.0%	1	1.0%
2と回答	0	0.0%	0	0.0%	0	0.0%	1	11.1%	2	28.6%	1	50.0%	2	33.3%	2	9.1%	8	15.4%
男性	1	50.0%	0	0.0%	0	0.0%	1	16.7%	2	50.0%	1	20.0%	0	0.0%	0	0.0%	5	10.6%
女性	1	50.0%	0	0.0%	0	0.0%	2	13.3%	4	36.4%	2	28.6%	2	15.4%	2	4.8%	13	13.1%
男女合計	1	50.0%	0	0.0%	0	0.0%	2	13.3%	4	36.4%	2	28.6%	2	15.4%	2	4.8%	13	13.1%
3と回答	0	0.0%	1	33.3%	1	33.3%	4	44.4%	2	28.6%	0	0.0%	2	33.3%	9	40.9%	19	36.5%
男性	1	50.0%	2	100.0%	0	0.0%	3	50.0%	2	50.0%	0	0.0%	6	85.7%	6	30.0%	20	42.6%
女性	1	50.0%	3	60.0%	1	25.0%	7	46.7%	4	36.4%	0	0.0%	8	61.5%	15	35.7%	39	39.4%
男女合計	1	50.0%	3	60.0%	1	25.0%	7	46.7%	4	36.4%	0	0.0%	8	61.5%	15	35.7%	39	39.4%
4と回答	0	0.0%	1	33.3%	1	33.3%	2	22.2%	0	0.0%	0	0.0%	1	16.7%	3	13.6%	8	15.4%
男性	0	0.0%	0	0.0%	1	100.0%	2	33.3%	0	0.0%	2	40.0%	1	14.3%	7	35.0%	13	27.7%
女性	0	0.0%	1	20.0%	2	50.0%	4	26.7%	0	0.0%	2	28.6%	2	15.4%	10	23.8%	21	21.2%
男女合計	0	0.0%	1	20.0%	2	50.0%	4	26.7%	0	0.0%	2	28.6%	2	15.4%	10	23.8%	21	21.2%
5と回答	0	0.0%	1	33.3%	0	0.0%	2	22.2%	1	14.3%	1	50.0%	1	16.7%	7	31.8%	13	25.0%
男性	0	0.0%	0	0.0%	0	0.0%	0	0.0%	0	0.0%	2	40.0%	0	0.0%	7	35.0%	9	19.1%
女性	0	0.0%	1	20.0%	0	0.0%	2	13.3%	1	9.1%	3	42.9%	1	7.7%	14	33.3%	22	22.2%
男女合計	0	0.0%	1	20.0%	0	0.0%	2	13.3%	1	9.1%	3	42.9%	1	7.7%	14	33.3%	22	22.2%
6と回答	0	0.0%	0	0.0%	0	0.0%	0	0.0%	1	14.3%	0	0.0%	0	0.0%	1	4.5%	2	3.8%
男性	0	0.0%	0	0.0%	0	0.0%	0	0.0%	0	0.0%	0	0.0%	0	0.0%	0	0.0%	0	0.0%
女性	0	0.0%	0	0.0%	0	0.0%	0	0.0%	1	14.3%	0	0.0%	0	0.0%	1	4.5%	2	3.8%
男女合計	0	0.0%	0	0.0%	0	0.0%	0	0.0%	1	9.1%	0	0.0%	0	0.0%	1	2.4%	2	2.0%
無回答	0	0.0%	0	0.0%	0	0.0%	0	0.0%	1	14.3%	0	0.0%	0	0.0%	0	0.0%	1	1.9%
男性	0	0.0%	0	0.0%	0	0.0%	0	0.0%	0	0.0%	0	0.0%	0	0.0%	0	0.0%	0	0.0%
女性	0	0.0%	0	0.0%	0	0.0%	0	0.0%	1	14.3%	0	0.0%	0	0.0%	0	0.0%	1	1.0%
男女合計	0	0.0%	0	0.0%	0	0.0%	0	0.0%	1	9.1%	0	0.0%	0	0.0%	0	0.0%	1	1.0%
全体(人)	0		3		3		9		7		2		6		22		52	
男性	2		2		1		6		4		5		7		20		47	
女性	2		5		4		15		11		7		13		42		99	
男女合計	2		5		4		15		11		7		13		42		99	

相 双

	10	割合	20	割合	30	割合	40	割合	50	割合	64	割合	69	割合	70～	割合	全体数	割合
1と回答	0	0.0%	0	0.0%	0	0.0%	0	0.0%	0	0.0%	1	5.3%	0	0.0%	1	1.3%	2	1.3%
男性	0	0.0%	1	16.7%	0	0.0%	1	5.6%	0	0.0%	0	0.0%	0	0.0%	2	3.2%	4	2.5%
女性	0	0.0%	1	12.5%	0	0.0%	1	3.0%	0	0.0%	1	2.7%	0	0.0%	3	2.1%	6	1.9%
男女合計	0	0.0%	1	12.5%	0	0.0%	1	3.0%	0	0.0%	1	2.7%	0	0.0%	3	2.1%	6	1.9%
2と回答	0	0.0%	1	50.0%	0	0.0%	2	13.3%	1	11.1%	2	10.5%	3	11.1%	6	7.8%	15	9.4%
男性	3	37.5%	0	0.0%	2	33.3%	4	22.2%	7	41.2%	4	22.2%	2	8.7%	10	15.9%	32	20.1%
女性	3	23.1%	1	12.5%	2	16.7%	6	18.2%	8	30.8%	6	16.2%	5	10.0%	16	11.4%	47	14.7%
男女合計	3	23.1%	1	12.5%	2	16.7%	6	18.2%	8	30.8%	6	16.2%	5	10.0%	16	11.4%	47	14.7%
3と回答	3	60.0%	1	50.0%	5	83.3%	6	40.0%	4</									

いわき

	10	割合	20	割合	30	割合	40	割合	50	割合	64	割合	69	割合	70～	割合	全体数	割合
1と回答																		
男性	0	0.0%	1	4.3%	2	3.9%	4	6.7%	1	1.5%	1	2.9%	0	0.0%	0	0.0%	9	2.1%
女性	0	0.0%	1	3.2%	0	0.0%	4	6.6%	3	4.8%	0	0.0%	1	2.0%	3	1.9%	12	2.6%
男女合計	0	0.0%	2	3.7%	2	2.1%	8	6.6%	4	3.1%	1	1.3%	1	1.1%	3	1.0%	21	2.4%
2と回答																		
男性	2	10.5%	6	26.1%	7	13.7%	15	25.0%	13	19.1%	8	22.9%	4	10.5%	11	8.0%	66	15.3%
女性	2	13.3%	7	22.6%	7	15.6%	13	21.3%	22	34.9%	11	26.8%	12	24.5%	32	20.4%	106	22.9%
男女合計	4	11.8%	13	24.1%	14	14.6%	28	23.1%	35	26.7%	19	25.0%	16	18.4%	43	14.6%	172	19.3%
3と回答																		
男性	7	36.8%	7	30.4%	17	33.3%	21	35.0%	30	44.1%	13	37.1%	15	39.5%	41	29.9%	151	35.0%
女性	8	53.3%	10	32.3%	21	46.7%	21	34.4%	20	31.7%	17	41.5%	14	28.6%	39	24.8%	150	32.5%
男女合計	15	44.1%	17	31.5%	38	39.6%	42	34.7%	50	38.2%	30	39.5%	29	33.3%	80	27.2%	301	33.7%
4と回答																		
男性	7	36.8%	6	26.1%	17	33.3%	12	20.0%	15	22.1%	11	31.4%	11	28.9%	36	26.3%	115	26.7%
女性	4	26.7%	8	25.8%	9	20.0%	14	23.0%	13	20.6%	10	24.4%	13	26.5%	39	24.8%	110	23.8%
男女合計	11	32.4%	14	25.9%	26	27.1%	26	21.5%	28	21.4%	21	27.6%	24	27.6%	75	25.5%	225	25.2%
5と回答																		
男性	2	10.5%	3	13.0%	8	15.7%	7	11.7%	7	10.3%	2	5.7%	5	13.2%	33	24.1%	67	15.5%
女性	1	6.7%	5	16.1%	7	15.6%	9	14.8%	5	7.9%	3	7.3%	8	16.3%	35	22.3%	73	15.8%
男女合計	3	8.8%	8	14.8%	15	15.6%	16	13.2%	12	9.2%	5	6.6%	13	14.9%	68	23.1%	140	15.7%
6と回答																		
男性	1	5.3%	0	0.0%	0	0.0%	0	0.0%	2	2.9%	0	0.0%	3	7.9%	13	9.5%	19	4.4%
女性	0	0.0%	0	0.0%	0	0.0%	0	0.0%	0	0.0%	0	0.0%	0	0.0%	8	5.1%	8	1.7%
男女合計	1	2.9%	0	0.0%	0	0.0%	0	0.0%	2	1.5%	0	0.0%	3	3.4%	21	7.1%	27	3.0%
無回答																		
男性	0	0.0%	0	0.0%	0	0.0%	1	1.7%	0	0.0%	0	0.0%	0	0.0%	3	2.2%	4	0.9%
女性	0	0.0%	0	0.0%	1	2.2%	0	0.0%	0	0.0%	0	0.0%	1	2.0%	1	0.6%	3	0.6%
男女合計	0	0.0%	0	0.0%	1	1.0%	1	0.8%	0	0.0%	0	0.0%	1	1.1%	4	1.4%	7	0.8%
全体(人)																		
男性	19		23		51		60		68		35		38		137		431	
女性	15		31		45		61		63		41		49		157		462	
男女合計	34		54		96		121		131		76		87		294		893	

全県 (60歳以上・再掲)

	64	割合	69	割合	70	割合	80	割合	90	割合	全体数	割合
1と回答												
男性	5	1.9%	1	0.4%	10	2.0%	0	0.0%	1	2.6%	17	1.3%
女性	7	2.7%	5	1.6%	11	2.2%	10	3.1%	0	0.0%	33	2.2%
男女合計	12	2.3%	6	1.0%	21	2.1%	10	1.7%	1	0.8%	50	1.8%
2と回答												
男性	39	14.8%	44	15.4%	41	8.2%	22	8.1%	3	7.9%	149	11.0%
女性	55	21.2%	43	14.1%	88	17.3%	41	12.7%	3	3.6%	230	15.5%
男女合計	94	18.0%	87	14.7%	129	12.8%	63	10.6%	6	5.0%	379	13.4%
3と回答												
男性	104	39.5%	87	30.5%	134	27.0%	53	19.6%	4	10.5%	382	28.2%
女性	93	35.8%	127	41.5%	156	30.6%	62	19.2%	7	8.4%	445	30.0%
男女合計	197	37.7%	214	36.2%	290	28.8%	115	19.4%	11	9.1%	827	29.2%
4と回答												
男性	70	26.6%	90	31.6%	142	28.6%	72	26.6%	8	21.1%	382	28.2%
女性	68	26.2%	92	30.1%	142	27.9%	87	26.9%	18	21.7%	407	27.5%
男女合計	138	26.4%	182	30.8%	284	28.2%	159	26.8%	26	21.5%	789	27.8%
5と回答												
男性	39	14.8%	54	18.9%	138	27.8%	83	30.6%	17	44.7%	331	24.4%
女性	36	13.8%	35	11.4%	90	17.7%	88	27.2%	32	38.6%	281	19.0%
男女合計	75	14.3%	89	15.1%	228	22.7%	171	28.8%	49	40.5%	612	21.6%
6と回答												
男性	5	1.9%	8	2.8%	30	6.0%	35	12.9%	5	13.2%	83	6.1%
女性	0	0.0%	2	0.7%	14	2.8%	26	8.0%	20	24.1%	62	4.2%
男女合計	5	1.0%	10	1.7%	44	4.4%	61	10.3%	25	20.7%	145	5.1%
無回答												
男性	1	0.4%	1	0.4%	2	0.4%	6	2.2%	0	0.0%	10	0.7%
女性	1	0.4%	2	0.7%	8	1.6%	9	2.8%	3	3.6%	23	1.6%
男女合計	2	0.4%	3	0.5%	10	1.0%	15	2.5%	3	2.5%	33	1.2%
全体(人)												
男性	263		285		497		271		38		1354	
女性	260		306		509		323		83		1481	
男女合計	523		591		1006		594		121		2835	

21 疲労の状況（調査票 問21）

問21 あなたは、疲れすぎたと感じていますか。（あてはまる番号1つに○）

1 感じている 2 あまり感じていない 3 まったく感じていない

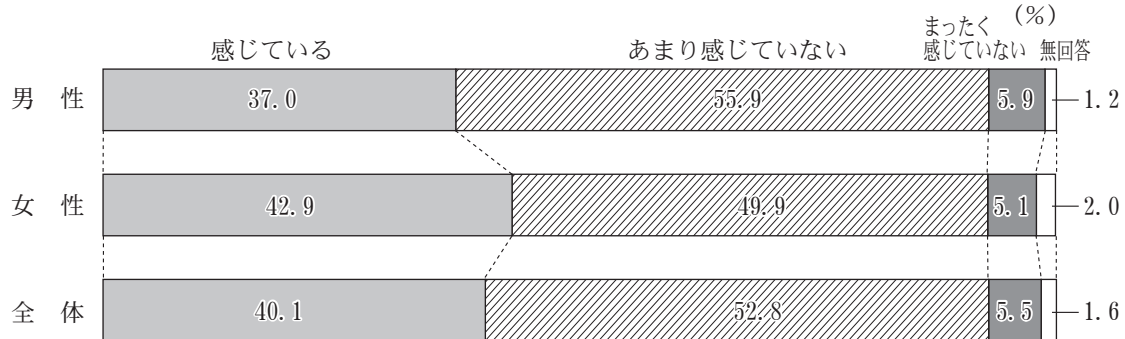

	10	割合	20	割合	30	割合	40	割合	50	割合	64	割合	69	割合	70	割合	80	割合	90	割合	全体数	割合
1と回答																						
男性	29	24.4%	62	37.3%	107	42.6%	158	42.2%	179	45.7%	101	38.4%	87	30.5%	159	32.0%	94	34.7%	8	21.1%	984	37.0%
女性	45	36.3%	79	44.1%	138	56.1%	173	50.9%	234	53.1%	105	40.4%	104	34.0%	181	35.6%	126	39.0%	22	26.5%	1207	42.9%
男女合計	74	30.5%	141	40.9%	245	49.3%	331	46.4%	413	49.6%	206	39.4%	191	32.3%	340	33.8%	220	37.0%	30	24.8%	2191	40.1%
2と回答																						
男性	77	64.7%	91	54.8%	135	53.8%	187	50.0%	200	51.0%	152	57.8%	175	61.4%	301	60.6%	145	53.5%	22	57.9%	1485	55.9%
女性	72	58.1%	93	52.0%	95	38.6%	154	45.3%	185	42.0%	144	55.4%	177	57.8%	287	56.4%	156	48.3%	40	48.2%	1403	49.9%
男女合計	149	61.3%	184	53.3%	230	46.3%	341	47.8%	385	46.2%	296	56.6%	352	59.6%	588	58.4%	301	50.7%	62	51.2%	2888	52.8%
3と回答																						
男性	13	10.9%	13	7.8%	9	3.6%	25	6.7%	11	2.8%	10	3.8%	19	6.7%	29	5.8%	20	7.4%	7	18.4%	156	5.9%
女性	7	5.6%	6	3.4%	11	4.5%	12	3.5%	15	3.4%	8	3.1%	18	5.9%	29	5.7%	21	6.5%	17	20.5%	144	5.1%
男女合計	20	8.2%	19	5.5%	20	4.0%	37	5.2%	26	3.1%	18	3.4%	37	6.3%	58	5.8%	41	6.9%	24	19.8%	300	5.5%
無回答																						
男性	0	0.0%	0	0.0%	0	0.0%	4	1.1%	2	0.5%	0	0.0%	4	1.4%	8	1.6%	12	4.4%	1	2.6%	31	1.2%
女性	0	0.0%	1	0.6%	2	0.8%	1	0.3%	7	1.6%	3	1.2%	7	2.3%	12	2.4%	20	6.2%	4	4.8%	57	2.0%
男女合計	0	0.0%	1	0.3%	2	0.4%	5	0.7%	9	1.1%	3	0.6%	11	1.9%	20	2.0%	32	5.4%	5	4.1%	88	1.6%
全体(人)																						
男性	119		166		251		374		392		263		285		497		271		38		2656	
女性	124		179		246		340		441		260		306		509		323		83		2811	
男女合計	243		345		497		714		833		523		591		1006		594		121		5467	

県 北

	10	割合	20	割合	30	割合	40	割合	50	割合	64	割合	69	割合	70～	割合	全体数	割合
1と回答																		
男性	9	25.7%	16	33.3%	39	42.4%	51	39.8%	54	45.8%	15	24.2%	16	27.1%	67	35.3%	267	36.5%
女性	11	29.7%	28	54.9%	48	54.5%	50	48.5%	68	50.4%	25	39.7%	29	35.4%	71	30.5%	330	41.7%
男女合計	20	27.8%	44	44.4%	87	48.3%	101	43.7%	122	48.2%	40	32.0%	45	31.9%	138	32.6%	597	39.2%
2と回答																		
男性	23	65.7%	26	54.2%	51	55.4%	66	51.6%	61	51.7%	44	71.0%	38	64.4%	104	54.7%	413	56.4%
女性	23	62.2%	19	37.3%	37	42.0%	50	48.5%	58	43.0%	34	54.0%	44	53.7%	127	54.5%	392	49.5%
男女合計	46	63.9%	45	45.5%	88	48.9%	116	50.2%	119	47.0%	78	62.4%	82	58.2%	231	54.6%	805	52.8%
3と回答																		
男性	3	8.6%	6	12.5%	2	2.2%	9	7.0%	3	2.5%	3	4.8%	4	6.8%	13	6.8%	43	5.9%
女性	3	8.1%	4	7.8%	3	3.4%	3	2.9%	6	4.4%	3	4.8%	7	8.5%	23	9.9%	52	6.6%
男女合計	6	8.3%	10	10.1%	5	2.8%	12	5.2%	9	3.6%	6	4.8%	11	7.8%	36	8.5%	95	6.2%
無回答																		
男性	0	0.0%	0	0.0%	0	0.0%	2	1.6%	0	0.0%	0	0.0%	1	1.7%	6	3.2%	9	1.2%
女性	0	0.0%	0	0.0%	0	0.0%	0	0.0%	3	2.2%	1	1.6%	2	2.4%	12	5.2%	18	2.3%
男女合計	0	0.0%	0	0.0%	0	0.0%	2	0.9%	3	1.2%	1	0.8%	3	2.1%	18	4.3%	27	1.8%
全体(人)																		
男性	35		48		92		128		118		62		59		190		732	
女性	37		51		88		103		135		63		82		233		792	
男女合計	72		99		180		231		253		125		141		423		1524	

県 中

	10	割合	20	割合	30	割合	40	割合	50	割合	64	割合	69	割合	70～	割合	全体数	割合
1と回答																		
男性	10	30.3%	15	38.5%	28	58.3%	37	40.7%	53	48.6%	29	46.0%	26	33.8%	57	28.9%	255	38.8%
女性	12	41.4%	17	33.3%	29	51.8%	53	58.9%	52	50.0%	22	37.9%	25	36.8%	82	35.7%	292	42.6%
男女合計	22	35.5%	32	35.6%	57	54.8%	90	49.7%	105	49.3%	51	42.1%	51	35.2%	139	32.6%	547	40.7%
2と回答																		
男性	20	60.6%	23	59.0%	20	41.7%	46	50.5%	51	46.8%	31	49.2%	46	59.7%	121	61.4%	358	54.5%
女性	15	51.7%	32	62.7%	24	42.9%	37	41.1%	45	43.3%	34	58.6%	38	55.9%	118	51.3%	343	50.0%
男女合計	35	56.5%	55	61.1%	44	42.3%	83	45.9%	96	45.1%	65	53.7%	84	57.9%	239	56.0%	701	52.2%
3と回答																		
男性	3	9.1%	1	2.6%	0	0.0%	7	7.7%	4	3.7%	3	4.8%	5	6.5%	13	6.6%	36	5.5%
女性	2	6.9%	1	2.0%	2	3.6%	0	0.0%	3	2.9%	1	1.7%	4	5.9%	20	8.7%	33	4.8%
男女合計	5	8.1%	2	2.2%	2	1.9%	7	3.9%	7	3.3%	4	3.3%	9	6.2%	33	7.7%	69	5.1%
無回答																		
男性	0	0.0%	0	0.0%	0	0.0%	1	1.1%	1	0.9%	0	0.0%	0	0.0%	6	3.0%	8	1.2%
女性	0	0.0%	1	2.0%	1	1.8%	0	0.0%	4	3.8%	1	1.7%	1	1.5%	10	4.3%	18	2.6%
男女合計	0	0.0%	1	1.1%	1	1.0%	1	0.6%	5	2.3%	1	0.8%	1	0.7%	16	3.7%	26	1.9%
全体(人)																		
男性	33		39		48		91		109		63		77		197		657	
女性	29		51		56		90		104		58		68		230		686	
男女合計	62		90		104		181		213		121		145		427		1343	

県 南

	10	割合	20	割合	30	割合	40	割合	50	割合	64	割合	69	割合	70～	割合	全体数	割合
1と回答																		
男性	2	28.6%	8	34.8%	6	27.3%	18	48.6%	12	35.3%	15	46.9%	13	39.4%	33	38.8%	107	39.2%
女性	11	57.9%	8	47.1%	11	61.1%	16	57.1%	26	56.5%	15	46.9%	9	31.0%	37	38.1%	133	46.5%
男女合計	13	50.0%	16	40.0%	17	42.5%	34	52.3%	38	47.5%	30	46.9%	22	35.5%	70	38.5%	240	42.9%
2と回答																		
男性	5	71.4%	14	60.9%	13	59.1%	17	45.9%	21	61.8%	17	53.1%	15	45.5%	44	51.8%	146	53.5%
女性	8	42.1%	8	47.1%	5	27.8%	12	42.9%	20	43.5%	16	50.0%	19	65.5%	49	50.5%	137	47.9%
男女合計	13	50.0%	22	55.0%	18	45.0%	29	44.6%	41	51.3%	33	51.6%	34	54.8%	93	51.1%	283	50.6%
3と回答																		
男性	0	0.0%	1	4.3%	3	13.6%	2	5.4%	1	2.9%	0	0.0%	4	12.1%	6	7.1%	17	6.2%
女性	0	0.0%	1	5.9%	2	11.1%	0	0.0%	0	0.0%	0	0.0%	0	0.0%	8	8.2%	11	3.8%
男女合計	0	0.0%	2	5.0%	5	12.5%	2	3.1%	1	1.3%	0	0.0%	4	6.5%	14	7.7%	28	5.0%
無回答																		
男性	0	0.0%	0	0.0%	0	0.0%	0	0.0%	0	0.0%	0	0.0%	1	3.0%	2	2.4%	3	1.1%
女性	0	0.0%	0	0.0%	0	0.0%	0	0.0%	0	0.0%	1	3.1%	1	3.4%	3	3.1%	5	1.7%
男女合計	0	0.0%	0	0.0%	0	0.0%	0	0.0%	0	0.0%	1	1.6%	2	3.2%	5	2.7%	8	1.4%
全体(人)																		
男性	7		23		22		37		34		32		33		85		273	
女性	19		17		18		28		46		32		29		97		286	
男女合計	26		40		40		65		80		64		62		182		559	

会 津

	10	割合	20	割合	30	割合	40	割合	50	割合	64	割合	69	割合	70～	割合	全体数	割合
1と回答																		
男性	5	25.0%	10	35.7%	13	44.8%	13	38.2%	22	46.8%	17	34.0%	14	31.1%	30	30.6%	124	35.3%
女性	6	42.9%	11	52.4%	22	68.8%	12	35.3%	37	51.4%	19	44.2%	12	25.0%	48	41.7%	167	44.1%
男女合計	11	32.4%	21	42.9%	35	57.4%	25	36.8%	59	49.6%	36	38.7%	26	28.0%	78	36.6%	291	39.9%
2と回答																		
男性	12	60.0%	16	57.1%	15	51.7%	19	55.9%	23	48.9%	32	64.0%	27	60.0%	55	56.1%	199	56.7%
女性	8	57.1%	10	47.6%	10	31.3%	20	58.8%	29	40.3%	23	53.5%	30	62.5%	55	47.8%	185	48.8%
男女合計	20	58.8%	26	53.1%	25	41.0%	39	57.4%	52	43.7%	55	59.1%	57	61.3%	110	51.6%	384	52.6%
3と回答																		
男性	3	15.0%	2	7.1%	1	3.4%	2	5.9%	2	4.3%	1	2.0%	2	4.4%	9	9.2%	22	6.3%
女性	0	0.0%	0	0.0%	0	0.0%	2	5.9%	6	8.3%	1	2.3%	3	6.3%	7	6.1%	19	5.0%
男女合計	3	8.8%	2	4.1%	1	1.6%	4	5.9%	8	6.7%	2	2.2%	5	5.4%	16	7.5%	41	5.6%
無回答																		
男性	0	0.0%	0	0.0%	0	0.0%	0	0.0%	0	0.0%	0	0.0%	2	4.4%	4	4.1%	6	1.7%
女性	0	0.0%	0	0.0%	0	0.0%	0	0.0%	0	0.0%	0	0.0%	3	6.3%	5	4.3%	8	2.1%
男女合計	0	0.0%	0	0.0%	0	0.0%	0	0.0%	0	0.0%	0	0.0%	5	5.4%	9	4.2%	14	1.9%
全体(人)																		
男性	20		28		29		34		47		50		45		98		351	
女性	14		21		32		34		72		43		48		115		379	
男女合計	34		49		61		68		119		93		93		213		730	

南 会 津

	10	割合	20	割合	30	割合	40	割合	50	割合	64	割合	69	割合	70～	割合	全体数	割合
1と回答																		
男性	0	0.0%	1	33.3%	1	33.3%	2	22.2%	4	57.1%	0	0.0%	1	16.7%	9	40.9%	18	34.6%
女性	0	0.0%	0	0.0%	0	0.0%	3	50.0%	4	100.0%	3	60.0%	4	57.1%	8	40.0%	22	46.8%
男女合計	0	0.0%	1	20.0%	1	25.0%	5	33.3%	8	72.7%	3	42.9%	5	38.5%	17	40.5%	40	40.4%
2と回答																		
男性	0	0.0%	2	66.7%	2	66.7%	6	66.7%	2	28.6%	2	100.0%	5	83.3%	11	50.0%	30	57.7%
女性	2	100.0%	2	100.0%	1	100.0%	3	50.0%	0	0.0%	2	40.0%	3	42.9%	11	55.0%	24	51.1%
男女合計	2	100.0%	4	80.0%	3	75.0%	9	60.0%	2	18.2%	4	57.1%	8	61.5%	22	52.4%	54	54.5%
3と回答																		
男性	0	0.0%	0	0.0%	0	0.0%	1	11.1%	0	0.0%	0	0.0%	0	0.0%	1	4.5%	2	3.8%
女性	0	0.0%	0	0.0%	0	0.0%	0	0.0%	0	0.0%	0	0.0%	0	0.0%	1	5.0%	1	2.1%
男女合計	0	0.0%	0	0.0%	0	0.0%	1	6.7%	0	0.0%	0	0.0%	0	0.0%	2	4.8%	3	3.0%
無回答																		
男性	0	0.0%	0	0.0%	0	0.0%	0	0.0%	1	14.3%	0	0.0%	0	0.0%	1	4.5%	2	3.8%
女性	0	0.0%	0	0.0%	0	0.0%	0	0.0%	0	0.0%	0	0.0%	0	0.0%	0	0.0%	0	0.0%
男女合計	0	0.0%	0	0.0%	0	0.0%	0	0.0%	1	9.1%	0	0.0%	0	0.0%	1	2.4%	2	2.0%
全体(人)																		
男性	0		3		3		9		7		2		6		22		52	
女性	2		2		1		6		4		5		7		20		47	
男女合計	2		5		4		15		11		7		13		42		99	

相 双

	10	割合	20	割合	30	割合	40	割合	50	割合	64	割合	69	割合	70～	割合	全体数	割合
1と回答																		
男性	1	20.0%	2	100.0%	0	0.0%	6	40.0%	6	66.7%	6	31.6%	6	22.2%	26	33.8%	53	33.1%
女性	1	12.5%	4	66.7%	2	33.3%	8	44.4%	12	70.6%	8	44.4%	9	39.1%	30	47.6%	74	46.5%
男女合計	2	15.4%	6	75.0%	2	16.7%	14	42.4%	18	69.2%	14	37.8%	15	30.0%	56	40.0%	127	39.8%
2と回答																		
男性	3	60.0%	0	0.0%	5	83.3%	8	53.3%	3	33.3%	11	57.9%	19	70.4%	47	61.0%	96	60.0%
女性	5	62.5%	2	33.3%	3	50.0%	7	38.9%	5	29.4%	9	50.0%	12	52.2%	30	47.6%	73	45.9%
男女合計	8	61.5%	2	25.0%	8	66.7%	15	45.5%	8	30.8%	20	54.1%	31	62.0%	77	55.0%	169	53.0%
3と回答																		
男性	1	20.0%	0	0.0%	1	16.7%	1	6.7%	0	0.0%	2	10.5%	2	7.4%	4	5.2%	11	6.9%
女性	2	25.0%	0	0.0%	0	0.0%	2	11.1%	0	0.0%	1	5.6%	2	8.7%	0	0.0%	7	4.4%
男女合計	3	23.1%	0	0.0%	1	8.3%	3	9.1%	0	0.0%	3	8.1%	4	8.0%	4	2.9%	18	5.6%
無回答																		
男性	0	0.0%	0	0.0%	0	0.0%	0	0.0%	0	0.0%	0	0.0%	0	0.0%	0	0.0%	0	0.0%
女性	0	0.0%	0	0.0%	1	16.7%	1	5.6%	0	0.0%	0	0.0%	0	0.0%	3	4.8%	5	3.1%
男女合計	0	0.0%	0	0.0%	1	8.3%	1	3.0%	0	0.0%	0	0.0%	0	0.0%	3	2.1%	5	1.6%
全体(人)																		
男性	5		2		6		15		9		19		27		77		160	
女性	8		6		6		18		17		18		23		63		159	
男女合計	13		8		12		33		26		37		50		140		319	

いわき

	10	割合	20	割合	30	割合	40	割合	50	割合	64	割合	69	割合	70～	割合	全体数	割合
1と回答																		
男性	2	10.5%	10	43.5%	20	39.2%	31	51.7%	28	41.2%	19	54.3%	11	28.9%	39	28.5%	160	37.1%
女性	4	26.7%	11	35.5%	26	57.8%	31	50.8%	35	55.6%	13	31.7%	16	32.7%	53	33.8%	189	40.9%
男女合計	6	17.6%	21	38.9%	46	47.9%	62	51.2%	63	48.1%	32	42.1%	27	31.0%	92	31.3%	349	39.1%
2と回答																		
男性	14	73.7%	10	43.5%	29	56.9%	25	41.7%	39	57.4%	15	42.9%	25	65.8%	86	62.8%	243	56.4%
女性	11	73.3%	20	64.5%	15	33.3%	25	41.0%	28	44.4%	26	63.4%	31	63.3%	93	59.2%	249	53.9%
男女合計	25	73.5%	30	55.6%	44	45.8%	50	41.3%	67	51.1%	41	53.9%	56	64.4%	179	60.9%	492	55.1%
3と回答																		
男性	3	15.8%	3	13.0%	2	3.9%	3	5.0%	1	1.5%	1	2.9%	2	5.3%	10	7.3%	25	5.8%
女性	0	0.0%	0	0.0%	4	8.9%	5	8.2%	0	0.0%	2	4.9%	2	4.1%	8	5.1%	21	4.5%
男女合計	3	8.8%	3	5.6%	6	6.3%	8	6.6%	1	0.8%	3	3.9%	4	4.6%	18	6.1%	46	5.2%
無回答																		
男性	0	0.0%	0	0.0%	0	0.0%	1	1.7%	0	0.0%	0	0.0%	0	0.0%	2	1.5%	3	0.7%
女性	0	0.0%	0	0.0%	0	0.0%	0	0.0%	0	0.0%	0	0.0%	0	0.0%	3	1.9%	3	0.6%
男女合計	0	0.0%	0	0.0%	0	0.0%	1	0.8%	0	0.0%	0	0.0%	0	0.0%	5	1.7%	6	0.7%
全体(人)																		
男性	19		23		51		60		68		35		38		137		431	
女性	15		31		45		61		63		41		49		157		462	
男女合計	34		54		96		121		131		76		87		294		893	

全県 (60歳以上・再掲)

	64	割合	69	割合	70	割合	80	割合	90	割合	全体数	割合
1と回答												
男性	101	38.4%	87	30.5%	159	32.0%	94	34.7%	8	21.1%	449	33.2%
女性	105	40.4%	104	34.0%	181	35.6%	126	39.0%	22	26.5%	538	36.3%
男女合計	206	39.4%	191	32.3%	340	33.8%	220	37.0%	30	24.8%	987	34.8%
2と回答												
男性	152	57.8%	175	61.4%	301	60.6%	145	53.5%	22	57.9%	795	58.7%
女性	144	55.4%	177	57.8%	287	56.4%	156	48.3%	40	48.2%	804	54.3%
男女合計	296	56.6%	352	59.6%	588	58.4%	301	50.7%	62	51.2%	1599	56.4%
3と回答												
男性	10	3.8%	19	6.7%	29	5.8%	20	7.4%	7	18.4%	85	6.3%
女性	8	3.1%	18	5.9%	29	5.7%	21	6.5%	17	20.5%	93	6.3%
男女合計	18	3.4%	37	6.3%	58	5.8%	41	6.9%	24	19.8%	178	6.3%
無回答												
男性	0	0.0%	4	1.4%	8	1.6%	12	4.4%	1	2.6%	25	1.8%
女性	3	1.2%	7	2.3%	12	2.4%	20	6.2%	4	4.8%	46	3.1%
男女合計	3	0.6%	11	1.9%	20	2.0%	32	5.4%	5	4.1%	71	2.5%
全体(人)												
男性	263		285		497		271		38		1354	
女性	260		306		509		323		83		1481	
男女合計	523		591		1006		594		121		2835	

22 健康づくりのために必要と考えること（調査票 問22）

問22 あなたは、健康づくりのために何が必要だと考えていますか。
（記述式 自由回答）

調査回答者5,467人中3,173人から回答があった。

	全 体	男 性	女 性
問22回答者数	3,173 (58.0%)	1,479 (55.7%)	1,694 (60.3%)
調査回答者数	5,467	2,656	2,811

- 1 「食生活（栄養バランス）」が必要と回答した人
（他の分野（「運動」、「休養、こころの健康」等）との重複回答を含む。集計は、問22の回答者3,173人に対する割合を示す。以下の集計においても同じ）

	10	割合	20	割合	30	割合	40	割合	50	割合	64	割合	69	割合	70	割合	80	割合	90	割合	全体数	割合
男 性	29	45.3%	50	59.5%	62	44.9%	63	29.7%	84	40.4%	67	43.5%	75	43.4%	107	39.5%	60	37.5%	10	66.7%	607	41.0%
女 性	39	54.9%	51	51.0%	90	57.3%	91	41.6%	138	46.6%	86	53.4%	103	50.7%	171	55.9%	91	57.2%	10	45.5%	870	51.4%
男女合計	68	50.4%	101	54.9%	152	51.5%	154	35.7%	222	44.0%	153	48.6%	178	47.3%	278	48.2%	151	47.3%	20	54.1%	1477	46.5%
全体(人)																						
男 性	64		84		138		212		208		154		173		271		160		15		1479	
女 性	71		100		157		219		296		161		203		306		159		22		1694	
男女合計	135		184		295		431		504		315		376		577		319		37		3173	

- 2 「運動（スポーツ、ウォーキング等）」が必要と回答した人

	10	割合	20	割合	30	割合	40	割合	50	割合	64	割合	69	割合	70	割合	80	割合	90	割合	全体数	割合
男 性	44	68.8%	53	63.1%	95	68.8%	124	58.5%	135	64.9%	100	64.9%	116	67.1%	204	75.3%	105	65.6%	13	86.7%	989	66.9%
女 性	38	53.5%	59	59.0%	105	66.9%	139	63.5%	199	67.2%	118	73.3%	149	73.4%	227	74.2%	112	70.4%	13	59.1%	1159	68.4%
男女合計	82	60.7%	112	60.9%	200	67.8%	263	61.0%	334	66.3%	218	69.2%	265	70.5%	431	74.7%	217	68.0%	26	70.3%	2148	67.7%
全体(人)																						
男 性	64		84		138		212		208		154		173		271		160		15		1479	
女 性	71		100		157		219		296		161		203		306		159		22		1694	
男女合計	135		184		295		431		504		315		376		577		319		37		3173	

- 3 「休養、こころの健康（睡眠、ストレス解消等）」が必要と回答した人

	10	割合	20	割合	30	割合	40	割合	50	割合	64	割合	69	割合	70	割合	80	割合	90	割合	全体数	割合
男 性	20	31.3%	39	46.4%	54	39.1%	71	33.5%	61	29.3%	38	24.7%	32	18.5%	50	18.5%	24	15.0%	3	20.0%	392	26.5%
女 性	37	52.1%	47	47.0%	70	44.6%	109	49.8%	107	36.1%	50	31.1%	68	33.5%	71	23.2%	19	11.9%	1	4.5%	579	34.2%
男女合計	57	42.2%	86	46.7%	124	42.0%	180	41.8%	168	33.3%	88	27.9%	100	26.6%	121	21.0%	43	13.5%	4	10.8%	971	30.6%
全体(人)																						
男 性	64		84		138		212		208		154		173		271		160		15		1479	
女 性	71		100		157		219		296		161		203		306		159		22		1694	
男女合計	135		184		295		431		504		315		376		577		319		37		3173	

- 4 「規則正しい生活習慣」が必要と回答した人

	10	割合	20	割合	30	割合	40	割合	50	割合	64	割合	69	割合	70	割合	80	割合	90	割合	全体数	割合
男 性	6	9.4%	8	9.5%	8	5.8%	11	5.2%	5	2.4%	8	5.2%	11	6.4%	19	7.0%	12	7.5%	1	6.7%	89	6.0%
女 性	6	8.5%	4	4.0%	10	6.4%	12	5.5%	19	6.4%	14	8.7%	7	3.4%	20	6.5%	6	3.8%	1	4.5%	99	5.8%
男女合計	12	8.9%	12	6.5%	18	6.1%	23	5.3%	24	4.8%	22	7.0%	18	4.8%	39	6.8%	18	5.6%	2	5.4%	188	5.9%
全体(人)																						
男 性	64		84		138		212		208		154		173		271		160		15		1479	
女 性	71		100		157		219		296		161		203		306		159		22		1694	
男女合計	135		184		295		431		504		315		376		577		319		37		3173	

5 「検査・健診」が必要と回答した人

	10	割合	20	割合	30	割合	40	割合	50	割合	64	割合	69	割合	70	割合	80	割合	90	割合	全体数	割合
男性	0	0.0%	0	0.0%	2	1.4%	4	1.9%	4	1.9%	5	3.2%	9	5.2%	8	3.0%	5	3.1%	0	0.0%	37	2.5%
女性	0	0.0%	0	0.0%	8	5.1%	6	2.7%	8	2.7%	2	1.2%	5	2.5%	10	3.3%	1	0.6%	1	4.5%	41	2.4%
男女合計	0	0.0%	0	0.0%	10	3.4%	10	2.3%	12	2.4%	7	2.2%	14	3.7%	18	3.1%	6	1.9%	1	2.7%	78	2.5%
全体(人)																						
男性	64		84		138		212		208		154		173		271		160		15		1479	
女性	71		100		157		219		296		161		203		306		159		22		1694	
男女合計	135		184		295		431		504		315		376		577		319		37		3173	

6 「禁煙」が必要と回答した人

	10	割合	20	割合	30	割合	40	割合	50	割合	64	割合	69	割合	70	割合	80	割合	90	割合	全体数	割合
男性	1	1.6%	1	1.2%	2	1.4%	6	2.8%	8	3.8%	5	3.2%	4	2.3%	9	3.3%	1	0.6%	0	0.0%	37	2.5%
女性	0	0.0%	0	0.0%	2	1.3%	0	0.0%	2	0.7%	2	1.2%	1	0.5%	1	0.3%	1	0.6%	0	0.0%	9	0.5%
男女合計	1	0.7%	1	0.5%	4	1.4%	6	1.4%	10	2.0%	7	2.2%	5	1.3%	10	1.7%	2	0.6%	0	0.0%	46	1.4%
全体(人)																						
男性	64		84		138		212		208		154		173		271		160		15		1479	
女性	71		100		157		219		296		161		203		306		159		22		1694	
男女合計	135		184		295		431		504		315		376		577		319		37		3173	

7 「その他」が必要と回答した人

	10	割合	20	割合	30	割合	40	割合	50	割合	64	割合	69	割合	70	割合	80	割合	90	割合	全体数	割合
男性	9	14.1%	14	16.7%	29	21.0%	59	27.8%	45	21.6%	52	33.8%	48	27.7%	81	29.9%	54	33.8%	2	13.3%	393	26.6%
女性	12	16.9%	20	20.0%	48	30.6%	57	26.0%	81	27.4%	55	34.2%	73	36.0%	105	34.3%	52	32.7%	8	36.4%	511	30.2%
男女合計	21	15.6%	34	18.5%	77	26.1%	116	26.9%	126	25.0%	107	34.0%	121	32.2%	186	32.2%	106	33.2%	10	27.0%	904	28.5%
全体(人)																						
男性	64		84		138		212		208		154		173		271		160		15		1479	
女性	71		100		157		219		296		161		203		306		159		22		1694	
男女合計	135		184		295		431		504		315		376		577		319		37		3173	

23 自由回答（調査票 問23）

問23 全体をとおして気づかれた点について、御自由にお書きください。
（記述式 自由回答）

調査回答者5,467人中1,064人から回答があった。

	全体	男性	女性
問23回答者数	1,064 (19.5%)	463 (17.4%)	601 (21.4%)
調査回答者数	5,467	2,656	2,811

第3章 前回調査結果との比較 (満15歳以上対象)

1 健康についての意識 (調査票 問1の集計結果)

あなたは、ふだん自分で健康だと思われますか。

	全 体	男 性	女 性
1 非常に健康だと思う	476 (8.7%)	238 (9.0%)	238 (8.5%)
2 まあ健康な方だと思う	3,686 (67.4%)	1,750 (65.9%)	1,936 (68.9%)
3 あまり健康ではない	937 (17.1%)	484 (18.2%)	453 (16.1%)
4 健康ではない	325 (5.9%)	163 (6.1%)	162 (5.8%)
5 無回答	43 (0.8%)	21 (0.8%)	22 (0.8%)
合 計	5,467	2,656	2,811

【平成30年度健康ふくしま21調査】

	全 体	男 性	女 性
1 非常に健康だと思う	336 (8.3%)	191 (9.6%)	145 (7.0%)
2 まあ健康な方だと思う	2,665 (65.5%)	1,271 (63.9%)	1,394 (67.1%)
3 あまり健康ではない	664 (16.3%)	331 (16.6%)	333 (16.0%)
4 健康ではない	267 (6.6%)	128 (6.4%)	139 (6.7%)
5 無回答	134 (3.3%)	67 (3.4%)	67 (3.2%)
合 計	4,066	1,988	2,078

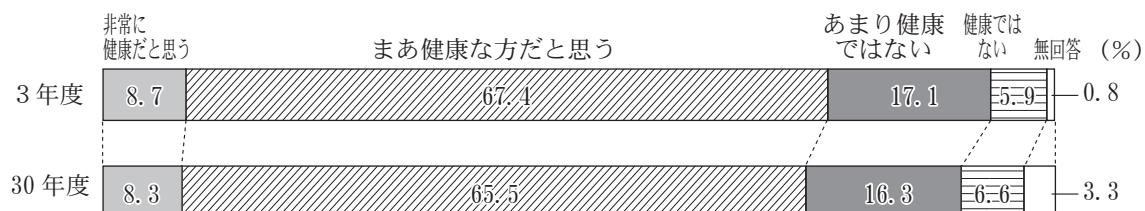

2 健康づくりのために気をつけていること（調査票 問2の集計結果）

あなたは、健康づくりのためにどのようなことに気をつけていますか。（複数回答有）

【回答者数】 5,467人（男性2,656人、女性2,811人）

	全 体	男 性	女 性
1 食生活に気をつけている	3,001 (54.9%)	1,330 (50.1%)	1,671 (59.4%)
2 歩いたり軽い体操をしている	2,137 (39.1%)	1,023 (38.5%)	1,114 (39.6%)
3 スポーツやランニングをしている	648 (11.9%)	425 (16.0%)	223 (7.9%)
4 休養や睡眠を十分とるようにしている	2,541 (46.5%)	1,192 (44.9%)	1,349 (48.0%)
5 酒を控えるようにしている	1,497 (27.4%)	780 (29.4%)	717 (25.5%)
6 たばこを吸わないようにしている	2,026 (37.1%)	1,085 (40.9%)	941 (33.5%)
7 定期的に健康診断を受けるようにしている	2,455 (44.9%)	1,199 (45.1%)	1,256 (44.7%)
8 趣味や生きがいをもち、生活にメリハリを持たせるようにしている	1,611 (29.5%)	749 (28.2%)	862 (30.7%)
9 健康補助食品などを利用している	996 (18.2%)	380 (14.3%)	616 (21.9%)
10 その他	129 (2.4%)	64 (2.4%)	65 (2.3%)
11 特に何もしていない	588 (10.8%)	297 (11.2%)	291 (10.4%)

【平成30年度健康ふくしま21調査】

【回答者数】 4,066人（男性1,988人、女性2,078人）

	全 体	男 性	女 性
1 食生活に気をつけている	2,314 (56.9%)	1,012 (50.9%)	1,302 (62.7%)
2 歩いたり軽い体操をしている	1,442 (35.5%)	669 (33.7%)	773 (37.2%)
3 スポーツやランニングをしている	506 (12.4%)	315 (15.8%)	191 (9.2%)
4 休養や睡眠を十分とるようにしている	1,824 (44.9%)	822 (41.3%)	1,002 (48.2%)
5 酒を控えるようにしている	944 (23.2%)	473 (23.8%)	471 (22.7%)
6 たばこを吸わないようにしている	1,358 (33.4%)	741 (37.3%)	617 (29.7%)
7 定期的に健康診断を受けるようにしている	1,718 (42.3%)	838 (42.2%)	880 (42.3%)
8 趣味や生きがいをもち、生活にメリハリを持たせるようにしている	1,186 (29.2%)	528 (26.6%)	658 (31.7%)
9 健康補助食品などを利用している	708 (17.4%)	289 (14.5%)	419 (20.2%)
10 その他	121 (3.0%)	52 (2.6%)	69 (3.3%)
11 特に何もしていない	418 (10.3%)	210 (10.6%)	208 (10.0%)

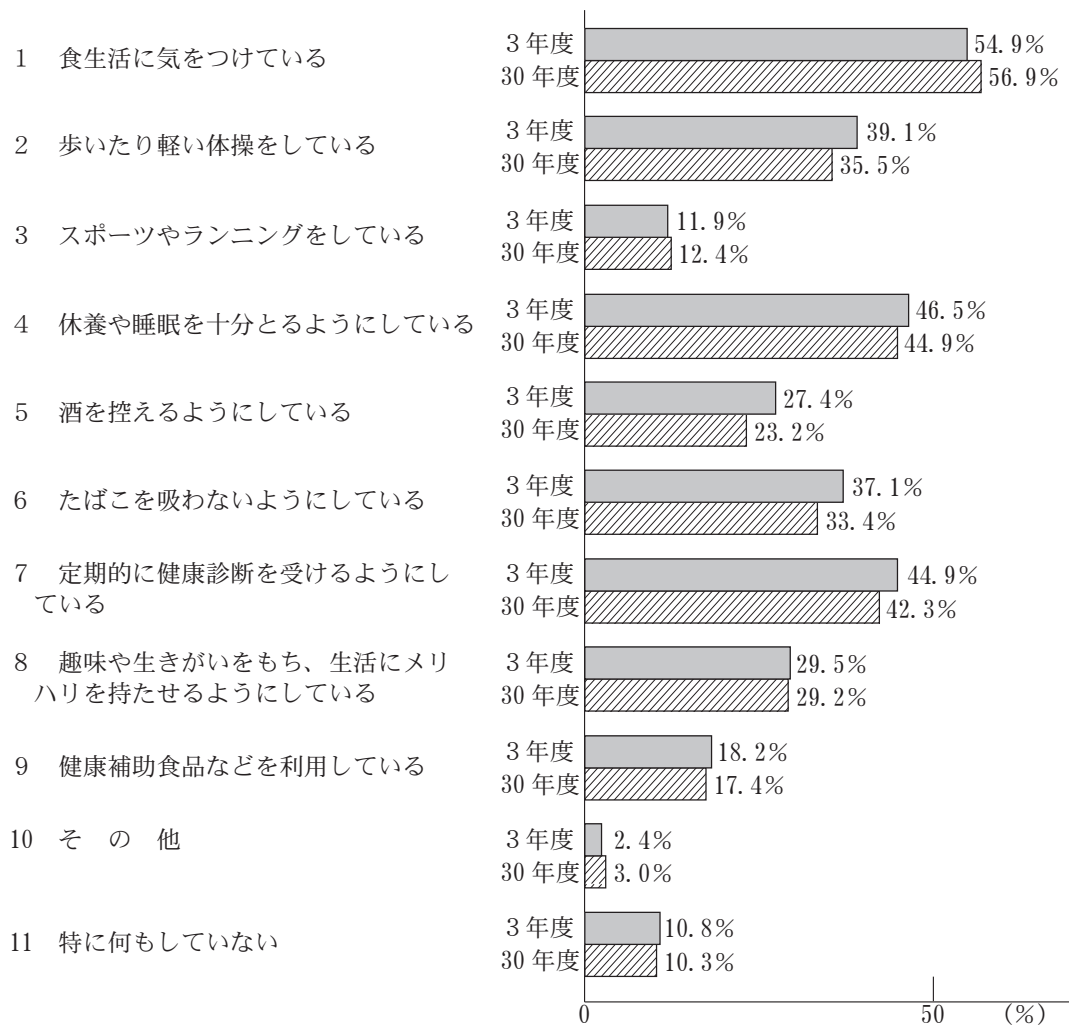

3 「県民健康の日」の認知度（調査票 問3の集計結果）

あなたは、福島県において、10月10日が「県民健康の日」であることを知っていますか。			
	全体	男性	女性
1 知っている	1,328 (24.3%)	611 (23.0%)	717 (25.5%)
2 知らない	4,099 (75.0%)	2,037 (76.7%)	2,062 (73.4%)
3 無回答	40 (0.7%)	8 (0.3%)	32 (1.1%)
合計	5,467	2,656	2,811

【平成30年度健康ふくしま21調査】			
	全体	男性	女性
1 知っている	801 (19.7%)	357 (18.0%)	444 (21.4%)
2 知らない	3,151 (77.5%)	1,579 (79.4%)	1,572 (75.6%)
3 無回答	114 (2.8%)	52 (2.6%)	62 (3.0%)
合計	4,066	1,988	2,078

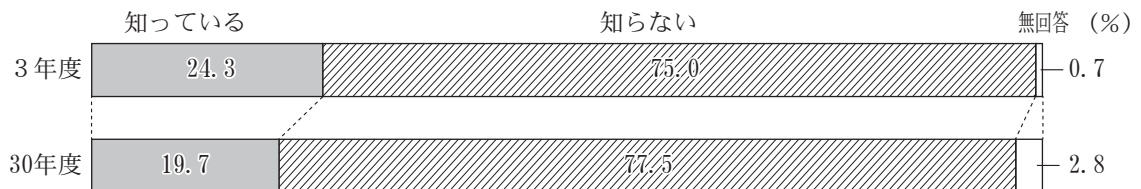

4 食生活（朝食）の状況（調査票 問4の集計結果）

あなたは、朝食をだいたい毎日とっていますか。

	全体	男性	女性
1 はい	4,659 (85.2%)	2,194 (82.6%)	2,465 (87.7%)
2 いいえ	764 (14.0%)	438 (16.5%)	326 (11.6%)
無回答	44 (0.8%)	24 (0.9%)	20 (0.7%)
合計	5,467	2,656	2,811

【平成30年度健康ふくしま21調査】

	全体	男性	女性
1 はい	3,465 (85.2%)	1,636 (82.3%)	1,829 (88.0%)
2 いいえ	505 (12.4%)	301 (15.1%)	204 (9.8%)
3 無回答	96 (2.4%)	51 (2.6%)	45 (2.2%)
合計	4,066	1,988	2,078

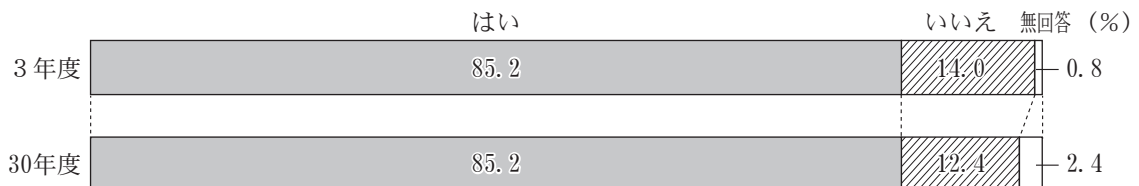

5 食生活（朝食・夕食）の状況（調査票 問5の集計結果）

あなたは、朝食を家族とどのくらい一緒に食べていますか。

	全 体	男 性	女 性
1 ほとんど毎日	2,797 (51.2%)	1,350 (50.8%)	1,447 (51.5%)
2 週に4～5日	259 (4.7%)	124 (4.7%)	135 (4.8%)
3 週に2～3日	380 (7.0%)	176 (6.6%)	204 (7.3%)
4 週に1日程度	231 (4.2%)	122 (4.6%)	109 (3.9%)
5 ほとんどない	1,544 (28.2%)	741 (27.9%)	803 (28.6%)
6 無回答	256 (4.7%)	143 (5.4%)	113 (4.0%)
合 計	5,467	2,656	2,811

【平成30年度健康ふくしま21調査】

	全 体	男 性	女 性
1 ほとんど毎日	2,134 (52.5%)	1,032 (51.9%)	1,102 (53.0%)
2 週に4～5日	181 (4.5%)	97 (4.9%)	84 (4.0%)
3 週に2～3日	271 (6.7%)	135 (6.8%)	136 (6.5%)
4 週に1日程度	229 (5.6%)	121 (6.1%)	108 (5.2%)
5 ほとんどない	1,004 (24.7%)	497 (25.0%)	507 (24.4%)
6 無回答	247 (6.1%)	106 (5.3%)	141 (6.8%)
合 計	4,066	1,988	2,078

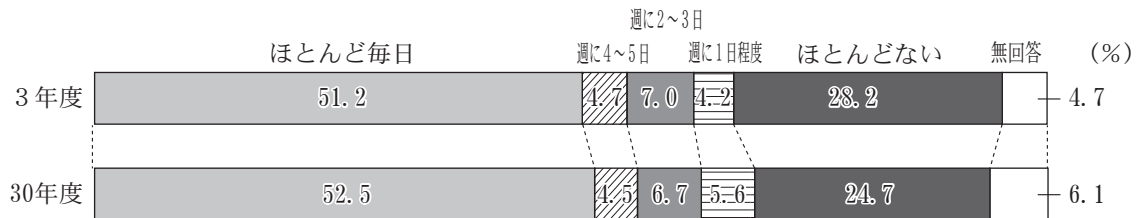

あなたは、夕食を家族とどのくらい一緒に食べていますか。

	全 体	男 性	女 性
1 ほとんど毎日	3,556 (65.0%)	1,662 (62.6%)	1,894 (67.4%)
2 週に4～5日	372 (6.8%)	194 (7.3%)	178 (6.3%)
3 週に2～3日	426 (7.8%)	250 (9.4%)	176 (6.3%)
4 週に1日程度	136 (2.5%)	86 (3.2%)	50 (1.8%)
5 ほとんどない	859 (15.7%)	409 (15.4%)	450 (16.0%)
6 無回答	118 (2.2%)	55 (2.1%)	63 (2.2%)
合 計	5,467	2,656	2,811

【平成30年度健康ふくしま21調査】

	全 体	男 性	女 性
1 ほとんど毎日	2,520 (62.0%)	1,177 (59.2%)	1,343 (64.6%)
2 週に4～5日	276 (6.8%)	155 (7.8%)	121 (5.8%)
3 週に2～3日	349 (8.6%)	206 (10.4%)	143 (6.9%)
4 週に1日程度	134 (3.3%)	82 (4.1%)	52 (2.5%)
5 ほとんどない	543 (13.4%)	259 (13.0%)	284 (13.7%)
6 無回答	244 (6.0%)	109 (5.5%)	135 (6.5%)
合 計	4,066	1,988	2,078

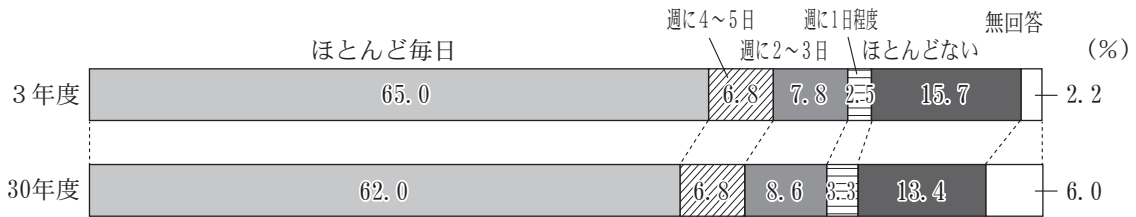

6 「食育推進月間」「食育の日」の認知度 (調査票 問6の集計結果)

あなたは、食育推進月間（6月）と食育の日（毎月19日）を知っていますか。

	全 体	男 性	女 性
1 知っている	234 (4.3%)	86 (3.2%)	148 (5.3%)
2 名称は知っているが、月日までは知らない	981 (17.9%)	349 (13.1%)	632 (22.5%)
3 知らない	4,220 (77.2%)	2,211 (83.2%)	2,009 (71.5%)
4 無回答	32 (0.6%)	10 (0.4%)	22 (0.8%)
合 計	5,467	2,656	2,811

【平成30年度健康ふくしま21調査】

	全 体	男 性	女 性
1 知っている	152 (3.7%)	50 (2.5%)	102 (4.9%)
2 名称は知っているが、月日までは知らない	955 (23.5%)	338 (17.0%)	617 (29.7%)
3 知らない	2,827 (69.5%)	1,540 (77.5%)	1,287 (61.9%)
4 無回答	132 (3.2%)	60 (3.0%)	72 (3.5%)
合 計	4,066	1,988	2,078

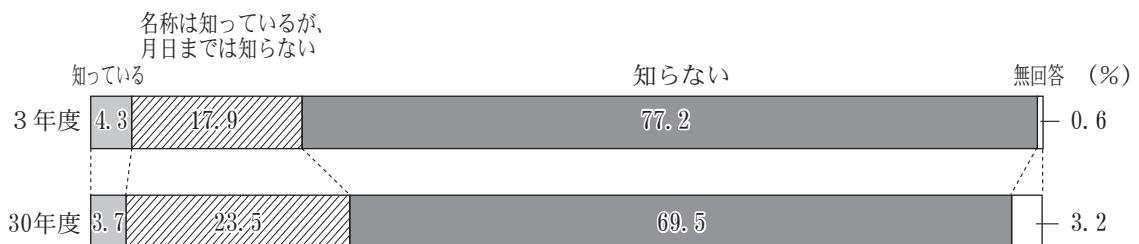

7 食生活（栄養バランス）の状況（調査票 問7の調査結果）

あなたは、日頃から栄養バランスのとれた食生活を実践していますか。

	全体	男性	女性
1 はい	3,383 (61.9%)	1,516 (57.1%)	1,867 (66.4%)
2 いいえ	2,027 (37.1%)	1,122 (42.2%)	905 (32.2%)
3 無回答	57 (1.0%)	18 (0.7%)	39 (1.4%)
合計	5,467	2,656	2,811

【平成30年度健康ふくしま21調査】

	全体	男性	女性
1 はい	2,442 (60.1%)	1,088 (54.7%)	1,354 (65.2%)
2 いいえ	1,485 (36.5%)	834 (42.0%)	651 (31.3%)
3 無回答	139 (3.4%)	66 (3.3%)	73 (3.5%)
合計	4,066	1,988	2,078

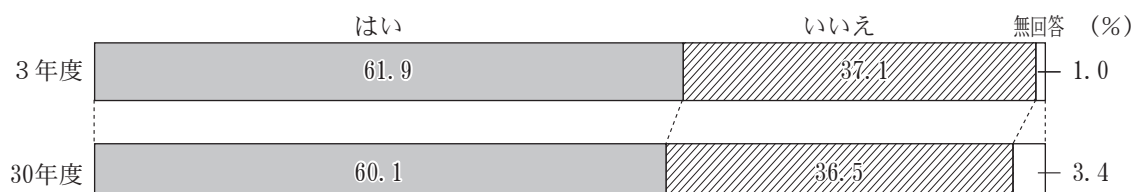

8 「フレイル」の認知度（調査票 問8の調査結果）

あなたは、フレイルを知っていますか。

	全体	男性	女性
1 知っている	905 (16.6%)	306 (11.5%)	599 (21.3%)
2 知らない	4,521 (82.7%)	2,340 (88.1%)	2,181 (77.6%)
3 無回答	41 (0.7%)	10 (0.4%)	31 (1.1%)
合計	5,467	2,656	2,811



9 「ロコモティブシンドローム」の認知度（調査票 問9の調査結果）

あなたは、ロコモティブシンドローム（運動器症候群）を知っていますか。			
	全 体	男 性	女 性
1 知っている	1,297 (23.7%)	430 (16.2%)	867 (30.8%)
2 知らない	4,139 (75.7%)	2,218 (83.5%)	1,921 (68.3%)
3 無回答	31 (0.6%)	8 (0.3%)	23 (0.8%)
合 計	5,467	2,656	2,811

【平成30年度健康ふくしま21調査】			
	全 体	男 性	女 性
1 知っている	947 (23.3%)	325 (16.3%)	622 (29.9%)
2 知らない	2,996 (73.7%)	1,606 (80.8%)	1,390 (66.9%)
3 無回答	123 (3.0%)	57 (2.9%)	66 (3.2%)
合 計	4,066	1,988	2,078

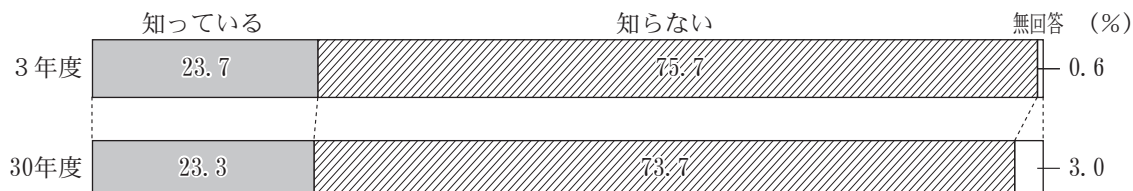

10 最近1年間の運動状況

(1) 最近1年間の運動状況（調査票 問10の調査結果）

最近1年間の運動状況について			
	全 体	男 性	女 性
1 何らかの運動をほとんど毎日している	932 (17.0%)	476 (17.9%)	456 (16.2%)
2 何らかの運動を週2～4回程度している	1,160 (21.2%)	574 (21.6%)	586 (20.8%)
3 何らかの運動を週1回程度している	946 (17.3%)	446 (16.8%)	500 (17.8%)
4 ほとんど（まったく）していない	2,355 (43.1%)	1,136 (42.8%)	1,219 (43.4%)
5 無回答	74 (1.4%)	24 (0.9%)	50 (1.8%)
合 計	5,467	2,656	2,811

【平成30年度健康ふくしま21調査】			
	全 体	男 性	女 性
1 何らかの運動をほとんど毎日している	636 (15.6%)	357 (18.0%)	279 (13.4%)
2 何らかの運動を週2～4回程度している	833 (20.5%)	393 (19.8%)	440 (21.2%)
3 何らかの運動を週1回程度している	700 (17.2%)	343 (17.3%)	357 (17.2%)
4 ほとんど（まったく）していない	1,764 (43.4%)	831 (41.8%)	933 (44.9%)
5 無回答	133 (3.3%)	64 (3.2%)	69 (3.3%)
合 計	4,066	1,988	2,078

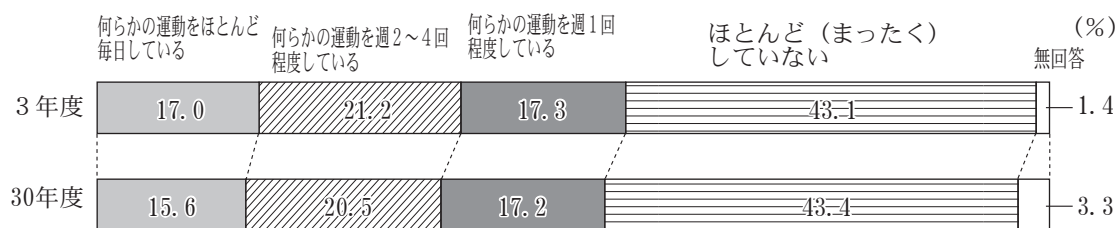

(2) 運動時間 (調査票 問10付問の調査結果)

運動時間について				
	全 体	男 性	女 性	
1 15分未満	642 (21.1%)	244 (16.3%)	398 (25.8%)	
2 15~30分未満	934 (30.7%)	409 (27.3%)	525 (34.0%)	
3 30分以上	1,428 (47.0%)	829 (55.4%)	599 (38.8%)	
4 無回答	34 (1.1%)	14 (0.9%)	20 (1.3%)	
合 計	3,038	1,496	1,542	

【平成30年度健康ふくしま21調査】				
	全 体	男 性	女 性	
1 15分未満	445 (20.5%)	174 (15.9%)	271 (25.2%)	
2 15~30分未満	625 (28.8%)	307 (28.1%)	318 (29.6%)	
3 30分以上	1,065 (49.1%)	594 (54.3%)	471 (43.8%)	
4 無回答	34 (1.6%)	18 (1.6%)	16 (1.5%)	
合 計	2,169	1,093	1,076	

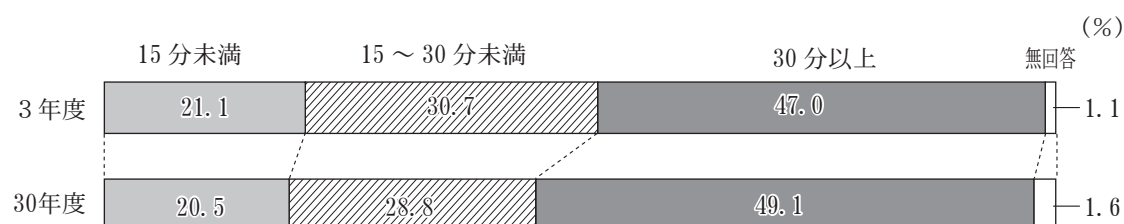

(3) 運動習慣の状況 (満20歳以上対象) (調査票 問10、問10付問の回答に関するクロス集計)

運動習慣について				
	全 体	男 性	女 性	
1 何らかの運動をほとんど毎日、30分以上している				
2 何らかの運動を週2~4回程度、30分以上している				
	1 413 (7.9%)	247 (9.7%)	166 (6.2%)	
	2 519 (9.9%)	301 (11.9%)	218 (8.1%)	
【回答者数】	5,224	2,537	2,687	

【平成30年度健康ふくしま21調査】

- 1 何らかの運動をほとんど毎日、30分以上している
- 2 何らかの運動を週2～4回程度、30分以上している

	全 体	男 性	女 性
1	276 (7.0%)	173 (9.0%)	103 (5.1%)
2	399 (10.2%)	207 (10.8%)	192 (9.6%)
【回答者数】	3,922	1,912	2,010

11 喫煙の状況

(1) 喫煙の有無（満20歳以上対象）（調査票 問11の集計結果）

あなたは、たばこを吸っていますか。

	全 体	男 性	女 性
1 毎日吸う	787 (15.1%)	612 (24.1%)	175 (6.5%)
2 時々吸う	61 (1.2%)	46 (1.8%)	15 (0.6%)
3 今は吸っていない	1,415 (27.1%)	1,102 (43.4%)	313 (11.6%)
4 習慣的に吸ったことがない	2,835 (54.3%)	750 (29.6%)	2,085 (77.6%)
5 無回答	126 (2.4%)	27 (1.1%)	99 (3.7%)
合 計	5,224	2,537	2,687

【平成30年度健康ふくしま21調査】

	全 体	男 性	女 性
1 毎日吸う	634 (16.2%)	502 (26.3%)	132 (6.6%)
2 時々吸う	67 (1.7%)	52 (2.7%)	15 (0.7%)
3 今は吸っていない	984 (25.1%)	768 (40.2%)	216 (10.7%)
4 習慣的に吸ったことがない	2,036 (51.9%)	523 (27.4%)	1,513 (75.3%)
5 無回答	201 (5.1%)	67 (3.5%)	134 (6.7%)
合 計	3,922	1,912	2,010

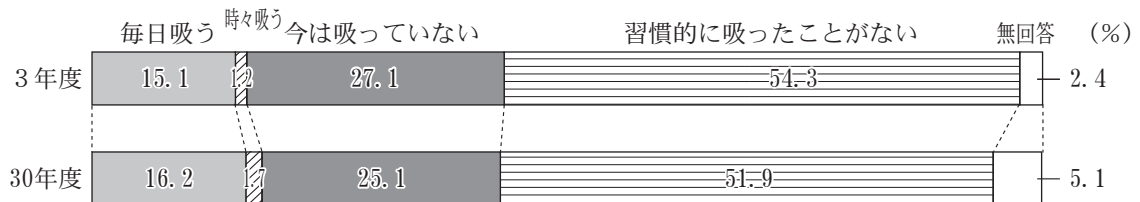

(2) 禁煙の意思（満20歳以上対象）（調査票 問11付問の調査結果）

あなたは、たばこをやめたいと思いますか。

	全 体	男 性	女 性
1 やめたい	194 (22.9%)	131 (19.9%)	63 (33.2%)
2 本数を減らしたい	346 (40.8%)	282 (42.9%)	64 (33.7%)
3 やめたくない	192 (22.6%)	157 (23.9%)	35 (18.4%)
4 わからない	107 (12.6%)	81 (12.3%)	26 (13.7%)
5 無回答	9 (1.1%)	7 (1.1%)	2 (1.1%)
合 計	848	658	190

【平成30年度健康ふくしま21調査】

	全 体	男 性	女 性
1 やめたい	176 (25.1%)	129 (23.3%)	47 (32.0%)
2 本数を減らしたい	237 (33.8%)	203 (36.6%)	34 (23.1%)
3 やめたくない	163 (23.3%)	129 (23.3%)	34 (23.1%)
4 わからない	113 (16.1%)	84 (15.2%)	29 (19.7%)
5 無回答	12 (1.7%)	9 (1.6%)	3 (2.0%)
合 計	701	554	147

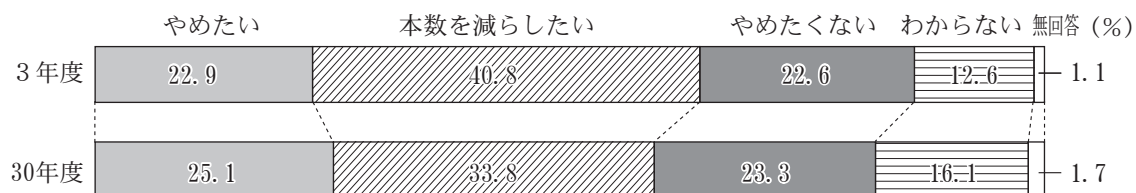

(3) 家族（世帯）の喫煙状況（調査票 問12の集計結果）

あなたの家族で、あなたを含めて、たばこを吸っている方はいますか。

	全体数	割合
1 い る	855世帯	(31.9%)
2 い ない	1,797世帯	(67.1%)
3 無回答	28世帯	(1.0%)
合 計	2,680世帯	

【平成30年度健康ふくしま21調査】

	全体数	割合
1 い る	742世帯	(35.2%)
2 い ない	1,319世帯	(62.7%)
3 無回答	44世帯	(2.1%)
合 計	2,105世帯	

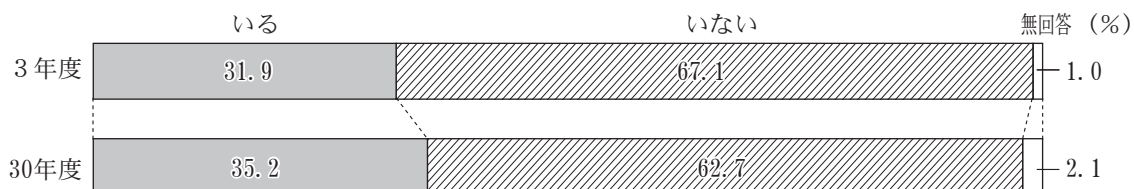

13 受動喫煙の状況 (調査票 問13の集計結果)

あなたは、この1か月間に、自分以外の人が吸っていたたばこの煙を吸う機会（受動喫煙）がありましたか。

○家庭

	全体	男性	女性
1 ほぼ毎日	485 (8.9%)	214 (8.1%)	271 (9.6%)
2 週に数回程度	136 (2.5%)	60 (2.3%)	76 (2.7%)
3 週に1回程度	83 (1.5%)	33 (1.2%)	50 (1.8%)
4 月に1回程度	129 (2.4%)	50 (1.9%)	79 (2.8%)
5 全くなかった	3,384 (61.9%)	1,694 (63.8%)	1,690 (60.1%)
6 いかなかった	426 (7.8%)	186 (7.0%)	240 (8.5%)
7 無回答	824 (15.1%)	419 (15.8%)	405 (14.4%)
合計	5,467	2,656	2,811

【平成30年度健康ふくしま21調査】

	全体	男性	女性
1 ほぼ毎日	402 (9.9%)	160 (8.0%)	242 (11.6%)
2 週に数回程度	114 (2.8%)	48 (2.4%)	66 (3.2%)
3 週に1回程度	85 (2.1%)	29 (1.5%)	56 (2.7%)
4 月に1回程度	91 (2.2%)	37 (1.9%)	54 (2.6%)
5 全くなかった	1,929 (47.4%)	977 (49.1%)	952 (45.8%)
6 いかなかった	618 (15.2%)	308 (15.5%)	310 (14.9%)
7 無回答	827 (20.3%)	429 (21.6%)	398 (19.2%)
合計	4,066	1,988	2,078

○職場

	全体	男性	女性
1 ほぼ毎日	410 (7.5%)	327 (12.3%)	83 (3.0%)
2 週に数回程度	245 (4.5%)	169 (6.4%)	76 (2.7%)
3 週に1回程度	105 (1.9%)	73 (2.7%)	32 (1.1%)
4 月に1回程度	118 (2.2%)	73 (2.7%)	45 (1.6%)
5 全くなかった	2,089 (38.2%)	939 (35.4%)	1,150 (40.9%)
6 いかなかった	1,235 (22.6%)	525 (19.8%)	710 (25.3%)
7 無回答	1,265 (23.1%)	550 (20.7%)	715 (25.4%)
合計	5,467	2,656	2,811

【平成30年度健康ふくしま21調査】

	全 体	男 性	女 性
1 ほぼ毎日	447 (11.0%)	346 (17.4%)	101 (4.9%)
2 週に数回程度	225 (5.5%)	164 (8.2%)	61 (2.9%)
3 週に1回程度	113 (2.8%)	72 (3.6%)	41 (2.0%)
4 月に1回程度	116 (2.9%)	75 (3.8%)	41 (2.0%)
5 全くなかった	993 (24.4%)	428 (21.5%)	565 (27.2%)
6 いかなかった	931 (22.9%)	370 (18.6%)	561 (27.0%)
7 無回答	1,241 (30.5%)	533 (26.8%)	708 (34.1%)
合 計	4,066	1,988	2,078

○学 校

	全 体	男 性	女 性
1 ほぼ毎日	3 (0.1%)	1 (0.0%)	2 (0.1%)
2 週に数回程度	7 (0.1%)	6 (0.2%)	1 (0.0%)
3 週に1回程度	11 (0.2%)	9 (0.3%)	2 (0.1%)
4 月に1回程度	8 (0.1%)	5 (0.2%)	3 (0.1%)
5 全くなかった	1,287 (23.5%)	601 (22.6%)	686 (24.4%)
6 いかなかった	2,377 (43.5%)	1,170 (44.1%)	1,207 (42.9%)
7 無回答	1,774 (32.4%)	864 (32.5%)	910 (32.4%)
合 計	5,467	2,656	2,811

【平成30年度健康ふくしま21調査】

	全 体	男 性	女 性
1 ほぼ毎日	12 (0.3%)	7 (0.4%)	5 (0.2%)
2 週に数回程度	11 (0.3%)	6 (0.3%)	5 (0.2%)
3 週に1回程度	11 (0.3%)	6 (0.3%)	5 (0.2%)
4 月に1回程度	16 (0.4%)	7 (0.4%)	9 (0.4%)
5 全くなかった	667 (16.4%)	318 (16.0%)	349 (16.8%)
6 いかなかった	1,641 (40.4%)	799 (40.2%)	842 (40.5%)
7 無回答	1,708 (42.0%)	845 (42.5%)	863 (41.5%)
合 計	4,066	1,988	2,078

○飲食店

	全 体	男 性	女 性
1 ほぼ毎日	17 (0.3%)	12 (0.5%)	5 (0.2%)
2 週に数回程度	23 (0.4%)	18 (0.7%)	5 (0.2%)
3 週に1回程度	57 (1.0%)	32 (1.2%)	25 (0.9%)
4 月に1回程度	157 (2.9%)	92 (3.5%)	65 (2.3%)
5 全くなかった	1,977 (36.2%)	974 (36.7%)	1,003 (35.7%)
6 いかなかった	1,826 (33.4%)	863 (32.5%)	963 (34.3%)
7 無回答	1,410 (25.8%)	665 (25.0%)	745 (26.5%)
合 計	5,467	2,656	2,811

【平成30年度健康ふくしま21調査】

	全 体	男 性	女 性
1 ほぼ毎日	42 (1.0%)	25 (1.3%)	17 (0.8%)
2 週に数回程度	119 (2.9%)	83 (4.2%)	36 (1.7%)
3 週に1回程度	179 (4.4%)	122 (6.1%)	57 (2.7%)
4 月に1回程度	552 (13.6%)	295 (14.8%)	257 (12.4%)
5 全くなかった	1,082 (26.6%)	483 (24.3%)	599 (28.8%)
6 いかなかった	811 (19.9%)	378 (19.0%)	433 (20.8%)
7 無回答	1,281 (31.5%)	602 (30.3%)	679 (32.7%)
合 計	4,066	1,988	2,078

○遊技場

	全 体	男 性	女 性
1 ほぼ毎日	17 (0.3%)	13 (0.5%)	4 (0.1%)
2 週に数回程度	36 (0.7%)	34 (1.3%)	2 (0.1%)
3 週に1回程度	49 (0.9%)	42 (1.6%)	7 (0.2%)
4 月に1回程度	62 (1.1%)	42 (1.6%)	20 (0.7%)
5 全くなかった	1,142 (20.9%)	574 (21.6%)	568 (20.2%)
6 いかなかった	2,673 (48.9%)	1,248 (47.0%)	1,425 (50.7%)
7 無回答	1,488 (27.2%)	703 (26.5%)	785 (27.9%)
合 計	5,467	2,656	2,811

【平成30年度健康ふくしま21調査】

	全 体	男 性	女 性
1 ほぼ毎日	40 (1.0%)	31 (1.6%)	9 (0.4%)
2 週に数回程度	96 (2.4%)	78 (3.9%)	18 (0.9%)
3 週に1回程度	122 (3.0%)	94 (4.7%)	28 (1.3%)
4 月に1回程度	154 (3.8%)	102 (5.1%)	52 (2.5%)
5 全くなかった	547 (13.5%)	253 (12.7%)	294 (14.1%)
6 いかなかった	1,667 (41.0%)	764 (38.4%)	903 (43.5%)
7 無回答	1,440 (35.4%)	666 (33.5%)	774 (37.2%)
合 計	4,066	1,988	2,078

○行政機関

	全 体	男 性	女 性
1 ほぼ毎日	3 (0.1%)	1 (0.0%)	2 (0.1%)
2 週に数回程度	5 (0.1%)	5 (0.2%)	0 (0.0%)
3 週に1回程度	10 (0.2%)	6 (0.2%)	4 (0.1%)
4 月に1回程度	41 (0.7%)	21 (0.8%)	20 (0.7%)
5 全くなかった	1,727 (31.6%)	870 (32.8%)	857 (30.5%)
6 いかなかった	2,194 (40.1%)	1,038 (39.1%)	1,156 (41.1%)
7 無回答	1,487 (27.2%)	715 (26.9%)	772 (27.5%)
合 計	5,467	2,656	2,811

【平成30年度健康ふくしま21調査】

	全 体	男 性	女 性
1 ほぼ毎日	16 (0.4%)	10 (0.5%)	6 (0.3%)
2 週に数回程度	15 (0.4%)	14 (0.7%)	1 (0.0%)
3 週に1回程度	10 (0.2%)	5 (0.3%)	5 (0.2%)
4 月に1回程度	82 (2.0%)	48 (2.4%)	34 (1.6%)
5 全くなかった	989 (24.3%)	487 (24.5%)	502 (24.2%)
6 いかなかった	1,491 (36.7%)	723 (36.4%)	768 (37.0%)
7 無回答	1,463 (36.0%)	701 (35.3%)	762 (36.7%)
合 計	4,066	1,988	2,078

○医療機関

	全 体	男 性	女 性
1 ほぼ毎日	5 (0.1%)	3 (0.1%)	2 (0.1%)
2 週に数回程度	11 (0.2%)	5 (0.2%)	6 (0.2%)
3 週に1回程度	12 (0.2%)	6 (0.2%)	6 (0.2%)
4 月に1回程度	129 (2.4%)	76 (2.9%)	53 (1.9%)
5 全くなかった	2,587 (47.3%)	1,230 (46.3%)	1,357 (48.3%)
6 いかなかった	1,297 (23.7%)	648 (24.4%)	649 (23.1%)
7 無回答	1,426 (26.1%)	688 (25.9%)	738 (26.3%)
合 計	5,467	2,656	2,811

【平成30年度健康ふくしま21調査】

	全 体	男 性	女 性
1 ほぼ毎日	12 (0.3%)	9 (0.5%)	3 (0.1%)
2 週に数回程度	13 (0.3%)	9 (0.5%)	4 (0.2%)
3 週に1回程度	9 (0.2%)	3 (0.2%)	6 (0.3%)
4 月に1回程度	65 (1.6%)	43 (2.2%)	22 (1.1%)
5 全くなかった	1,396 (34.3%)	650 (32.7%)	746 (35.9%)
6 いかなかった	1,145 (28.2%)	580 (29.2%)	565 (27.2%)
7 無回答	1,426 (35.1%)	694 (34.9%)	732 (35.2%)
合 計	4,066	1,988	2,078

○公共交通機関

	全 体	男 性	女 性
1 ほぼ毎日	5 (0.1%)	3 (0.1%)	2 (0.1%)
2 週に数回程度	14 (0.3%)	11 (0.4%)	3 (0.1%)
3 週に1回程度	12 (0.2%)	5 (0.2%)	7 (0.2%)
4 月に1回程度	50 (0.9%)	24 (0.9%)	26 (0.9%)
5 全くなかった	1,668 (30.5%)	829 (31.2%)	839 (29.8%)
6 いかなかった	2,225 (40.7%)	1,064 (40.1%)	1,161 (41.3%)
7 無回答	1,493 (27.3%)	720 (27.1%)	773 (27.5%)
合 計	5,467	2,656	2,811

【平成30年度健康ふくしま21調査】

	全 体	男 性	女 性
1 ほぼ毎日	14 (0.3%)	11 (0.6%)	3 (0.1%)
2 週に数回程度	19 (0.5%)	13 (0.7%)	6 (0.3%)
3 週に1回程度	27 (0.7%)	18 (0.9%)	9 (0.4%)
4 月に1回程度	106 (2.6%)	66 (3.3%)	40 (1.9%)
5 全くなかった	1,159 (28.5%)	557 (28.0%)	602 (29.0%)
6 いかなかった	1,301 (32.0%)	637 (32.0%)	664 (32.0%)
7 無回答	1,440 (35.4%)	686 (34.5%)	754 (36.3%)
合 計	4,066	1,988	2,078

○路 上

	全 体	男 性	女 性
1 ほぼ毎日	40 (0.7%)	23 (0.9%)	17 (0.6%)
2 週に数回程度	84 (1.5%)	54 (2.0%)	30 (1.1%)
3 週に1回程度	109 (2.0%)	64 (2.4%)	45 (1.6%)
4 月に1回程度	315 (5.8%)	144 (5.4%)	171 (6.1%)
5 全くなかった	2,704 (49.5%)	1,334 (50.2%)	1,370 (48.7%)
6 いかなかった	844 (15.4%)	385 (14.5%)	459 (16.3%)
7 無回答	1,371 (25.1%)	652 (24.5%)	719 (25.6%)
合 計	5,467	2,656	2,811

【平成30年度健康ふくしま21調査】

	全 体	男 性	女 性
1 ほぼ毎日	53 (1.3%)	28 (1.4%)	25 (1.2%)
2 週に数回程度	155 (3.8%)	89 (4.5%)	66 (3.2%)
3 週に1回程度	171 (4.2%)	100 (5.0%)	71 (3.4%)
4 月に1回程度	372 (9.1%)	188 (9.5%)	184 (8.9%)
5 全くなかった	1,339 (32.9%)	647 (32.5%)	692 (33.3%)
6 いかなかった	640 (15.7%)	298 (15.0%)	342 (16.5%)
7 無回答	1,336 (32.9%)	638 (32.1%)	698 (33.6%)
合 計	4,066	1,988	2,078

○子供が利用する屋外の空間

	全 体	男 性	女 性
1 ほぼ毎日	10 (0.2%)	7 (0.3%)	3 (0.1%)
2 週に数回程度	10 (0.2%)	7 (0.3%)	3 (0.1%)
3 週に1回程度	13 (0.2%)	5 (0.2%)	8 (0.3%)
4 月に1回程度	42 (0.8%)	22 (0.8%)	20 (0.7%)
5 全くなかった	1,574 (28.8%)	789 (29.7%)	785 (27.9%)
6 いかなかった	2,228 (40.8%)	1,063 (40.0%)	1,165 (41.4%)
7 無回答	1,590 (29.1%)	763 (28.7%)	827 (29.4%)
合 計	5,467	2,656	2,811

【平成30年度健康ふくしま21調査】			
	全 体	男 性	女 性
1 ほぼ毎日	15 (0.4%)	7 (0.4%)	8 (0.4%)
2 週に数回程度	19 (0.5%)	14 (0.7%)	5 (0.2%)
3 週に1回程度	22 (0.5%)	12 (0.6%)	10 (0.5%)
4 月に1回程度	58 (1.4%)	28 (1.4%)	30 (1.4%)
5 全くなかった	904 (22.2%)	447 (22.5%)	457 (22.0%)
6 いかなかった	1,512 (37.2%)	745 (37.5%)	767 (36.9%)
7 無回答	1,536 (37.8%)	735 (37.0%)	801 (38.5%)
合 計	4,066	1,988	2,078

○健康増進施設

	全 体	男 性	女 性
1 ほぼ毎日	3 (0.1%)	3 (0.1%)	0 (0.0%)
2 週に数回程度	10 (0.2%)	7 (0.3%)	3 (0.1%)
3 週に1回程度	13 (0.2%)	11 (0.4%)	2 (0.1%)
4 月に1回程度	15 (0.3%)	8 (0.3%)	7 (0.2%)
5 全くなかった	1,332 (24.4%)	647 (24.4%)	685 (24.4%)
6 いかなかった	2,480 (45.4%)	1,200 (45.2%)	1,280 (45.5%)
7 無回答	1,614 (29.5%)	780 (29.4%)	834 (29.7%)
合 計	5,467	2,656	2,811

【平成30年度健康ふくしま21調査】			
	全 体	男 性	女 性
1 ほぼ毎日	6 (0.1%)	3 (0.2%)	3 (0.1%)
2 週に数回程度	8 (0.2%)	5 (0.3%)	3 (0.1%)
3 週に1回程度	14 (0.3%)	11 (0.6%)	3 (0.1%)
4 月に1回程度	25 (0.6%)	18 (0.9%)	7 (0.3%)
5 全くなかった	782 (19.2%)	380 (19.1%)	402 (19.3%)
6 いかなかった	1,672 (41.1%)	820 (41.2%)	852 (41.0%)
7 無回答	1,559 (38.3%)	751 (37.8%)	808 (38.9%)
合 計	4,066	1,988	2,078

家 庭



職 場

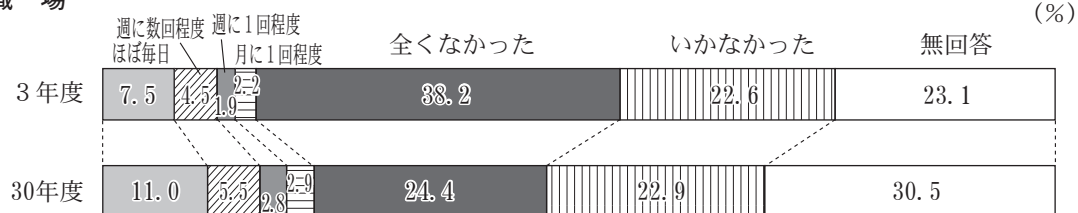

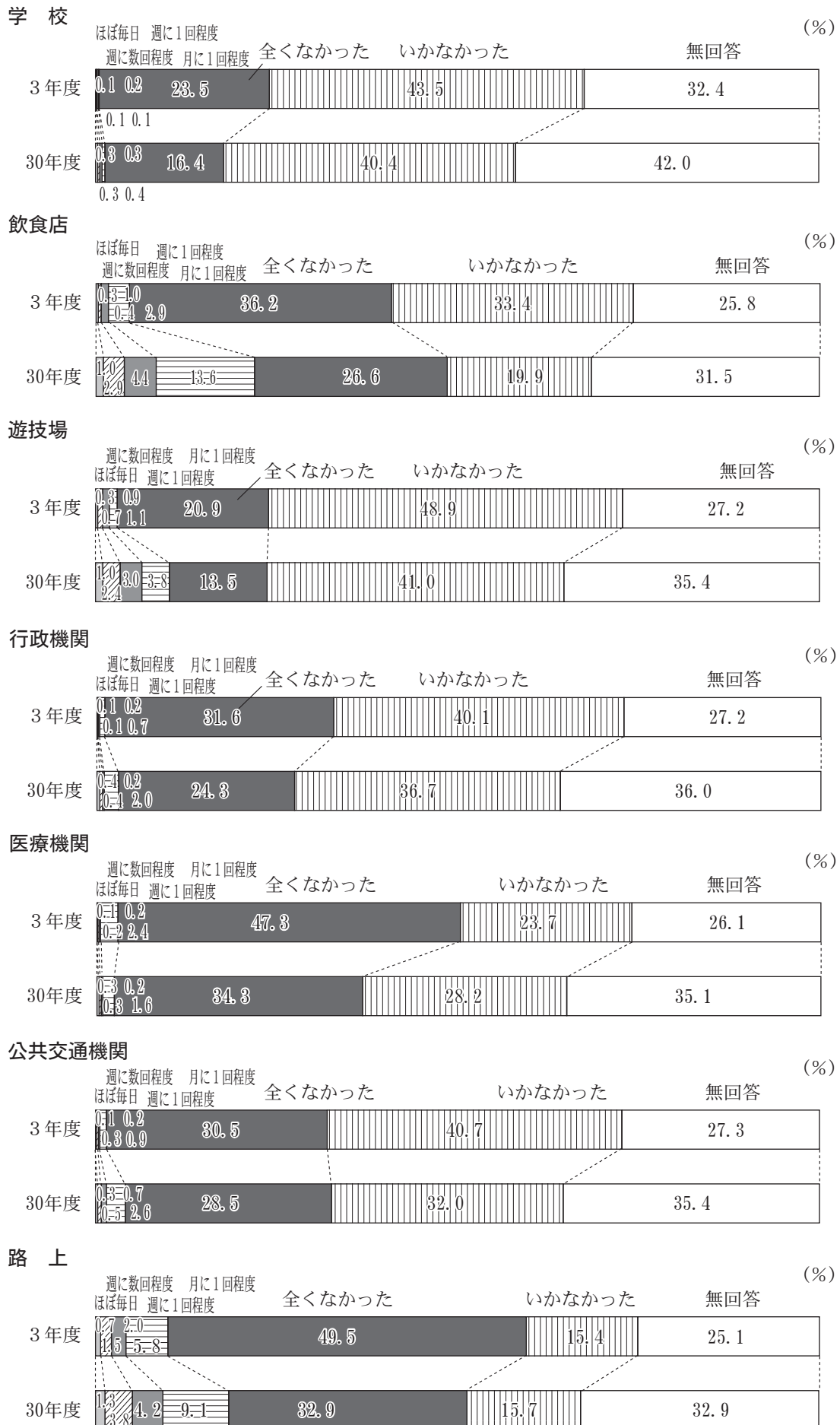

子供が利用する屋外の空間

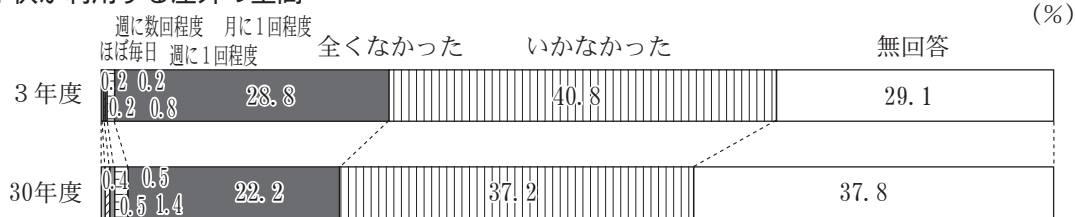

健康増進施設

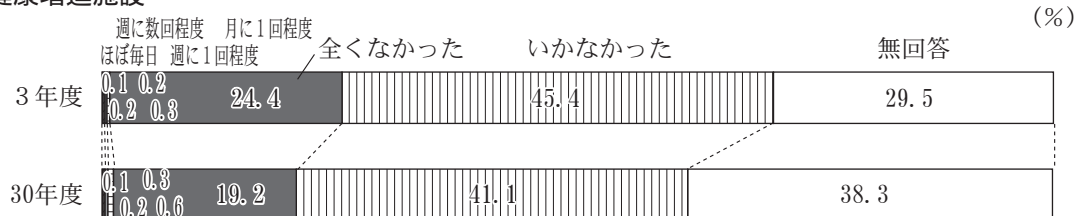

14 「COPD（慢性閉塞性肺疾患）」の認知度（調査票 問14の集計結果）

あなたは、「COPD（慢性閉塞性肺疾患）」という病気を知っていますか。

	全体	男性	女性
1 知っている	1,411 (25.8%)	564 (21.2%)	847 (30.1%)
2 知らない	3,977 (72.7%)	2,067 (77.8%)	1,910 (67.9%)
3 無回答	79 (1.4%)	25 (0.9%)	54 (1.9%)
合計	5,467	2,656	2,811

【平成30年度健康ふくしま21調査】

	全体	男性	女性
1 知っている	1,031 (25.4%)	418 (21.0%)	613 (29.5%)
2 知らない	2,872 (70.6%)	1,500 (75.5%)	1,372 (66.0%)
3 無回答	163 (4.0%)	70 (3.5%)	93 (4.5%)
合計	4,066	1,988	2,078



15 飲酒の状況（満20歳以上対象）（調査票 問15の集計結果）

(1) 飲酒の頻度

あなたは、どのくらいお酒を飲んでいますか。

	全 体	男 性	女 性
1 毎日飲んでいる	997 (19.1%)	783 (30.9%)	214 (8.0%)
2 週に5～6回飲んでいる	264 (5.1%)	188 (7.4%)	76 (2.8%)
3 週に3～4回飲んでいる	301 (5.8%)	191 (7.5%)	110 (4.1%)
4 たまに飲む程度	1,263 (24.2%)	558 (22.0%)	705 (26.2%)
5 以前は飲んでいたが、今は飲んでいない	621 (11.9%)	317 (12.5%)	304 (11.3%)
6 もともと飲まない	1,708 (32.7%)	476 (18.8%)	1,232 (45.9%)
7 無回答	70 (1.3%)	24 (0.9%)	46 (1.7%)
合 計	5,224	2,537	2,687

【平成30年度健康ふくしま21調査】

	全 体	男 性	女 性
1 毎日飲んでいる	721 (18.4%)	581 (30.4%)	140 (7.0%)
2 週に5～6回飲んでいる	191 (4.9%)	142 (7.4%)	49 (2.4%)
3 週に3～4回飲んでいる	264 (6.7%)	178 (9.3%)	86 (4.3%)
4 たまに飲む程度	1,099 (28.0%)	499 (26.1%)	600 (29.9%)
5 以前は飲んでいたが、今は飲んでいない	310 (7.9%)	168 (8.8%)	142 (7.1%)
6 もともと飲まない	1,187 (30.3%)	284 (14.9%)	903 (44.9%)
7 無回答	150 (3.8%)	60 (3.1%)	90 (4.5%)
合 計	3,922	1,912	2,010

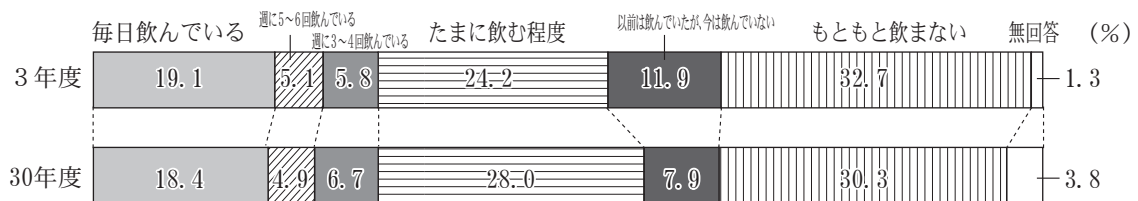

(2) 飲酒の量（調査票 問15付問の集計結果）

あなたが1回に飲む量はどれくらいですか。

	全 体	男 性	女 性
1 極少量	819 (29.0%)	287 (16.7%)	532 (48.1%)
2 1合程度	1,090 (38.6%)	673 (39.1%)	417 (37.7%)
3 2合程度	693 (24.5%)	572 (33.3%)	121 (11.0%)
4 3合以上	206 (7.3%)	180 (10.5%)	26 (2.4%)
5 無回答	17 (0.6%)	8 (0.5%)	9 (0.8%)
合 計	2,825	1,720	1,105

【平成30年度健康ふくしま21調査】

	全 体	男 性	女 性
1 極少量	707 (31.1%)	257 (18.4%)	450 (51.4%)
2 1合程度	833 (36.6%)	541 (38.6%)	292 (33.4%)
3 2合程度	528 (23.2%)	437 (31.2%)	91 (10.4%)
4 3合以上	174 (7.6%)	152 (10.9%)	22 (2.5%)
5 無回答	33 (1.5%)	13 (0.9%)	20 (2.3%)
合 計	2,275	1,400	875

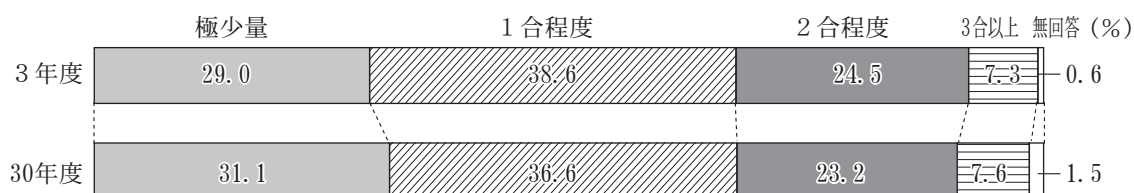

16 定期的な歯科健診の状況 (調査票 問16の集計結果)

あなたは、定期的に歯科健診 (歯石の除去、歯面清掃を含む) を受けていますか。

	全 体	男 性	女 性
1 はい	1,896 (34.7%)	786 (29.6%)	1,110 (39.5%)
2 いいえ	3,522 (64.4%)	1,849 (69.6%)	1,673 (59.5%)
3 無回答	49 (0.9%)	21 (0.8%)	28 (1.0%)
合 計	5,467	2,656	2,811

【平成30年度健康ふくしま21調査】

	全 体	男 性	女 性
1 はい	1,255 (30.9%)	526 (26.5%)	729 (35.1%)
2 いいえ	2,665 (65.5%)	1,395 (70.2%)	1,270 (61.1%)
3 無回答	146 (3.6%)	67 (3.4%)	79 (3.8%)
合 計	4,066	1,988	2,078

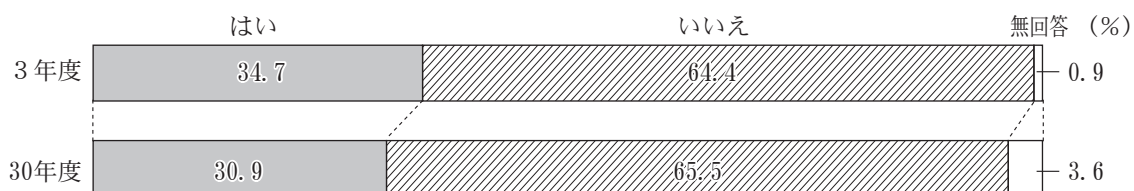

17 歯みがきの状況（調査票 問17の集計結果）

あなたは、毎食後（1日3回以上）歯をみがいていますか。

	全 体	男 性	女 性
1 はい	2,260 (41.3%)	882 (33.2%)	1,378 (49.0%)
2 いいえ	3,175 (58.1%)	1,759 (66.2%)	1,416 (50.4%)
3 無回答	32 (0.6%)	15 (0.6%)	17 (0.6%)
合 計	5,467	2,656	2,811

【平成30年度健康ふくしま21調査】

	全 体	男 性	女 性
1 はい	1,505 (37.0%)	564 (28.4%)	941 (45.3%)
2 いいえ	2,414 (59.4%)	1,353 (68.1%)	1,061 (51.1%)
3 無回答	147 (3.6%)	71 (3.6%)	76 (3.7%)
合 計	4,066	1,988	2,078

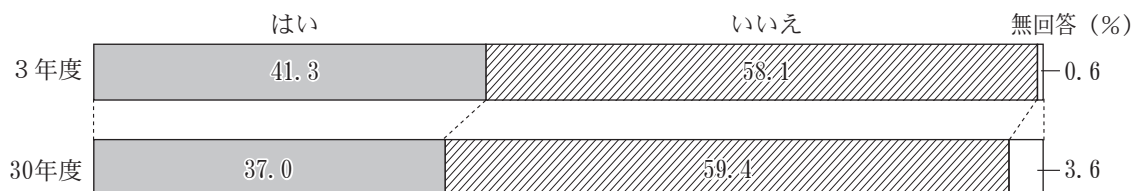

18 外出の状況（調査票 問18の集計結果）

あなたは、積極的に外出するほうですか（買物や散歩を含む）。

	全 体	男 性	女 性
1 はい	3,611 (66.1%)	1,733 (65.2%)	1,878 (66.8%)
2 いいえ	1,794 (32.8%)	894 (33.7%)	900 (32.0%)
3 無回答	62 (1.1%)	29 (1.1%)	33 (1.2%)
合 計	5,467	2,656	2,811

【平成30年度健康ふくしま21調査】

	全 体	男 性	女 性
1 はい	2,742 (67.4%)	1,327 (66.8%)	1,415 (68.1%)
2 いいえ	1,183 (29.1%)	589 (29.6%)	594 (28.6%)
3 無回答	141 (3.5%)	72 (3.6%)	69 (3.3%)
合 計	4,066	1,988	2,078

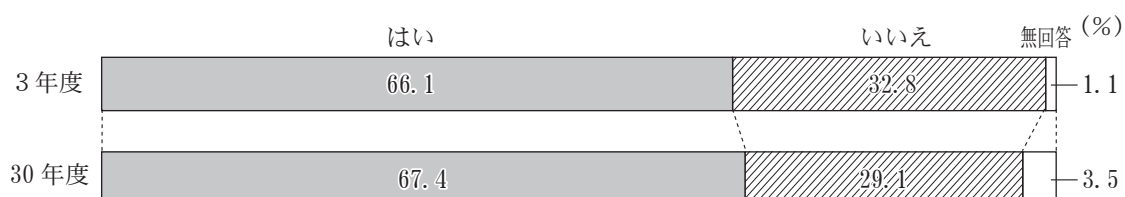

*60歳以上

	全 体	男 性	女 性
1 はい	1,865 (65.8%)	896 (66.2%)	969 (65.4%)
2 いいえ	918 (32.4%)	437 (32.3%)	481 (32.5%)
3 無回答	52 (1.8%)	21 (1.6%)	31 (2.1%)
合 計	2,835	1,354	1,481

【平成30年度健康ふくしま21調査】

*60歳以上

	全 体	男 性	女 性
1 はい	1,465 (66.9%)	723 (68.1%)	742 (65.8%)
2 いいえ	638 (29.1%)	294 (27.7%)	344 (30.5%)
3 無回答	86 (3.9%)	44 (4.1%)	42 (3.7%)
合 計	2,189	1,061	1,128

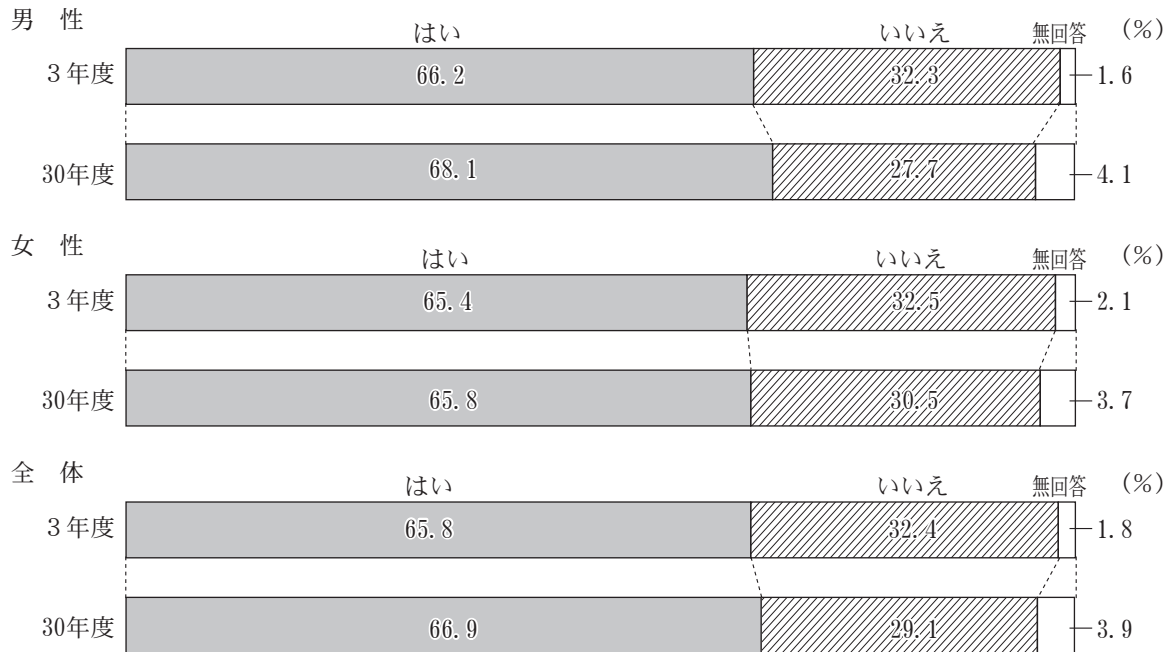

19 地域活動の実施状況（調査票 問19の集計結果）

あなたは、何らかの地域活動を実施していますか。（複数回答有）

【回答者数】 5,467人（男性2,656人、女性2,811人）

	全 体	男 性	女 性
1 老人クラブ	218 (4.0%)	106 (4.0%)	112 (4.0%)
2 健康・スポーツの集まりや団体	572 (10.5%)	273 (10.3%)	299 (10.6%)
3 趣味の集まりや団体	575 (10.5%)	244 (9.2%)	331 (11.8%)
4 社会奉仕団体（ボランティア団体）	236 (4.3%)	125 (4.7%)	111 (3.9%)
5 町内会、自治会の活動	692 (12.7%)	452 (17.0%)	240 (8.5%)
6 宗教団体	79 (1.4%)	36 (1.4%)	43 (1.5%)
7 職場のクラブ活動など	90 (1.6%)	57 (2.1%)	33 (1.2%)
8 その他	96 (1.8%)	44 (1.7%)	52 (1.8%)
9 何も参加していない	3,488 (63.8%)	1,615 (60.8%)	1,873 (66.6%)

【平成30年度健康ふくしま21調査】

【回答者数】 4,066人（男性1,988人、女性2,078人）

	全 体	男 性	女 性
1 老人クラブ	204 (5.0%)	96 (4.8%)	108 (5.2%)
2 健康・スポーツの集まりや団体	521 (12.8%)	249 (12.5%)	272 (13.1%)
3 趣味の集まりや団体	622 (15.3%)	274 (13.8%)	348 (16.7%)
4 社会奉仕団体（ボランティア団体）	238 (5.9%)	137 (6.9%)	101 (4.9%)
5 町内会、自治会の活動	631 (15.5%)	406 (20.4%)	225 (10.8%)
6 宗教団体	83 (2.0%)	32 (1.6%)	51 (2.5%)
7 職場のクラブ活動など	94 (2.3%)	61 (3.1%)	33 (1.6%)
8 その他	133 (3.3%)	64 (3.2%)	69 (3.3%)
9 何も参加していない	2,150 (52.9%)	1,018 (51.2%)	1,132 (54.5%)

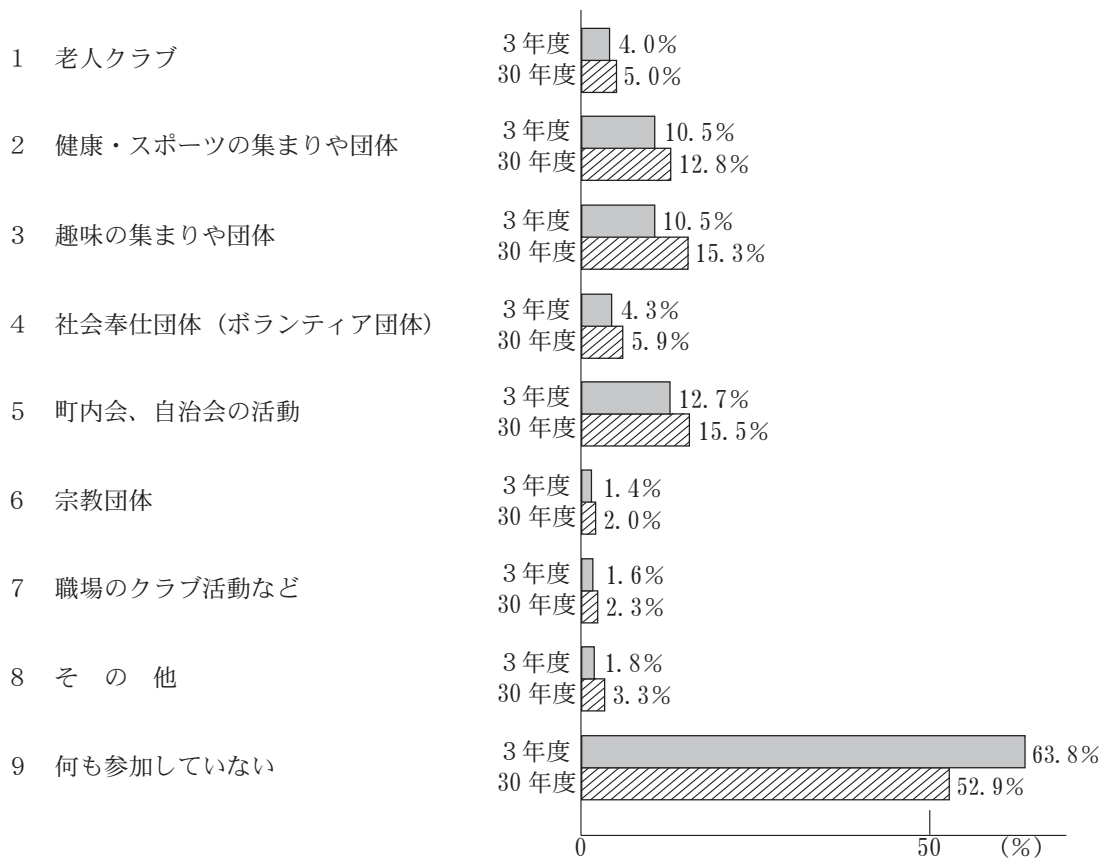

20 睡眠時間の状況 (調査票 問20の集計結果)

あなたのふだんの睡眠時間は、どのくらいですか。

	全体	男性	女性
1 4時間以下	129 (2.4%)	53 (2.0%)	76 (2.7%)
2 5時間位	937 (17.1%)	404 (15.2%)	533 (19.0%)
3 6時間位	1,829 (33.5%)	882 (33.2%)	947 (33.7%)
4 7時間位	1,435 (26.2%)	713 (26.8%)	722 (25.7%)
5 8時間位	915 (16.7%)	485 (18.3%)	430 (15.3%)
6 9時間以上	179 (3.3%)	101 (3.8%)	78 (2.8%)
7 無回答	43 (0.8%)	18 (0.7%)	25 (0.9%)
合計	5,467	2,656	2,811

【平成30年度健康ふくしま21調査】

	全体	男性	女性
1 4時間以下	95 (2.3%)	37 (1.9%)	58 (2.8%)
2 5時間位	723 (17.8%)	344 (17.3%)	379 (18.2%)
3 6時間位	1,372 (33.7%)	665 (33.5%)	707 (34.0%)
4 7時間位	1,058 (26.0%)	513 (25.8%)	545 (26.2%)
5 8時間位	567 (13.9%)	306 (15.4%)	261 (12.6%)
6 9時間以上	115 (2.8%)	56 (2.8%)	59 (2.8%)
7 無回答	136 (3.3%)	67 (3.4%)	69 (3.3%)
合計	4,066	1,988	2,078

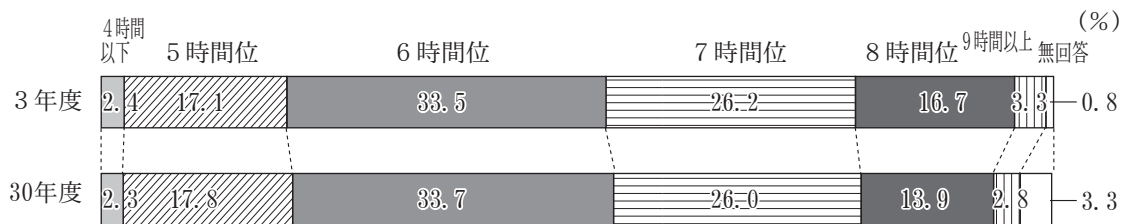

*40～69歳

	全体	男性	女性
1 6時間以下	1,610 (60.5%)	753 (57.3%)	857 (63.6%)
2 7時間以上	1,039 (39.0%)	553 (42.1%)	486 (36.1%)
3 無回答	12 (0.5%)	8 (0.6%)	4 (0.3%)
合計	2,661	1,314	1,347

【平成30年度健康ふくしま21調査】

	全体	男性	女性
1 6時間以下	1,197 (59.5%)	543 (56.2%)	654 (62.6%)
2 7時間以上	760 (37.8%)	398 (41.2%)	362 (34.6%)
3 無回答	55 (2.7%)	26 (2.7%)	29 (2.8%)
合計	2,012	967	1,045

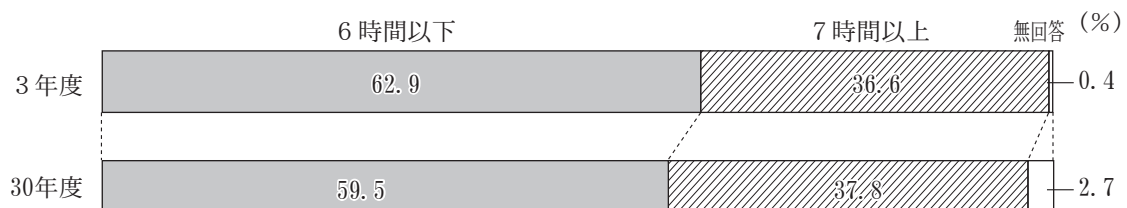

21 疲労の状況（調査票 問21の集計結果）

あなたは、疲れすぎたと感じていますか。			
	全 体	男 性	女 性
1 感じている	2,191 (40.1%)	984 (37.0%)	1,207 (42.9%)
2 あまり感じていない	2,888 (52.8%)	1,485 (55.9%)	1,403 (49.9%)
3 まったく感じていない	300 (5.5%)	156 (5.9%)	144 (5.1%)
4 無回答	88 (1.6%)	31 (1.2%)	57 (2.0%)
合 計	5,467	2,656	2,811

【平成30年度健康ふくしま21調査】			
	全 体	男 性	女 性
1 感じている	1,770 (43.5%)	827 (41.6%)	943 (45.4%)
2 あまり感じていない	1,959 (48.2%)	981 (49.3%)	978 (47.1%)
3 まったく感じていない	168 (4.1%)	101 (5.1%)	67 (3.2%)
4 無回答	169 (4.2%)	79 (4.0%)	90 (4.3%)
合 計	4,066	1,988	2,078

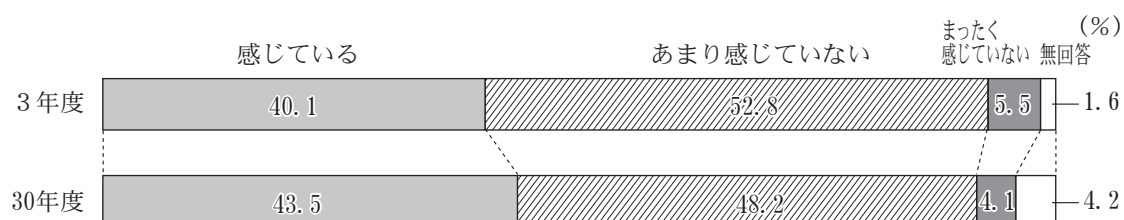

*40～69歳			
	全 体	男 性	女 性
1 感じている	1,141 (42.9%)	525 (40.0%)	616 (45.7%)
2 あまり感じていない	1,374 (51.6%)	714 (54.3%)	660 (49.0%)
3 まったく感じていない	118 (4.4%)	65 (4.9%)	53 (3.9%)
無回答	28 (1.1%)	10 (0.8%)	18 (1.3%)
合 計	2,661	1,314	1,347

【平成30年度健康ふくしま21調査】			
*40～69歳			
	全 体	男 性	女 性
1 感じている	958 (47.6%)	449 (46.4%)	509 (48.7%)
2 あまり感じていない	923 (45.9%)	448 (46.3%)	475 (45.5%)
3 まったく感じていない	61 (3.0%)	34 (3.5%)	27 (2.6%)
無回答	70 (3.5%)	36 (3.7%)	34 (3.3%)
合 計	2,012	967	1,045

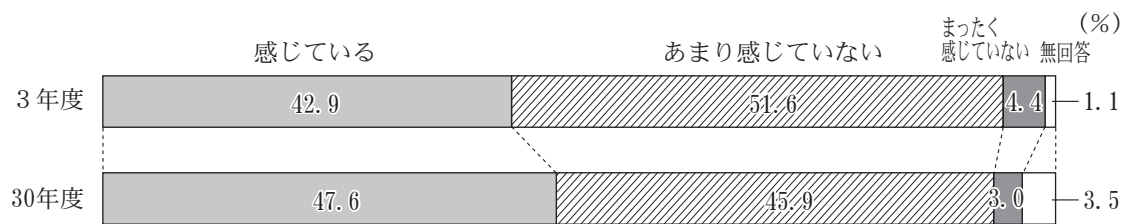

県民健康の日 10月10日

「健康ふくしま21計画」の策定を契機に、「すこやか、いきいき、うつくしま」の創造を目指し、県民一人ひとりが「自分の健康は自分で守る」という自覚と認識を高めるとともに、家族ぐるみ、地域ぐるみの積極的な県民参加を基調とした健康づくりを実践することを目的として「県民健康の日」を制定しました。

令和3年度

健康ふくしま21調査報告書

令和3年度健康ふくしま21調査事務局
公立大学法人 福島県立医科大学 健康増進センター

〒960-1295

福島県福島市光が丘1番地
